



**RULES
FOR THE CLASSIFICATION AND CONSTRUCTION
OF SEA-GOING GAS TANKERS**

July
2026

TEMPORARY RULES

GDAŃSK

RULES FOR THE CLASSIFICATION AND CONSTRUCTION OF SEA-GOING GAS TANKERS developed and edited by Polish Register of Shipping*, hereinafter referred to as PRS, consist of the following Chapters and Appendixes:

- Chapter 1 – General
- Chapter 2 – Ship survival capability and location of cargo tanks
- Chapter 3 – Ship arrangements
- Chapter 4 – Cargo containment
- Chapter 5 – Process pressure vessels and liquid, vapour and pressure piping systems
- Chapter 6 – Materials of construction and quality control
- Chapter 7 – Cargo pressure/temperature control
- Chapter 8 – Vent systems for cargo containment
- Chapter 9 – Cargo containment system atmosphere control
- Chapter 10 – Electrical installations
- Chapter 11 – Fire protection and extinction
- Chapter 12 – Artificial ventilation in the cargo area
- Chapter 13 – Instrumentation and automation systems
- Chapter 14 – Personnel protection
- Chapter 15 – Filling limits for cargo tanks
- Chapter 16 – Use of cargo as fuel
- Chapter 17 – Special requirements
- Chapter 18 – Operation requirements
- Chapter 19 – Summary of minimum requirements
- Appendix 1 – IGC Code Product Data Reporting Form
- Appendix 2 – Model Form of International Certificate of Fitness for the Carriage of Liquefied Gases in Bulk
- Appendix 3 – Example of an Addendum to the International Certificate of Fitness for the Carriage of Liquefied Gases in Bulk
- Appendix 4 – Non-metallic materials
- Appendix 5 – Standard for the use of limit state methodologies in the design of cargo containment systems of novel configuration

These temporary *Rules* were approved by PRS Management Board on 22 June 2026 and enter into force on 1 July 2026.

The requirements of these *Rules* are extended by the following publications:

- Publication 11/P – Environmental Tests on Marine Equipment*
- Publication 51/P – Procedural Requirements for Service Suppliers*
- Publication 5/I – Pipelines Prefabrication*

These temporary *Rules* are being further developed and will be subjected to the assessment by PRS Technical Committee and final approval by PRS Management Board.

Users are invited to provide suggestions and comments on these *Rules* to the address rp@prs.pl.

© Copyright by Polish Register of Shipping, 2026

* Polish Register of Shipping means Polski Rejestr Statków S.A., seated in Gdańsk, al. gen. Józefa Hallera 126, 80-416 Gdańsk, Poland, registered in the Register of Entrepreneurs of the National Court Register, under entry number 0000019880. Polish Register of Shipping, its affiliates and subsidiaries, their respective officers, employees or agents are, individually and collectively, referred to as Polish Register of Shipping or as PRS for short.

CONTENTS

	Page
INTRODUCTION	9
CHAPTER 1	10
1 GENERAL	10
1.1 Application and implementation.....	10
1.2 Definitions	12
1.3 Equivalents.....	17
1.4 Surveys and certification	17
1.5 Classification surveys and certification.....	21
CHAPTER 2	43
2 SHIP SURVIVAL CAPABILITY AND LOCATION OF CARGO TANKS	43
2.1 General.....	43
2.2 Freeboard and stability.....	44
2.3 Damage assumptions.....	45
2.4 Location of cargo tanks.....	46
2.5 Flood assumptions.....	53
2.6 Standard of damage.....	55
2.7 Survival requirements.....	56
CHAPTER 3	57
3 SHIP ARRANGEMENTS	57
3.1 Segregation of the cargo area.....	57
3.2 Accommodation, service and machinery spaces and control stations	58
3.3 Cargo machinery spaces and turret compartments.....	59
3.4 Cargo control rooms.....	60
3.5 Access to spaces in the cargo area	60
3.6 Airlocks	65
3.7 Bilge, ballast and oil fuel arrangements	66
3.8 Bow and stern loading and unloading arrangements.....	66
CHAPTER 4	68
4 CARGO CONTAINMENT	68
4.1 Definitions	68
4.2 Application	68
4.3 Functional requirements	69
4.4 Cargo containment safety principles.....	70
4.5 Secondary barriers in relation to tank types	71
4.6 Design of secondary barriers.....	71
4.7 Partial secondary barriers and primary barrier small leak protection system.....	72
4.8 Supporting arrangements.....	72
4.9 Associated structure and equipment.....	72
4.10 Thermal insulation.....	73
4.11 General.....	73
4.12 Permanent loads	73
4.13 Functional loads.....	73
4.14 Environmental loads.....	75
4.15 Accidental loads.....	76
4.16 General.....	76

4.17 Structural analyses	76
4.18 Design conditions	77
4.19 Materials.....	80
4.20 Construction processes.....	84
4.21 Type A independent tanks.....	87
4.22 Type B independent tanks.....	88
4.23 Type C independent tanks.....	91
4.24 Membrane tanks	116
4.25 Integral tanks	118
4.26 Semi-membrane tanks	119
4.27 Limit state design for novel concepts.....	120
4.28 Guidance notes for Chapter 4.....	120
CHAPTER 5	126
5 PROCESS PRESSURE VESSELS AND LIQUID, VAPOUR AND PRESSURE PIPING SYSTEMS	126
5.1 General.....	126
5.2 System requirements.....	126
5.3 Arrangements for cargo piping outside the cargo area.....	127
5.4 Design pressure.....	128
5.5 Cargo system valve requirements.....	129
5.6 Cargo transfer arrangements.....	130
5.7 Installation requirements.....	131
5.8 Piping fabrication and joining details	132
5.9 Welding, post-weld heat treatment and non-destructive testing.....	133
5.10 Installation requirements for cargo piping outside the cargo area	133
5.11 Piping system component requirements.....	134
5.12 Materials.....	136
5.13 Testing requirements	137
5.14 Liquefied gas cargo and process piping	139
CHAPTER 6	148
6 MATERIALS OF CONSTRUCTION AND QUALITY CONTROL.....	148
6.1 Definitions	148
6.2 Scope and general requirements.....	148
6.3 General test requirements and specifications.....	149
6.4 Requirements for metallic materials.....	151
6.5 Welding of metallic materials and non-destructive testing	157
6.6 Other requirements for construction in metallic materials	160
6.7 Non-metallic materials.....	161
CHAPTER 7	162
7 CARGO PRESSURE/TEMPERATURE CONTROL.....	162
7.1 Methods of control.....	162
7.2 Design of systems.....	162
7.3 Reliquefaction of cargo vapours	162
7.4 Thermal oxidation of vapours	163
7.5 Pressure accumulation systems.....	163
7.6 Liquid cargo cooling.....	163
7.7 Segregation.....	164
7.8 Availability.....	164

CHAPTER 8	165
8 VENT SYSTEMS FOR CARGO CONTAINMENT	165
8.1 General	165
8.2 Pressure relief systems.....	166
8.3 Vacuum protection systems	170
8.4 Sizing of pressure relieving system.....	170
CHAPTER 9	174
9 CARGO CONTAINMENT SYSTEM ATMOSPHERE CONTROL	174
9.1 Atmosphere control within the cargo containment system.....	174
9.2 Atmosphere control within the hold spaces (cargo containment systems other than type C independent tanks)	174
9.3 Environmental control of spaces surrounding type C independent tanks	174
9.4 Inerting	175
9.5 Inert gas production on board.....	175
CHAPTER 10	176
10 ELECTRICAL INSTALLATIONS	176
10.1 Definitions	176
10.2 General requirements.....	176
CHAPTER 11	178
11 FIRE PROTECTION AND EXTINCTION	178
11.1 Fire safety requirements.....	178
11.2 Fire mains and hydrants	178
11.3 Water-spray system	179
11.4 Dry chemical powder fire-extinguishing systems	182
11.5 Enclosed spaces containing cargo handling equipment	183
11.6 Firefighter's outfits	183
CHAPTER 12	185
12 ARTIFICIAL VENTILATION IN THE CARGO AREA	185
12.1 Spaces required to be entered during normal cargo handling operations.....	185
12.2 Spaces not normally entered.....	186
CHAPTER 13	187
13 INSTRUMENTATION AND AUTOMATION SYSTEMS	187
13.1 General	187
13.2 Level indicators for cargo tanks.....	187
13.3 Overflow control	188
13.4 Pressure monitoring	189
13.5 Temperature indicating devices.....	189
13.6 Gas detection	189
13.7 Additional requirements for containment systems requiring a secondary barrier	192
13.8 Automation systems.....	192
13.9 System integration.....	193
CHAPTER 14	195
14 PERSONNEL PROTECTION	195
14.1 Protective equipment.....	195
14.2 First-aid equipment.....	195
14.3 Safety equipment.....	195
14.4 Personal protection requirements for individual products	196

CHAPTER 15	197
15 FILLING LIMITS FOR CARGO TANKS	197
15.1 Definitions	197
15.2 General requirements.....	197
15.3 Default filling limit	197
15.4 Determination of increased filling limit	197
15.5 Maximum loading limit.....	198
15.6 Information to be provided to the master.....	198
CHAPTER 16	199
16 USE OF CARGO AS FUEL	199
16.1 General.....	199
16.2 Use of cargo vapour as fuel	199
16.3 Arrangement of spaces containing gas consumers	199
16.4 Gas fuel supply.....	199
16.5 Gas fuel plant and related storage tanks.....	201
16.6 Special requirements for main boilers.....	202
16.7 Special requirements for gas-fired internal combustion engines	203
16.8 Special requirements for gas turbine	204
16.9 Alternative fuels and technologies	204
CHAPTER 17	206
17 SPECIAL REQUIREMENTS	206
17.1 General.....	206
17.2 Materials of construction	206
17.3 Independent tanks	206
17.4 Refrigeration systems.....	206
17.5 Cargoes requiring type 1G ship.....	207
17.6 Exclusion of air from vapour spaces.....	207
17.7 Moisture control	207
17.8 Inhibition.....	207
17.9 Flame screens on vent outlets	207
17.10 Maximum allowable quantity of cargo per tank.....	208
17.11 Cargo pumps and discharge arrangements	208
17.12 Ammonia	208
17.13 Chlorine.....	209
17.14 Ethylene oxide	210
17.15 Separate piping systems.....	211
17.16 Methyl acetylene-propadiene mixtures	211
17.17 Nitrogen.....	212
17.18 Propylene oxide and mixtures of ethylene oxide-propylene oxide with ethylene oxide content of not more than 30% by weight.....	212
17.19 Vinyl chloride	214
17.20 Mixed C4 cargoes.....	214
17.21 Carbon dioxide: high purity.....	214
17.22 Carbon dioxide: reclaimed quality.....	215
CHAPTER 18	216
18 OPERATING REQUIREMENTS	216
18.1 General.....	216
18.2 Cargo operations manuals.....	216
18.3 Cargo information.....	216

18.4 Suitability for carriage.....	216
18.5 Carriage of cargo at low temperature	216
18.6 Cargo transfer operations.....	216
18.7 Personnel training.....	216
18.8 Entry into enclosed spaces.....	217
18.9 Cargo sampling.....	217
18.10 Cargo emergency shutdown (ESD) system.....	217
18.11 Hot work on or near cargo containment systems.....	220
18.12 Additional operating requirements	220
CHAPTER 19	221
19 SUMMARY OF MINIMUM REQUIREMENTS.....	221
APPENDIX 1 IGC Code Product Data Reporting Form.....	224
APPENDIX 2 Model Form of International Certificate of Fitness for the Carriage of Liquefied Gases in Bulk	225
APPENDIX 3 Example of an addendum to the International Certificate of Fitness for the Carriage of Liquefied Gases in Bulk.....	226
APPENDIX 4 Non-metallic materials	227
APPENDIX 5 Standard for the use of limit state methodologies in the design of cargo containment systems of novel configuration.....	233
List of external reference documents	240
List of amendments as of 1 July 2026.....	243

INTRODUCTION

- 1) *Rules for the Classification and Construction of Sea-going Gas Tankers* (the *Rules*) are based on the IMO *International Code for the Construction and Equipment of Ships Carrying Liquefied Gases in Bulk* (IGC Code) text of which was adopted on 22 May 2014 by Resolution MSC.370(93) and apply to sea-going gas tankers to be assigned additional mark **LIQUIFIED GAS TANKER** in their symbol of class.
- 2) The text of IGC Code requirements has been incorporated and cited in these *Rules* and the text is in blue font. Whenever possible original layout and numbering of the IGC Code paragraphs has been retained. Although provisions of the IGC Code are of statutory nature they are to be complied with for the assignment of PRS class to a gas tanker.
- 3) IMO resolutions and circulars as well as IACS resolutions (Procedural Requirements – PR, Unified Requirements – UR, Unified Interpretations – UI and Recommendations – REC) related to the IGC Code have been incorporated and cited in these *Rules* and they supplement the original provisions of the Code. Unless explicitly provided otherwise IACS Recommendations are non-mandatory.
- 4) Cited text of documents referred to in 3) is always identified with the designation/number of the source document it comes from and marked with dedicated colour: blue for IMO resolutions and circulars, purple for IACS resolutions as well as for “joint” IACS/IMO resolutions (IACS and IMO documents containing the same requirements).
- 5) Whenever the term Classification Society or Society appears in these *Rules* it should be read as PRS. Similarly if the term Recognized Organization (see definition in 1.2.43) appears in these *Rules* it should be read as PRS acting on behalf of an Administration (see definition in 1.2.3).
- 6) If some parts of the cited requirements have been omitted (in principle purely operational requirements), the omitted text is always marked (...). Where necessary, relevant PRS notes or additional requirements have been inserted in the cited text. PRS’ requirements and text are always in black font.
- 7) Ship structures, systems and equipment not covered by these *Rules* or for which there are no explicit requirements in these *Rules* shall comply with the applicable requirements of PRS’ PKiBSM (see definition in 1.2.57).
- 8) Floating production, storage and offloading (FPSO) facilities, which are designed to handle liquefied gases in bulk, do not fall under these *Rules* (the IGC Code). However, designers of such units may consider using these *Rules* (the IGC Code) to the extent that the *Rules* (Code) provides the most appropriate risk mitigation measures for the operations the unit is to perform. Where other more appropriate risk mitigation measures are determined that are contrary to these *Rules* (this Code), they shall take precedence over the *Rules* (Code). (IGC Code, Preamble para. 10)
- 9) Phrases “gas tanker” and “gas carrier” used in these *Rules* have the same meaning.
- 10) Whenever the IGC Code explicitly leaves some matters to the decision or action of Administration, PRS, acting as RO on behalf of an Administration, will handle such matters following provisions of Agreement with the Administration, otherwise PRS will accept decisions made by the Administration itself or by another RO acting on behalf of the Administration.

CHAPTER 1

(IGC Code Chapter 1)

Goal

To provide an international standard for the safe carriage, by sea in bulk, of liquefied gases by laying down the design and construction standards of ships involved in such carriage and the equipment, they shall carry to minimize the risk to the ship, its crew and to the environment, having regard to the nature of the products including flammability, toxicity, asphyxiation, corrosivity, reactivity and low temperature and vapour pressure.

1 GENERAL**1.1 Application and implementation**

1.1.1 These *Rules* apply (The Code applies) to ships regardless of their size, including those of less than 500 gross tonnage, engaged in the carriage of liquefied gases having a vapour pressure exceeding 0.28 MPa absolute at a temperature of 37.8°C and other products, as shown in Chapter 19, when carried in bulk.

1.1.2 Ships covered

1.1.2.1 Unless expressly provided otherwise, these *Rules* apply (the Code applies) to ships whose keels are laid, or which are at a similar stage of construction where:

- .1 construction identifiable with the ship begins; and
- .2 assembly of that ship has commenced, comprising at least 50 tonnes or 1% of the estimated mass of all structural material, whichever is less,

on or after 1 July 2016.

The following requirements apply to gas tankers other than those mentioned above:

- .1 ships constructed from 1 July 1986 to 1 July 2016 shall comply with the *International Code for the Construction and Equipment of Ships Carrying Liquefied Gases in Bulk* (IGC Code) text of which was adopted on 17 June 1983 by Resolution MSC.5(48);
- .2 ships constructed before 1 July 1986 should at least comply with the *Code for the Construction and Equipment of Ships Carrying Liquefied Gases in Bulk* (GC Code), as amended, text of which was adopted on 12 November 1975 by Resolution A.328(IX).

1.1.2.2 For the purpose of these *Rules* (the Code), the expression "ships constructed" means ships the keels of which are laid or which are at a similar stage of construction.

1.1.2.3 (...).

1.1.3 A ship, irrespective of the date of construction, which is converted to a gas carrier on or after 1 July 2016, shall be treated as a gas carrier constructed on the date on which such conversion commences.

1.1.4 Cargo carriage restrictions

1.1.4.1 When cargo tanks contain products for which these *Rules* require (the Code requires) a type 1G ship, neither flammable liquids having a flashpoint of 60°C (closed cup test) or less, nor flammable products listed in Chapter 19, shall be carried in tanks located within the protective zones described in 2.4.1.1.

1.1.4.2 Similarly, when cargo tanks contain products for which these *Rules* require (the Code requires) a type 2G/2PG ship, the flammable liquids as described in 1.1.4.1, shall not be carried in tanks located within the protective zones described in 2.4.1.2.

1.1.4.3 In each case, for cargo tanks loaded with products for which these *Rules* require (the Code requires) a type 1G or 2G/2PG ship, the restriction applies to the protective zones within the longitudinal extent of the hold spaces for those tanks.

1.1.4.4 The flammable liquids and products described in 1.1.4.1 may be carried within these protective zones when the quantity of products retained in the cargo tanks, for which these *Rules* require (the Code requires) a type 1G or 2G/2PG ship is solely used for cooling, circulation or fuelling purposes.

1.1.5 Except as provided in 1.1.7.1, when it is intended to carry products covered by these *Rules* (the Code) and products covered by the *International Code for the Construction and Equipment of Ships Carrying Dangerous Chemicals in Bulk* (IBC Code), adopted by resolution MSC.4(48), as may be amended by the Organization, the ship shall comply with the requirements of both these *Rules* and IBC Code (both Codes) appropriate to the products carried.

1.1.6 Carriage of products not listed in the IGC Code

1.1.6.1 Where it is proposed to carry products that may be considered to come within the scope of this Code that are not at present designated in Chapter 19, the Administration and the port Administrations involved in such carriage shall establish a Tripartite Agreement based on a provisional assessment and lay down preliminary suitable conditions of carriage based on the principles of the Code.

1.1.6.2 For the evaluation of such products, the manufacturer of the product shall submit to the Administration a completed assessment form (see appendix 1), which includes the proposed ship type and carriage requirements.

1.1.6.3 When a provisional assessment for a pure or technically pure product has been completed and agreed with the other parties, the Administration shall submit the assessment form and a proposal for a new and complete entry in the IGC Code, to the relevant sub-committee of the Organization (see Appendix 1).

1.1.6.4 After provisional assessment by Tripartite Agreement and express or tacit agreement has been established, an addendum to the relevant ship's certificate may be issued (see Appendix 3).

1.1.7 Applicability of the IGC and IBC Code

1.1.7.1 The requirements of these *Rules* (this Code) shall take precedence when a ship is designed and constructed for the carriage of the following products:

- .1 those listed exclusively in Chapter 19 of these *Rules* (the Code); and
- .2 one or more of the products that are listed both in these *Rules* (the Code) and in the IBC Code (*International Bulk Chemical Code*). These products are marked with an asterisk in column "a" in the table contained within Chapter 19.

1.1.7.2 When a ship is intended to exclusively carry one or more of the products referred to in 1.1.7.1.2, the requirements of the IBC Code (*International Bulk Chemical Code*), as amended, shall apply.

1.1.8 The ship's compliance with the requirements of the IGC Code (*International Gas Carrier Code*) shall be shown by its *International Certificate of Fitness for the Carriage of Liquefied Gases in Bulk*, as described in 1.4. Compliance with the amendments to the Code, as appropriate, shall also be indicated in the *International Certificate of Fitness for the Carriage of Liquefied Gases in Bulk*.

1.1.9 Where reference is made in **these Rules** (the Code) to a paragraph, all the provisions of the subparagraph of that designation shall apply.

1.1.10 When a ship is intended to operate for periods at a fixed location in a re-gasification and gas discharge mode or a gas receiving, processing, liquefaction and storage mode, the Administration and port Administrations involved in the operation shall take appropriate steps to ensure implementation of the provisions of **these Rules** (the Code) as are applicable to the proposed arrangements. Furthermore, additional requirements shall be established based on the principles of **these Rules** (the Code) as well as recognized standards that address specific risks not envisaged by it. Such risks may include, but not be limited to:

- .1 fire and explosion;
- .2 evacuation;
- .3 extension of hazardous areas;
- .4 pressurized gas discharge to shore;
- .5 high-pressure gas venting;
- .6 process upset conditions;
- .7 storage and handling of flammable refrigerants;
- .8 continuous presence of liquid and vapour cargo outside the cargo containment system;
- .9 tank over-pressure and under-pressure;
- .10 ship-to-ship transfer of liquid cargo; and
- .11 collision risk during berthing manoeuvres.

1.1.11 Where a risk assessment or study of similar intent is utilized within **these Rules** (the Code), the results shall also include, but not be limited to, the following as evidence of effectiveness:

- .1 description of methodology and standards applied;
- .2 potential variation in scenario interpretation or sources of error in the study;
- .3 validation of the risk assessment process by an independent and suitable third party;
- .4 quality system under which the risk assessment was developed;
- .5 the source, suitability and validity of data used within the assessment
- .6 the knowledge base of persons involved within the assessment;
- .7 system of distribution of results to relevant parties; and
- .8 validation of results by an independent and suitable third party.

1.1.12 Although the IGC Code is legally treated as a mandatory instrument under the SOLAS Convention, the provisions of section 4.28 and appendices 1 and 4 of the Code and **these Rules** are recommendatory or informative.

1.2 Definitions

Except where expressly provided otherwise, the following definitions apply to **these Rules** (the Code). Additional definitions are provided in chapters throughout **these Rules** (the Code).

1.2.1 Accommodation spaces are those spaces used for public spaces, corridors, lavatories, cabins, offices, hospitals, cinemas, games and hobby rooms, barber shops, pantries without cooking appliances and similar spaces.

1.2.2 "A" class divisions are divisions as defined in *PKiBSM, Part V, 1.2.2* (regulation II-2/3.2 of the SOLAS Convention).

1.2.3 Administration means the Government of the State whose flag the ship is entitled to fly. For *Administration (port)*, see *port Administration*.

1.2.4 Anniversary date means the day and the month of each year that will correspond to the date of expiry of the *International Certificate of Fitness for the Carriage of Liquefied Gases in Bulk*.

1.2.5 Boiling point is the temperature at which a product exhibits a vapour pressure equal to the atmospheric pressure.

1.2.6 Breadth (B) means the maximum breadth of the ship, measured amidships to the moulded line of the frame in a ship with a metal shell, and to the outer surface of the hull in a ship with a shell of any other material. The breadth (*B*) shall be measured in metres.

1.2.7 Cargo area is that part of the ship which contains the cargo containment system and cargo pump and compressor rooms and includes the deck areas over the full length and breadth of the part of the ship over these spaces. Where fitted, the cofferdams, ballast or void spaces at the after end of the aftermost hold space or at the forward end of the foremost hold space are excluded from the cargo area.

1.2.8 Cargo containment system is the arrangement for containment of cargo including, where fitted, a primary and secondary barrier, associated insulation and any intervening spaces, and adjacent structure, if necessary, for the support of these elements. If the secondary barrier is part of the hull structure, it may be a boundary of the hold space.

1.2.9 Cargo control room is a space used in the control of cargo handling operations.

1.2.10 Cargo machinery spaces are the spaces where cargo compressors or pumps, cargo processing units, are located, including those supplying gas fuel to the engine-room.

1.2.11 Cargo pumps are pumps used for the transfer of liquid cargo including main pumps, booster pumps, spray pumps, etc.

1.2.12 Cargoes are products listed in Chapter 19, that are carried in bulk by ships subject to these *Rules* (the Code).

1.2.13 Cargo service spaces are spaces within the cargo area, used for workshops, lockers and store-rooms that are of more than 2 m² in area.

1.2.14 Cargo tank is the liquid-tight shell designed to be the primary container of the cargo and includes all such containment systems whether or not they are associated with the insulation or/and the secondary barriers.

1.2.15 Closed loop sampling is a cargo sampling system that minimizes the escape of cargo vapour to the atmosphere by returning product to the cargo tank during sampling.

1.2.16 Cofferdam is the isolating space between two adjacent steel bulkheads or decks. This space may be a void space or a ballast space.

1.2.17 Control stations are those spaces in which ship's radio, main navigating equipment or the emergency source of power is located or where the fire-recording or fire control equipment is centralized. This does not include special fire control equipment, which can be most practically located in the cargo area.

1.2.18 Flammable products are those identified by an "F" in column "f" in the table of Chapter 19.

1.2.19 Flammability limits are the conditions defining the state of fuel-oxidant mixture at which application of an adequately strong external ignition source is only just capable of producing flammability in a given test apparatus.

1.2.20 FSS Code is the Fire Safety Systems Code meaning the *International Code for Fire Safety Systems*, adopted by the Maritime Safety Committee of the Organization by resolution MSC.98(73), as amended.

1.2.21 Gas carrier or **gas tanker** is a cargo ship constructed or adapted and used for the carriage in bulk of any liquefied gas or other products listed in the table of Chapter 19.

1.2.22 Gas combustion unit (GCU) is a means of disposing excess cargo vapour by thermal oxidation.

1.2.23 Gas consumer is any unit within the ship using cargo vapour as a fuel.

1.2.24 Hazardous area is an area in which an explosive gas atmosphere is, or may be expected to be present, in quantities that require special precautions for the construction, installation and use of electrical equipment. When a gas atmosphere is present, the following hazards may also be present: toxicity, asphyxiation, corrosivity, reactivity and low temperature. These hazards shall also be taken into account and additional precautions for the ventilation of spaces and protection of the crew will need to be considered. Examples of hazardous areas include, but are not limited to, the following ¹⁾:

- .1 the interiors of cargo containment systems and any pipework of pressure-relief or other venting systems for cargo tanks, pipes and equipment containing the cargo;
- .2 interbarrier spaces;
- .3 hold spaces where the cargo containment system requires a secondary barrier;
- .4 hold spaces where the cargo containment system does not require a secondary barrier;
- .5 a space separated from a hold space by a single gastight steel boundary where the cargo containment system requires a secondary barrier;
- .6 cargo machinery spaces;
- .7 areas on open deck, or semi-enclosed spaces on open deck, within 3 m of possible sources of gas release, such as cargo valve, cargo pipe flange, cargo machinery space ventilation outlet, etc.;
- .8 areas on open deck, or semi-enclosed spaces on open deck within 1.5 m of cargo machinery space entrances, cargo machinery space ventilation inlets;
- .9 areas on open deck over the cargo area and 3 m forward and aft of the cargo area on the open deck up to a height of 2.4 m above the weather deck;
- .10 an area within 2.4 m of the outer surface of a cargo containment system where such surface is exposed to the weather;
- .11 enclosed or semi-enclosed spaces in which pipes containing cargoes are located, except those where pipes containing cargo products for boil-off gas fuel burning systems are located;
- .12 an enclosed or semi-enclosed space having a direct opening into any hazardous area;
- .13 void spaces, cofferdams, trunks, passageways and enclosed or semi-enclosed spaces, adjacent to, or immediately above or below, the cargo containment system;
- .14 areas on open deck or semi-enclosed spaces on open deck above and in the vicinity of any vent riser outlet, within a vertical cylinder of unlimited height and 6 m radius centred upon the centre of the outlet and within a hemisphere of 6 m radius below the outlet; and

.15 areas on open deck within spillage containment surrounding cargo manifold valves and 3 m beyond these up to a height of 2.4 m above deck.

¹⁾ Refer to Chapter 10 for a separate list of examples and classification of hazardous areas for the purpose of selection and design of electrical installations.

1.2.25 *Non-hazardous area* is an area other than a hazardous area.

1.2.26 *Hold space* is the space enclosed by the ship's structure in which a cargo containment system is situated.

1.2.27 *IBC Code* means the *International Code for the Construction and Equipment of Ships carrying Dangerous Chemicals in Bulk*, adopted by the Maritime Safety Committee of the Organization by resolution MSC.4(48), as amended.

1.2.28 *Independent* means that a piping or venting system, for example, is in no way connected to another system and that there are no provisions available for the potential connection to other systems.

1.2.29 *Insulation space* is the space, which may or may not be an interbarrier space, occupied wholly or in part by insulation.

1.2.30 *Interbarrier space* is the space between a primary and a secondary barrier, whether or not completely or partially occupied by insulation or other material.

1.2.31 *Length (L)* is the length as defined in the *International Convention on Load Lines* in force.

1.2.32 *Machinery spaces of category A* are those spaces, and trunks to those spaces, which contain either:

- .1 internal combustion machinery used for main propulsion; or
- .2 internal combustion machinery used for purposes other than main propulsion where such machinery has, in the aggregate, a total power output of not less than 375 kW; or
- .3 any oil-fired boiler or oil fuel unit or any oil-fired equipment other than boilers, such as inert gas generators, incinerators, etc.

1.2.33 *Machinery spaces* are machinery spaces of category A and other spaces containing propelling machinery, boilers, oil fuel units, steam and internal-combustion engines, generators and major electrical machinery, oil filling stations, refrigerating, stabilizing, ventilation and air-conditioning machinery, and similar spaces and the trunks to such spaces.

1.2.34 *MARVS* is the maximum allowable relief valve setting of a cargo tank (gauge pressure).

1.2.35 *Nominated surveyor* is a surveyor nominated/appointed by an Administration to enforce the provisions of the SOLAS Convention regulations with regard to inspections and surveys and the granting of exemptions therefrom.

1.2.36 *Oil fuel unit* is the equipment used for the preparation of oil fuel for delivery to an oil-fired boiler, or equipment used for the preparation for delivery of heated oil to an internal combustion engine, and includes any oil pressure pumps, filters and heaters dealing with oil at a pressure of more than 0.18 MPa gauge.

1.2.37 *Organization* is the International Maritime Organization (IMO).

1.2.38 *Permeability* of a space means the ratio of the volume within that space which is assumed to be occupied by water to the total volume of that space.

1.2.39 Port Administration means the appropriate authority of the country for the port where the ship is loading or unloading.

1.2.40 Primary barrier is the inner element designed to contain the cargo when the cargo containment system includes two boundaries.

1.2.41 Products is the collective term used to cover the list of gases indicated in Chapter 19 of these *Rules* (this Code).

1.2.42 Public spaces are those portions of the accommodation that are used for halls, dining rooms, lounges and similar permanently enclosed spaces.

1.2.43 Recognized organization is an organization authorized by an Administration in accordance with SOLAS regulation XI-1/1.

Note:

PRS is recognized organization for more than 40 flag States. For details see <https://prs.pl/en/about-us/>

1.2.44 Recognized standards are applicable international or national standards acceptable to the Administration, or standards laid down and maintained by the recognized organization.

1.2.45 Relative density is the ratio of the mass of a volume of a product to the mass of an equal volume of fresh water.

1.2.46 Secondary barrier is the liquid-resisting outer element of a cargo containment system, designed to afford temporary containment of any envisaged leakage of liquid cargo through the primary barrier and to prevent the lowering of the temperature of the ship's structure to an unsafe level. Types of secondary barrier are more fully defined in Chapter 4.

1.2.47 Separate systems are those cargo piping and vent systems that are not permanently connected to each other.

1.2.48 Service spaces are those used for galleys, pantries containing cooking appliances, lockers, mail and specie rooms, store-rooms, workshops other than those forming part of the machinery spaces, and similar spaces and trunks to such spaces.

1.2.49 SOLAS Convention means the International Convention for the Safety of Life at Sea, 1974, as amended.

1.2.50 Tank cover is the protective structure intended to either protect the cargo containment system against damage where it protrudes through the weather deck or to ensure the continuity and integrity of the deck structure.

1.2.51 Tank dome is the upward extension of a portion of a cargo tank. In the case of below-deck cargo containment systems, the tank dome protrudes through the weather deck or through a tank cover.

1.2.52 Thermal oxidation method means a system where the boil-off vapours are utilized as fuel for shipboard use or as a waste heat system subject to the provisions of Chapter 16 or a system not using the gas as fuel complying with these *Rules* (this Code).

1.2.53 Toxic products are those defined by a "T" in column "f" in the table of Chapter 19.

1.2.54 Turret compartments are those spaces and trunks that contain equipment and machinery for retrieval and release of the disconnectable turret mooring system, high-pressure hydraulic operating systems, fire protection arrangements and cargo transfer valves.

1.2.55 *Vapour pressure* is the equilibrium pressure of the saturated vapour above the liquid, expressed in Pascals (Pa) absolute at a specified temperature.

1.2.56 *Void space* is an enclosed space in the cargo area external to a cargo containment system, other than a hold space, ballast space, oil fuel tank, cargo pumps or compressor room, or any space in normal use by personnel.

1.2.57 *PKiBSM* are PRS' *Rules for the Classification and Construction of Sea-going Ships*.

1.3 Equivalentents

1.3.1 Where these *Rules* require (the Code requires) that a particular fitting, material, appliance, apparatus, item of equipment or type thereof shall be fitted or carried in a ship, or that any particular provision shall be made, or any procedure or arrangement shall be complied with, PRS whether acting as RO or as a classification society only may allow, upon agreement with the ship's flag State Administration, (the Administration may allow) any other fitting, material, appliance, apparatus, item of equipment or type thereof to be fitted or carried, or any other provision, procedure or arrangement to be made in that ship, if it is satisfied by trial thereof or otherwise that such fitting, material, appliance, apparatus, item of equipment or type thereof, or that any particular provision, procedure or arrangement, is at least as effective as that required by these *Rules* (the Code). However, the Administration may not allow operational methods or procedures to be made as an alternative to a particular fitting, material, appliance, apparatus, item of equipment, or type thereof that is prescribed by the Code, unless such a substitution is specifically allowed by the Code.

1.3.2 When the Administration so allows, any fitting, material, appliance, apparatus, item of equipment, or type thereof, or provision, procedure or arrangement or novel design or application to be substituted, it shall communicate to the Organization the particulars thereof, together with a report on the evidence submitted, so that the Organization may circulate the same to other Contracting Governments to the SOLAS Convention for the information of their officers.

1.4 Surveys and certification

Note:

Surveys and certification activities described in 1.4.1 to 1.4.6 serve for statutory purposes and they are listed here for information only. PRS will perform these activities when acting as RO on behalf of an Administration. Classification surveys and certification activities for the assignment and maintenance of PRS class – see 1.5.

1.4.1 Survey procedure

1.4.1.1 The survey of ships, so far as regards the enforcement of the provisions of the Code and granting of exemptions therefrom, shall be carried out by officers of the Administration. The Administration may, however, entrust the surveys either to surveyors nominated for the purpose or to organizations recognized by it.

1.4.1.2 The recognized organization, referred to in 1.2.43, shall comply with the provisions of the SOLAS Convention and with the *Code for recognized organizations* (RO Code).

1.4.1.3 The Administration nominating surveyors or recognizing organizations to conduct surveys shall, as a minimum, empower any nominated surveyor or recognized organization to:

- .1 require repairs to a ship; and
- .2 carry out surveys if requested by the appropriate authorities of a port State.

The Administration shall notify the Organization of the specific responsibilities and conditions of the authority delegated to nominated surveyors or recognized organizations, for circulation to the Contracting Governments.

1.4.1.4 When a nominated surveyor or recognized organization determines that the condition of a ship or its equipment does not correspond substantially with the particulars of the *International Certificate of Fitness for the Carriage of Liquefied Gases in Bulk*, or is such that the ship is not fit to proceed to sea without danger to the ship or persons on board, or without presenting unreasonable threat of harm to the marine environment, the surveyor or organization shall immediately ensure that corrective action is taken and shall, in due course, notify the Administration. If such corrective action is not taken, the certificate shall be withdrawn and the Administration shall be notified immediately. If the ship is in a port of another Contracting Government, the appropriate authorities of the port State shall be notified immediately. When an officer of the Administration, a nominated surveyor or a recognized organization has notified the appropriate authorities of the port State, the Government of the port State concerned shall give the officer, surveyor or organization any necessary assistance to carry out their obligations under this paragraph. When applicable, the Government of the port State concerned shall take such steps as will ensure that the ship does not sail until it can proceed to sea or leave the port for the purpose of proceeding to the nearest appropriate repair yard available without danger to the ship or persons on board or without presenting an unreasonable threat of harm to the marine environment.

1.4.1.5 In every case, the Administration shall guarantee the completeness and efficiency of the survey and shall undertake to ensure the necessary arrangements to satisfy this obligation.

1.4.2 Survey requirements

The structure, equipment, fittings, arrangements and material (other than items in respect of which a Cargo Ship Safety Construction Certificate, Cargo Ship Safety Equipment Certificate and Cargo Ship Safety Radio Certificate; or Cargo Ship Safety Certificate, required by the SOLAS Convention, are issued) of a gas carrier shall be subjected to the following surveys:

- .1** An initial survey before the ship is put in service or before the *International Certificate of Fitness for the Carriage of Liquefied Gases in Bulk* is issued for the first time, which shall include a complete examination of its structure, equipment, fittings, arrangements and materials in so far as the ship is covered by the Code. This survey shall be such as to ensure that the structure, equipment, fittings, arrangements and material fully comply with the applicable provisions of the Code.
- .2** A renewal survey at intervals specified by the Administration, but not exceeding five years, except where regulation 1.4.6.2.1, 1.4.6.5, 1.4.6.6 or 1.4.6.7 is applicable. The renewal survey shall be such as to ensure that the structure, equipment, fittings, arrangements and material fully comply with the applicable provisions of the Code.
- .3** An intermediate survey within three months before or after the second anniversary date, or within three months before or after the third anniversary date of the certificate, which shall take the place of one of the annual surveys specified in 1.4.2.4. The intermediate survey shall be such as to ensure that the safety equipment, and other equipment, and associated pump and piping systems fully comply with the applicable provisions of the Code and are in good working order. Such intermediate surveys shall be endorsed on the certificate issued under 1.4.4 or 1.4.5.
- .4** An annual survey within three months before or after each anniversary date of the certificate, including a general inspection of the structure, equipment, fittings, arrangements and material referred to in 1.4.2.1 to ensure that they have been maintained

in accordance with 1.4.3 and that they remain satisfactory for the service for which the ship is intended. Such annual surveys shall be endorsed on the certificate issued under 1.4.4 or 1.4.5.

- .5 An additional survey, either general or partial according to the circumstances, shall be made when required after an investigation prescribed in 1.4.3.3, or whenever any important repairs or renewals are made. Such a survey shall ensure that the necessary repairs or renewals have been effectively made, that the materials and workmanship of such repairs or renewals are satisfactory, and that the ship is fit to proceed to sea without danger to the ship or persons on board or without presenting unreasonable threat of harm to the marine environment.

1.4.3 Maintenance of conditions after survey

1.4.3.1 The condition of the ship and its equipment shall be maintained to conform with the provisions of the Code and to ensure that the ship will remain fit to proceed to sea without danger to the ship or persons on board or without presenting unreasonable threat of harm to the marine environment.

1.4.3.2 After any survey of the ship, as described in 1.4.2, has been completed, no change shall be made in the structure, equipment, fittings, arrangements and material covered by the survey without the sanction of the Administration, except by direct replacement.

1.4.3.3 Whenever an accident occurs to a ship or a defect is discovered, either of which affects the safety of the ship or the efficiency or completeness of its life-saving appliances or other equipment covered by the Code, the master or owner of the ship shall report at the earliest opportunity to the Administration, the nominated surveyor or recognized organization responsible for issuing the certificate, who shall cause investigations to be initiated to determine whether a survey, as required by 1.4.2.5, is necessary. If the ship is in a port of another Contracting Government, the master or owner shall also report immediately to the appropriate authorities of the port State and the nominated surveyor or recognized organization shall ascertain that such a report has been made.

1.4.4 Issue and endorsement of an International Certificate of Fitness for the Carriage of Liquefied Gases in Bulk

1.4.4.1 An *International Certificate of Fitness for the Carriage of Liquefied Gases in Bulk* shall be issued, after an initial or renewal survey, to a gas carrier engaged on international voyages that comply with the relevant provisions of the Code.

1.4.4.2 Such a certificate shall be drawn up in the form corresponding to the model given in appendix 2. If the language used is not English, French or Spanish, the text shall include a translation into one of these languages.

1.4.4.3 The certificate issued under the provisions of this section shall be available on board for examination at all times.

1.4.4.4 Notwithstanding any other provisions of the amendments to the Code, adopted by the Maritime Safety Committee by resolution MSC.17(58), any *International Certificate of Fitness for the Carriage of Liquefied Gases in Bulk* that is current when these amendments enter into force shall remain valid until it expires under the terms of this Code prior to the amendments entering into force.

1.4.5 Issue and endorsement of an International Certificate of Fitness for the Carriage of Liquefied Gases in Bulk by another Government

1.4.5.1 A Contracting Government to the SOLAS Convention may, at the request of another Contracting Government, cause a ship entitled to fly the flag of the other State to be surveyed and, if satisfied that the requirements of the Code are complied with, issue or authorize the issue of the *International Certificate of Fitness for the Carriage of Liquefied Gases in Bulk* to the ship and, where appropriate, endorse or authorize the endorsement of the certificate on board the ship in accordance with the Code. Any certificate so issued shall contain a statement to the effect that it has been issued at the request of the Government of the State whose flag the ship is entitled to fly.

1.4.6 Duration and validity of an International Certificate of Fitness for the Carriage of Liquefied Gases in Bulk

1.4.6.1 An *International Certificate of Fitness for the Carriage of Liquefied Gases in Bulk* shall be issued for a period specified by the Administration, which shall not exceed five years.

1.4.6.2 Certificate validity after renewal survey

1.4.6.2.1 Notwithstanding the provisions of 1.4.6.1, when the renewal survey is completed within three months before the expiry date of the existing certificate, the new certificate shall be valid from the date of completion of the renewal survey to a date not exceeding five years from the date of expiry of the existing certificate.

1.4.6.2.2 When the renewal survey is completed after the expiry date of the existing certificate, the new certificate shall be valid from the date of completion of the renewal survey to a date not exceeding five years from the date of expiry of the existing certificate.

1.4.6.2.3 When the renewal survey is completed more than three months before the expiry date of the existing certificate, the new certificate shall be valid from the date of completion of the renewal survey to a date not exceeding five years from the date of completion of the renewal survey.

1.4.6.3 If a certificate is issued for a period of less than five years, the Administration may extend the validity of the certificate beyond the expiry date to the maximum period specified in 1.4.6.1, provided that the surveys referred to in regulations 1.4.2.3 and 1.4.2.4, applicable when a certificate is issued for a period of five years, are carried out as appropriate.

1.4.6.4 If a renewal survey has been completed and a new certificate cannot be issued or placed on board the ship before the expiry date of the existing certificate, the person or organization authorized by the Administration may endorse the existing certificate. Such a certificate shall be accepted as valid for a further period which shall not exceed five months from the expiry date.

1.4.6.5 If a ship is not in a port in which it is to be surveyed at the time when a certificate expires, the Administration may extend the period of validity of the certificate. However, the extension shall be granted only for the purpose of allowing the ship to complete its voyage to the port in which it is to be surveyed, and then only in cases where it appears proper and reasonable to do so.

1.4.6.6 A certificate, issued to a ship engaged on short voyages, that has not been extended under the foregoing provisions of this section may be extended by the Administration for a period of grace of up to one month from the date of expiry stated on it. When the renewal survey is completed, the new certificate shall be valid to a date not exceeding five years from the date of expiry of the existing certificate before the extension was granted.

1.4.6.7 In special circumstances, as determined by the Administration, a new certificate need not be dated from the date of expiry of the existing certificate as required by 1.4.6.2.2, 1.4.6.5 or 1.4.6.6. In these special circumstances, the new certificate shall be valid to a date not exceeding five years from the date of completion of the renewal survey.

1.4.6.8 If an annual or intermediate survey is completed before the period specified in 1.4.2, then:

- .1** the anniversary date shown on the certificate shall be amended by endorsement to a date that shall not be more than three months later than the date on which the survey was completed;
- .2** the subsequent annual or intermediate survey required by 1.4.2 shall be completed, at the intervals prescribed by that section, using the new anniversary date; and
- .3** the expiry date may remain unchanged, provided one or more annual or intermediate surveys, as appropriate, are carried out so that the maximum intervals between the surveys prescribed by 1.4.2 are not exceeded.

1.4.6.9 A certificate issued under 1.4.4 or 1.4.5 shall cease to be valid in any of the following cases:

- .1** if the relevant surveys are not completed within the periods specified in 1.4.2;
- .2** if the certificate is not endorsed in accordance with 1.4.2.3 or 1.4.2.4; and
- .3** upon transfer of the ship to the flag of another State. A new certificate shall only be issued when the Government issuing the new certificate is fully satisfied that the ship is in compliance with the provisions of 1.4.3.1 and 1.4.3.2. In the case of a transfer between Contracting Governments to the SOLAS Convention, if requested within three months after the transfer has taken place, the Government of the State whose flag the ship was formerly entitled to fly shall, as soon as possible, transmit to the Administration copies of the certificate carried by the ship before the transfer and, if available, copies of the relevant survey reports.

1.5 Classification surveys and certification

1.5.1 Assignment of PRS class

1.5.1.1 Conditions for the assignments of PRS class to a newbuilding ship, including scope of initial survey, are detailed in *PKiBSM, Part I, 4.2*.

1.5.1.2 Conditions for the assignments of PRS class to an existing ship, including required technical documentation and scope of initial survey are detailed in *PKiBSM, Part I, 4.3, 4.4 and 4.5*.

1.5.2 Maintenance of PRS class

1.5.2.1 Conditions for the maintenance of PRS class, including scope of periodical surveys (annual, intermediate, renewal) and occasional surveys, are detailed in *PKiBSM, Part I, 5.1 to 5.11*.

1.5.2.2 Additionally gas tankers hull structure and piping systems are subject to the surveys detailed in 1.5.3.

1.5.2.3 Gas tankers cargo installation are subject to the surveys detailed in 1.5.4.

1.5.3 Hull Surveys for Liquefied Gas Carriers

IACS UR Z7.2

1.5.3.1 GENERAL (1.)

1.5.3.1.1 Application(1.1)

1.5.3.1.1.1 The requirements apply to all self-propelled ships carrying liquefied gases in bulk. (1.1.1)

1.5.3.1.1.2 The requirements apply to surveys of hull structure and piping systems, except piping covered by 1.5.4 (UR Z16), in way of pump rooms, compressor rooms, cofferdams, pipe tunnels, void spaces and fuel oil tanks within the cargo area and all ballast tanks.

The requirements are additional to the classification requirements applicable to the remainder of the ship. Refer to *PKiBSM, Part I*, 4.3 to 4.5 and 5.1 to 5.11 (UR Z7).

Refer to 1.5.4 (UR Z16) for periodical surveys of cargo installations on ships carrying liquefied gases in bulk. (1.1.2)

1.5.3.1.1.3 The requirements contain the minimum extent of examination, thickness measurements and tank testing. The survey is to be extended when Substantial Corrosion and/or structural defects are found and include additional Close-up Survey when necessary. (1.1.3)

1.5.3.1.2 Definitions (1.2)

1.5.3.1.2.1 Ballast Tank

A Ballast Tank is a tank that is being used primarily for salt water ballast. (1.2.1)

1.5.3.1.2.2 Overall Survey

An Overall Survey is a survey intended to report on the overall condition of the hull structure and determine the extent of additional Close-up Surveys. (1.2.2)

1.5.3.1.2.3 Close-up Survey

A Close-up Survey is a survey where the details of structural components are within the close visual inspection range of the surveyor, i.e. normally within reach of hand. (1.2.3)

1.5.3.1.2.4 Transverse Section

A Transverse Section includes all longitudinal members such as plating, longitudinals and girders at the deck, sides, bottom, inner bottom and longitudinal bulkheads. (1.2.4)

1.5.3.1.2.5 Representative Tank

Representative Tanks are those which are expected to reflect the condition of other Tanks of similar type and service and with similar corrosion prevention systems. When selecting Representative Tanks account is to be taken of the service and repair history on board and identifiable Critical Structural Areas and/or Suspect Areas. (1.2.5)

1.5.3.1.2.6 Critical Structural Areas

Critical Structural Areas are locations which have been identified from calculations to require monitoring or from the service history of the subject ship or from similar ships or sister ships, if applicable, to be sensitive to cracking, buckling or corrosion which would impair the structural integrity of the ship. (1.2.6)

1.5.3.1.2.7 Suspect Areas

Suspect Areas are locations showing Substantial Corrosion and/or are considered by the surveyor to be prone to rapid wastage. (1.2.7)

1.5.3.1.2.8 Substantial Corrosion

Substantial Corrosion is an extent of corrosion such that assessment of corrosion pattern indicates a wastage in excess of 75% of allowable margins, but within acceptable limits. (1.2.8)

1.5.3.1.2.9 Corrosion Prevention System

A Corrosion Prevention System is normally considered a full hard protective coating. Hard Protective Coating is usually to be epoxy coating or equivalent. Other coating systems, which are neither soft nor semi-hard coatings, may be considered acceptable as alternatives provided that they are applied and maintained in compliance with the manufacturer's specifications. (1.2.9)

1.5.3.1.2.10 Coating Condition

Coating Condition is defined as follows:

GOOD condition with only minor spot rusting.

FAIR condition with local breakdown at edges of stiffeners and weld connections and/or light rusting over 20% or more of areas under consideration, but less than as defined for POOR condition.

POOR condition with general breakdown of coating over 20% or more of areas or hard scale at 10% or more of areas under consideration. (1.2.10)

1.5.3.1.2.11 Cargo Area

Cargo Area is that part of the ship which contains cargo tanks, cargo/ballast pump rooms, compressor rooms, cofferdams, ballast tanks and void spaces adjacent to cargo tanks and also deck areas throughout the entire length and breadth of the part of the ship over the above mentioned spaces. (1.2.11)

1.5.3.1.2.12 Special Consideration

Special Consideration or specially considered (in connection with close-up surveys and thickness measurements) means sufficient close-up inspection and thickness measurements are to be taken to confirm the actual average condition of the structure under the coating. (1.2.12)

1.5.3.1.2.13 Prompt and Thorough Repair

A Prompt and Through Repair is a permanent repair completed at the time of survey to the satisfaction of the surveyor, therein removing the need for the imposition of any associated condition of classification. (1.2.13)

1.5.3.1.2.14 Remote Inspection Techniques (RIT)

Remote Inspection Technique is a means of survey that enables examination of any part of the structure without the need for direct physical access of the surveyor (refer to REC.42 – *PKiBSM Part I*, 5.1.4). (1.2.14)

1.5.3.1.3 Repairs (1.3)

1.5.3.1.3.1 Any damage in association with wastage over the allowable limits (including buckling, grooving, detachment or fracture), or extensive areas of wastage over the allowable limits, which affects or, in the opinion of the Surveyor, will affect the vessel's structural, watertight or weathertight integrity, is to be promptly and thoroughly (see 1.5.3.1.2.13 (1.2.13)) repaired. Areas to be considered include:

- side structure and side plating;
- deck structure and deck plating;
- bottom structure and bottom plating;
- watertight bulkheads;
- items in 3.2.3.5 (weld connection between air pipes and deck plating), 3.2.3.6 (all air pipe heads installed on the exposed decks) and 3.2.3.8 (ventilators, including closing devices) of UR Z7 (see also *PKiBSM, Part I*, 5.1.1.13).

For locations where adequate repair facilities are not available, consideration may be given to allow the vessel to proceed directly to a repair facility. This may require discharging the cargo and/or temporary repairs for the intended voyage. (1.3.1)

1.5.3.1.3.2 Additionally, when a survey results in the identification of structural defects or corrosion, either of which, in the opinion of the surveyor, will impair the vessel's fitness for continued service, remedial measures are to be implemented before the ship continues in service. (1.3.2)

1.5.3.1.3.3 Where the damage found on structure mentioned in 1.5.3.1.3.1 (Para. 1.3.1) is isolated and of a localised nature which does not affect the ship's structural integrity, consideration may be given by the surveyor to allow an appropriate temporary repair to restore watertight or weather tight integrity and impose a condition of class in accordance with IACS PR 35, with a specific time limit. (1.3.3)

1.5.3.1.4 Thickness measurements and close-up surveys (1.4)

1.5.3.1.4.1 In any kind of survey, i.e. special, intermediate, annual or other surveys having the scope of the foregoing ones, thickness measurements, when required by Table II, of structures in areas where close-up surveys are required, shall be carried out simultaneously with close-up surveys. (1.4.1)

1.5.3.1.4.2 Consideration may be given by the attending Surveyor to allow use of Remote Inspection Techniques (RIT) as an alternative to close-up survey. Surveys conducted using a RIT are to be completed to the satisfaction of the attending Surveyor. When RIT is used for a close-up survey, temporary means of access for the corresponding thickness measurements as specified in this UR is to be provided unless such RIT is also able to carry out the required thickness measurements. (1.4.2)

1.5.3.1.5 Remote Inspection Techniques (RIT) (1.5)

1.5.3.1.5.1 The RIT is to provide the information normally obtained from a close-up survey. RIT surveys are to be carried out in accordance with the requirements given here-in and the requirements of *PKiBSM, Part I*, 5.1.4 (IACS Recommendation 42 'Guidelines for Use of Remote Inspection Techniques for Surveys'). These considerations are to be included in the proposals for use of a RIT which are to be submitted in advance of the survey so that satisfactory arrangements can be agreed with the Classification Society. (1.5.1)

1.5.3.1.5.2 The equipment and procedure for observing and reporting the survey using a RIT are to be discussed and agreed with the parties involved prior to the RIT survey, and suitable time is to be allowed to set-up, calibrate and test all equipment beforehand. (1.5.2)

1.5.3.1.5.3 When using a RIT as an alternative to close-up survey, if not carried out by the Society itself, it is to be conducted by a firm approved as a service supplier according to PRS *Publication 51/P – Procedural Requirements for Service Suppliers* (UR Z17) and is to be witnessed by an attending surveyor of the Society. (1.5.3)

1.5.3.1.5.4 The structure to be examined using a RIT is to be sufficiently clean to permit meaningful examination. Visibility is to be sufficient to allow for a meaningful examination. The Classification Society is to be satisfied with the methods of orientation on the structure. (1.5.4)

1.5.3.1.5.5 The Surveyor is to be satisfied with the method of data presentation including pictorial representation, and a good two-way communication between the Surveyor and RIT operator is to be provided. (1.5.5)

1.5.3.1.5.6 If the RIT reveals damage or deterioration that requires attention, the Surveyor may require traditional survey to be undertaken without the use of a RIT. (1.5.6)

1.5.3.2 SPECIAL SURVEY* (2.)

* Some member Societies use the term "Special Periodical Survey" others use the term "Class Renewal Survey" instead of the term "Special Survey". PRS uses the term "Class Renewal Survey".

1.5.3.2.1 Schedule (2.1)

1.5.3.2.1.1 Class Renewal Surveys (Special Surveys) are to be carried out at 5 years intervals to renew the Classification Certificate. (2.1.1)

1.5.3.2.1.2 The first Class Renewal Survey (Special Survey) is to be completed within 5 years from the date of the initial classification survey and thereafter within 5 years from the credited date of the previous Class Renewal Survey (Special Survey). However, an extension of class of 3 months maximum beyond the 5th year can be granted in exceptional circumstances. In this case, the next period of class will start from the expiry date of the Class Renewal Survey (Special Survey) before the extension was granted. (2.1.2)

1.5.3.2.1.3 For surveys completed within 3 months before the expiry date of the Class Renewal Survey (Special Survey), the next period of class will start from the expiry date of the Class Renewal Survey (Special Survey). For surveys completed more than 3 months before the expiry date of the Class Renewal Survey (Special Survey), the period of class will start from the survey completion date. In cases where the vessel has been laid up or has been out of service for a considerable period because of a major repair or modification and the owner elects to only carry out the overdue surveys, the next period of class will start from the expiry date of the Class Renewal Survey (Special Survey). If the owner elects to carry out the next due Class Renewal Survey (Special Survey), the period of class will start from the survey completion date. (2.1.3)

1.5.3.2.1.4 The Class Renewal Survey (Special Survey) may be commenced at the 4th Annual Survey and be progressed with a view to completion by the 5th anniversary date. When the Class Renewal Survey (Special Survey) is commenced prior to the 4th Annual Survey, the entire survey is to be completed within 15 months if such work is to be credited to the Class Renewal Survey (Special Survey). (2.1.4)

1.5.3.2.1.5 A survey planning meeting is to be held prior to the commencement of the survey. (2.1.5)

1.5.3.2.1.6 Concurrent crediting to both Intermediate Survey (IS) and Class Renewal Survey (Special Survey (SS)) for surveys and thickness measurements of spaces are not acceptable. (2.1.6)

1.5.3.2.2 **Scope** (2.2)

1.5.3.2.2.1 **General** (2.2.1)

1.5.3.2.2.1.1 The Class Renewal Survey (Special Survey) is to include, in addition to the requirements of the Annual Surveys, examination, tests and checks of sufficient extent to ensure that the hull and related piping, as required in 2.2.1.3, are in a satisfactory condition and fit for the intended purpose for the new period of class of 5 years to be assigned, subject to proper maintenance and operation and to periodical surveys being carried out at the due dates. (2.2.1.1)

1.5.3.2.2.1.2 Ballast tanks, including double bottom tanks, pump rooms, compressor rooms, pipe tunnels, cofferdams and void spaces bounding cargo tanks, decks and outer hull are to be examined, and this examination is to be supplemented by thickness measurement and testing as required in 2.4 and 2.5, to ensure that the structural integrity remains effective.

The aim of the examination is to discover Substantial Corrosion, significant deformation, fractures, damages or other structural deterioration, that may be present. (2.2.1.2)

1.5.3.2.2.1.3 All piping systems within the above spaces, except those covered by 1.5.4 (UR Z16), are to be examined and operationally tested to working pressure to attending Surveyor's satisfaction to ensure that tightness and condition remain satisfactory. (2.2.1.3)

1.5.3.2.2.1.4 The survey extent of ballast tanks converted to void spaces is to be specially considered in relation to the requirements for ballast tanks. (2.2.1.4)

Note: For survey of automatic air pipes refer to 2.2.13 of UR Z7. (complete examination, both externally and internally, of required number of automatic air pipe heads according to *PKiBSM, Part I*, 5.4.1.2 – 1st hull class renewal survey, 5.4.2.2 – 2nd hull class renewal survey, 5.4.3.2 – 3rd hull class renewal survey).

1.5.3.2.2.2 **Dry Dock Survey** (2.2.2)

1.5.3.2.2.2.1 A survey in dry dock is to be a part of the Class Renewal Survey (Special Survey). The overall and close-up surveys and thickness measurements, as applicable, of the lower portions of the ballast tanks are to be carried out in accordance with the applicable requirements for Class Renewal Surveys (Special Surveys), if not already performed. (2.2.2.1)

Note: Lower portions of the ballast tanks are considered to be the parts below light ballast water line.

1.5.3.2.2.3 **Tank Protection** (2.2.3)

1.5.3.2.2.3.1 Where provided, the condition of corrosion prevention system of ballast tanks is to be examined. For ballast tanks, excluding double bottom tanks, where a hard protective coating is found in POOR condition and it is not renewed, where soft or semi-hard coating has been applied, or where a hard protective coating was not applied from time of construction, the tanks in question are to be examined at annual intervals. Thickness measurements are to be carried out as deemed necessary by the surveyor.

When such breakdown of hard protective coating is found in double bottom ballast tanks and it is not renewed, where a soft or semi-hard coating has been applied, or where a hard protective coating was not applied from the time of construction, the tanks in question may be examined at annual intervals. When considered necessary by the surveyor, or where extensive corrosion exists, thickness measurements are to be carried out. (2.2.3.1)

1.5.3.2.3.2 Where the hard protective coating in ballast tanks is found to be in a GOOD condition, the extent of close-up surveys and thickness measurements may be specially considered. (2.2.3.2)

1.5.3.2.3 Extent of Overall and Close-up Survey (2.3)

1.5.3.2.3.1 An Overall Survey of all tanks and spaces, excluding fuel oil, lube oil and fresh water tanks, is to be carried out at each Class Renewal Survey (Special Survey). (2.3.1)

Note: For fuel oil, lube oil and fresh water tanks, reference is to be made to UR Z7, Table 3. (see *PKiBSM, Part I*, 5.4.2.1 – 2nd hull class renewal survey, 5.4.3.1 – 3rd hull class renewal survey, 5.4.4.1 – 4th hull class renewal survey),

1.5.3.2.3.2 The minimum requirements for close-up surveys at Class Renewal Survey (special survey) are given in Table I. (2.3.2)

1.5.3.2.3.3 The Surveyor may extend the close-up survey as deemed necessary taking into account the maintenance of the tanks under survey, the condition of the corrosion prevention system and where tanks have structural arrangements or details which have suffered defects in similar spaces or on similar ships according to available information. (2.3.3)

1.5.3.2.3.4 For areas in tanks where hard protective coatings are found to be in a GOOD condition, the extent of close-up surveys according to Table I may be specially considered. (2.3.4)

Note: For examination of automatic air pipe heads, reference is to be made to UR Z7, Table 4 (see *PKiBSM, Part I*, 5.4.1.2 – 1st hull class renewal survey, 5.4.2.2 – 2nd hull class renewal survey, 5.4.3.2 – 3rd hull class renewal survey).

1.5.3.2.4 Extent of Thickness Measurement (2.4)

1.5.3.2.4.1 The minimum requirements for thickness measurements at Class Renewal Survey (Special Survey) are given in Table II. (2.4.1)

1.5.3.2.4.2 The Surveyor may extend the thickness measurements as deemed necessary. When thickness measurements indicate substantial corrosion, the extent of thickness measurements is to be increased to determine the extent of areas of substantial corrosion. Table V may be used as guidance for these additional thickness measurements. (2.4.2)

1.5.3.2.4.3 For areas in tanks where hard protective coatings are found to be in a GOOD condition, the extent of thickness measurement according to Table II may be specially considered. (2.4.3)

1.5.3.2.4.4 Transverse sections are to be chosen where the largest reductions are suspected to occur or are revealed from deck plating measurements. (2.4.4)

1.5.3.2.5 Extent of Tank Testing (2.5)

1.5.3.2.5.1 All boundaries of ballast tanks and deep tanks used for water ballast within the cargo area are to be pressure tested. For fuel oil tanks, the representative tanks are to be pressure tested. (2.5.1)

1.5.3.2.5.2 The Surveyor may extend the tank testing as deemed necessary. (2.5.2)

1.5.3.2.5.3 Tank testing of fuel oil tanks is to be carried out with a head of liquid to the highest point that liquid will rise under service conditions. Tank testing of fuel oil tanks may be specially considered based on a satisfactory external examination of the tank boundaries, and a confirmation from the Master stating that the pressure testing has been carried out according to the requirements with satisfactory results. (2.5.3)

1.5.3.3 ANNUAL SURVEY (3.)

1.5.3.3.1 Schedule (3.1)

1.5.3.3.1.1 Annual Surveys are to be held within 3 months before or after anniversary date from the date of the initial classification survey or of the date credited for the last Class Renewal Survey (Special Survey). (3.1.1)

1.5.3.3.2 Scope (3.2)

1.5.3.3.2.1 General (3.2.1)

1.5.3.3.2.1.1 The survey is to consist of an examination for the purpose of ensuring, as far as practicable, that the hull and piping are maintained in a satisfactory condition. (3.2.1.1)

1.5.3.3.2.2 Examination of the hull (3.2.2)

1.5.3.3.2.2.1 Examination of the hull plating and its closing appliances as far as can be seen. (3.2.2.1)

1.5.3.3.2.2.2 Examination of watertight penetrations as far as practicable. (3.2.2.2)

1.5.3.3.2.3 Examination of weather decks (3.2.3)

1.5.3.3.2.3.1 Examination of flame screens on vents to all bunker tanks. (3.2.3.1)

1.5.3.3.2.3.2 Examination of bunker and vent piping systems. (3.2.3.2)

1.5.3.3.2.4 Examination of cargo pump rooms and compressor rooms and, as far as practicable, pipe tunnels if fitted. (3.2.4)

1.5.3.3.2.4.1 Examination of all pump room and compressor room bulkheads for signs of leakage or fractures and, in particular, the sealing arrangements of all penetrations of pump room and compressor room bulkheads. (3.2.4.1)

1.5.3.3.2.4.2 Examination of the condition of all piping systems, except those covered by 1.5.4 (UR Z16). (3.2.4.2)

Note: For survey of air pipes, flame screens on vents and ventilators refer to 3.2.3.5 to 3.2.3.8 of UR Z7 (3.2.3.5 – weld connection between air pipes and deck plating, 3.2.3.6 – air pipe heads installed on the exposed decks, 3.2.3.7 – flame screens on vents to all bunker tanks and 3.2.3.8 – ventilators, including closing devices).

1.5.3.3.2.5 Suspect Areas

Suspect Areas identified at previous surveys are to be examined. Thickness measurements are to be taken of the areas of substantial corrosion and the extent of thickness measurements is to be increased to determine the extent of areas of substantial corrosion. Table V may be used as guidance for these additional thickness measurements. These extended thickness measurements are to be carried out before the annual survey is credited as completed. (3.2.5)

1.5.3.3.2.6 Examination of ballast tanks (3.2.6)

1.5.3.3.2.6.1 Examination of ballast tanks when required as a consequence of the results of the Class Renewal Survey (Special Survey) and Intermediate Survey is to be carried out. When considered necessary by the surveyor, or where extensive corrosion exists, thickness measurement is to be carried out. If the results of these thickness measurements indicate that Substantial Corrosion is found, then the extent of thickness measurements are to be increased to determine the extent of areas of substantial corrosion. Table V may be used as guidance for these additional measurements. These extended thickness measurements are to be carried out before the annual survey is credited as completed. (3.2.6.1)

1.5.3.4 INTERMEDIATE SURVEY (4.)

1.5.3.4.1 Schedule (4.1)

1.5.3.4.1.1 The Intermediate Survey is to be held at or between either the 2nd or 3rd Annual Survey. (4.1.1)

1.5.3.4.1.2 Those items which are additional to the requirements of the Annual Surveys may be surveyed either at or between the 2nd and 3rd Annual Survey. (4.1.2)

1.5.3.4.1.3 A survey planning meeting is to be held prior to the commencement of the survey. (4.1.3)

1.5.3.4.1.4 Concurrent crediting to both Intermediate Survey (IS) and Class Renewal Survey (Special Survey (SS)) for surveys and thickness measurements of spaces are not acceptable. (4.1.4)

1.5.3.4.2 Scope (4.2)

1.5.3.4.2.1 The scope of the second or third annual survey is to be extended to include the following: (4.2.1)

1.5.3.4.2.2 Ballast tanks (4.2.2)

1.5.3.4.2.2.1 For ships between 5 and 10 years of age, an overall survey of representative ballast tanks is to be carried out. If there is no hard protective coating, soft or semi-hard coating or POOR coating condition, the examination is to be extended to other ballast tanks of the same type. (4.2.2.1)

1.5.3.4.2.2.2 For ships over 10 years of age, an overall survey of all ballast tanks is to be carried out. (4.2.2.2)

1.5.3.4.2.2.3 If such examinations reveal no visible structural defects, the examination may be limited to a verification that the corrosion prevention system remains efficient. (4.2.2.3)

1.5.3.4.2.2.4 For ballast tanks, excluding double bottom tanks, if there is no hard protective coating, soft or semi-hard coating, or POOR coating condition and it is not renewed, the tanks in question are to be internally examined at annual intervals. (4.2.2.4)

1.5.3.4.2.2.5 When such conditions are found in double bottom ballast tanks, the tanks in question may be internally examined at annual intervals. (4.2.2.5)

1.5.3.4.2.2.6 The minimum requirements for close-up surveys at intermediate survey are given in Table III. (4.2.2.6)

1.5.3.5 PREPARATION FOR SURVEY (5.)**1.5.3.5.1 Conditions of Survey (5.1)**

1.5.3.5.1.1 The Owner is to provide the necessary facilities for a safe execution of the survey. (5.1.1)

1.5.3.5.1.2 Tanks and Spaces are to be safe for access, i.e. gas freed, ventilated and illuminated. (5.1.2)

1.5.3.5.1.3 In preparation for survey and thickness measurements and to allow for a thorough examination, all spaces are to be cleaned including removal from surfaces of all loose accumulated corrosion scale. Spaces are to be sufficiently clean and free from water, scale, dirt, oil residues etc. to reveal corrosion, deformation, fractures, damages, or other structural deterioration. However, those areas of structure whose renewal has already been decided by the owner need only be cleaned and descaled to the extent necessary to determine the limits of the areas to be renewed. (5.1.3)

1.5.3.5.1.4 Sufficient illumination is to be provided to reveal corrosion, deformation, fractures, damages or other structural deterioration. (5.1.4)

1.5.3.5.1.5 Where soft or semi-hard coatings have been applied, safe access is to be provided for the surveyor to verify the effectiveness of the coating and to carry out an assessment of the conditions of internal structures which may include spot removal of the coating. When safe access cannot be provided, the soft or semi-hard coating is to be removed. (5.1.5)

1.5.3.5.2 Access to Structures (5.2)

1.5.3.5.2.1 For Overall Survey, means are to be provided to enable the surveyor to examine the hull structure in a safe and practical way. (5.2.1)

1.5.3.5.2.2 For Close-up Surveys, one or more of the following means for access, acceptable to the Surveyor, is to be provided:

- permanent staging and passages through structures;
- temporary staging, e.g. ladders, and passages through structures;
- other equivalent means. (5.2.2)

1.5.3.5.2.3 For Surveys conducted by use of a remote inspection technique, one or more of the following means for access, acceptable to the Surveyor, is to be provided:

- Unmanned robot arm.
- Remotely Operated Vehicles (ROV).
- Unmanned Aerial Vehicles / Drones.
- Other means acceptable to the Classification Society. (5.2.3)

1.5.3.5.3 Equipment for Survey (5.3)

1.5.3.5.3.1 Thickness measurement is normally to be carried out by means of ultrasonic test equipment. The accuracy of the equipment is to be proven to the Surveyor as required. (5.3.1)

1.5.3.5.3.2 One or more of the following fracture detection procedures may be required if deemed necessary by the Surveyor:

- radiographic equipment
- ultrasonic equipment
- magnetic particle equipment
- dye penetrant (5.3.2)

1.5.3.5.4 Survey at Sea or at Anchorage (5.4)

1.5.3.5.4.1 Survey at sea or at anchorage may be accepted provided the Surveyor is given the necessary assistance from the personnel on board. Necessary precautions and procedures for carrying out the survey are to be in accordance with 1.5.3.5.1, 1.5.3.5.2 and 1.5.3.5.3 (5.1, 5.2, and 5.3). (5.4.1)

1.5.3.5.4.2 A communication system is to be arranged between the survey party in the tank and the responsible officer on deck. (5.4.2)

1.5.3.6 PROCEDURES FOR THICKNESS MEASUREMENTS (6.)

1.5.3.6.1 General (6.1)

1.5.3.6.1.1 The required thickness measurements, if not carried out by the Society itself, are to be witnessed by a Surveyor of the Society. The Surveyor is to be on board to the extent necessary to control the process. (6.1.1)

1.5.3.6.1.2 The thickness measurement company is to be part of the survey planning meeting to be held prior to commencing the survey. (6.1.2)

1.5.3.6.1.3 Thickness measurements of structures in areas where close-up surveys are required shall be carried out simultaneously with close-up surveys. (6.1.3)

1.5.3.6.2 Certification of Thickness Measurement Company (6.2)

1.5.3.6.2.1 The thickness measurements are to be carried out by a company certified by the Classification Society according to principles stated in Table IV, except that in respect of measurements of ships less than 500 gross tonnage, the firm need not be so approved. (6.2.1)

1.5.3.6.3 Reporting (6.3)

1.5.3.6.3.1 A thickness measurement report is to be prepared. The report is to give the location of measurements, the thickness measured as well as corresponding original thickness. Furthermore, the report is to give the date when the measurements were carried out, type of measurement equipment, names of personnel and their qualifications and has to be signed by the operator. (6.3.1)

1.5.3.6.3.2 The Surveyor is to review the final thickness measurement report and countersign the cover page. (6.3.2)

TABLE I
TABLE OF THE MINIMUM REQUIREMENTS FOR CLOSE-UP SURVEY AT HULL CLASS
RENEWAL SURVEYS (SPECIAL SURVEYS) OF LIQUEFIED GAS CARRIERS

Class Renewal Survey No. 1 (Special Survey No. 1) (age ≤ 5)	Class Renewal Survey No. 2 (Special Survey No. 2) (5 < age ≤ 10)	Class Renewal Survey No. 3 and subsequent (Special Survey No. 3 and subsequent) (age > 10)
One web frame in a representative ballast tank of the topside, hopper side and double hull side type (1) One transverse bulkhead in a ballast tank (3)	All web frames in a ballast tank, which is to be a double hull side tank or a topside tank. If such tanks are not fitted, another ballast tank is to be selected (1) One web frame in each remaining ballast tank (1) One transverse bulkhead in each ballast tank (2)	All web frames in all ballast tanks (1) All transverse bulkheads in all ballast tanks (2)

(1) Complete transverse web frame including adjacent structural members.
 (2) Transverse bulkhead complete, including girder system and adjacent members, and adjacent longitudinal bulkhead structure.
 (3) Transverse bulkhead lower part including girder system and adjacent structural members.

Note 1: Ballast tanks include topside, double hull side, double bottom, hopper side, or any combined arrangement of the aforementioned, and peak tanks where fitted.

Note 2: For areas in tanks where coatings are found to be in GOOD condition, as defined in 1.5.3.1.2.10 (1.2.10), the extent of close-up surveys may be specially considered by the Classification Society.

Note 3: For ships having independent tanks of type C, with a midship section similar to that of a general cargo ship, the extent of close-up surveys may be specially considered by the Classification Society.

Note 4: The Surveyor may extend the close-up survey as deemed necessary, taking into account the maintenance of the tanks under survey, the condition of the corrosion prevention system and also in the following cases:

- in particular, in tanks having structural arrangements or details which have suffered defects in similar tanks, or on similar ships according to available information;
- in tanks having structures approved with reduced scantlings.

TABLE II

TABLE OF MINIMUM REQUIREMENTS FOR THE THICKNESS MEASUREMENT AT HULL CLASS RENEWAL SURVEY (SPECIAL SURVEY) OF LIQUEFIED GAS CARRIERS

Class Renewal Survey (Special Survey) No. 1 age ≤ 5	Class Renewal Survey (Special Survey) No. 2 5 < age ≤ 10	Class Renewal Survey (Special Survey) No. 3 10 < age ≤ 15	Class Renewal Survey (Special Survey) No. 4 age > 15
One section of deck plating for the full beam of the ship within 0.5 L amidships in way of a ballast tank, if any	Within the cargo area: – each deck plate – one transverse section within 0.5 L amidships in way of a ballast tank, if any	Within the cargo area: – each deck plate – two transverse sections (1) – all wind and water strakes	Within the cargo area: – each deck plate – three transverse sections (1) – each bottom plate – duct keel plating and internals
	Selected wind and water strakes outside the cargo area	Selected wind and water strakes outside the cargo area	All wind and water strakes, full length
Measurements, for general assessment and recording of corrosion pattern, of those structural members subject to Close-up Survey according to Table I	Measurements, for general assessment and recording of corrosion pattern, of those structural members subject to Close-up Survey according to Table I	Measurements, for general assessment and recording of corrosion pattern, of those structural members subject to Close-up Survey according to Table I	Measurements, for general assessment and recording of corrosion pattern, of those structural members subject to Close-up Survey according to Table I
Suspect areas	Suspect areas	Suspect areas	Suspect areas
(1) at least one section is to include a ballast tank within 0,5 L amidships, if any Note 1: For ships having independent tanks of type C, with a midship section similar to that of a general cargo ship, the extent of thickness measurements may be increased to include the tank top plating at the discretion of the Surveyor. Note 2: For areas in spaces where coatings are found to be in GOOD condition, as defined in 1.5.3.1.2.10 (1.2.10), the extent of thickness measurements may be specially considered by the Classification Society. Note 3: The Surveyor may extend the thickness measurements as deemed necessary. Where substantial corrosion, as defined in 1.5.3.1.2.8 (1.2.8), is found, the extent of thickness measurements is to be increased to the satisfaction of the Surveyor.			

TABLE III
TABLE OF MINIMUM REQUIREMENTS FOR CLOSE-UP SURVEY AT HULL INTERMEDIATE SURVEYS OF LIQUEFIED GAS CARRIERS

10 < age ≤ 15	age > 15
Close-up survey of: <ul style="list-style-type: none"> – all web frames and both transverse bulkheads in a representative ballast tank (1) and (2) – the upper part of one web frame in another representative ballast tank – one transverse bulkhead in another representative ballast tank (2) 	Close-up survey of: <ul style="list-style-type: none"> – all web frames and both transverse bulkheads in two representative ballast tanks (1) and (2)
(1) Complete transverse web frame including adjacent structural members (2) Transverse bulkhead complete, including girder system and adjacent members, and adjacent longitudinal bulkhead structure Note 1: Ballast tanks include topside, double hull side, double bottom, hopper side, or any combined arrangement of the aforementioned, and peak tanks where fitted. Note 2: For areas in tanks where protective coating is found to be in GOOD condition, the extent of close-up survey may be specially considered by the Classification Society. Note 3: For ships having independent tanks of type C, with a midship section similar to that of a general cargo ship, the extent of close-up surveys may be specially considered by the Classification Society. Note 4: The extent of close-up surveys may be extended by the Surveyor as deemed necessary, taking into account the maintenance of the tanks under survey, the condition of the corrosion prevention system and also in the following cases: <ul style="list-style-type: none"> – in particular, in tanks having structural arrangements or details which have suffered defects in similar tanks, or on similar ships according to available information; – in tanks having structures approved with reduced scantlings. 	

TABLE IV
PROCEDURES FOR CERTIFICATION OF FIRMS ENGAGED IN THICKNESS MEASUREMENT OF HULL STRUCTURES

1. Application

This guidance applies for certification of the firms which intend to engage in the thickness measurement of hull structures of the vessels. PRS *Publication 51/P – Procedural Requirements for Service Suppliers* (UR Z17) also applies.

2. Procedures for Certification

- (1) Submission of Documents: Following documents are to be submitted to the Society for approval:
- a) Outline of firm, e.g. organization and management structure.
 - b) Experience of the firm on thickness measurement inter alia of hull structures of the vessels.
 - c) Technicians' careers, i.e. experience of technicians as thickness measurement operators, technical knowledge of hull structure, etc. Operators, are to be qualified according to a recognized industrial NDT Standard.
 - d) Equipment used for thickness measurement such as ultra-sonic testing machines and its maintenance/calibration procedures.
 - e) A guide for thickness measurement operators.
 - f) Training programmes of technicians for thickness measurement.

(2) Auditing of the firms:

Upon reviewing the documents submitted with satisfactory results, the firm is audited in order to ascertain that the firm is duly organised and managed in accordance with the documents submitted, and eventually is capable of conducting thickness measurement of the hull construction of the ships.

(3) Certification is conditional on an onboard demonstration at thickness measurements as well as satisfactory reporting.**3. Certification**

(1) Upon satisfactory results of both the audit of the firm in 2(2) and the demonstration tests in 2(3) above, the Society will issue a Certificate of Approval as well as a notice to the effect that the thickness measurement operation system of the firm has been certified by the Society.

(2) Renewal/endorsement of the Certificate is to be made at intervals not exceeding 3 years by verification that original conditions are maintained.

4. Information of any alteration to the Certified Thickness Measurement Operation System

In case where any alteration to the certified thickness measurement operation system of the firm is made, such an alteration is to be immediately informed to the Society. Re-audit is made where deemed necessary by the Society.

5. Cancellation of Approval

Approval may be cancelled in the following cases:

(1) Where the measurements were improperly carried out or the results were improperly reported.

(2) Where the Society's surveyor found any deficiencies in the approved thickness measurement operation system of the firm.

(3) Where the firm failed to inform of any alteration in 4 above to the Society.

TABLE V**GUIDANCE FOR ADDITIONAL THICKNESS MEASUREMENTS IN WAY OF SUBSTANTIAL CORROSION**

Structural member	Extent of Measurement	Extent of Measurement
Plating	Suspect area and adjacent plates	5 point pattern over 1 square metre
Stiffeners	Suspect area	3 measurements each in line across web and flange

FIGURE 1
TYPICAL MIDSHIP SECTIONS OF LIQUEFIED GAS CARRIERS

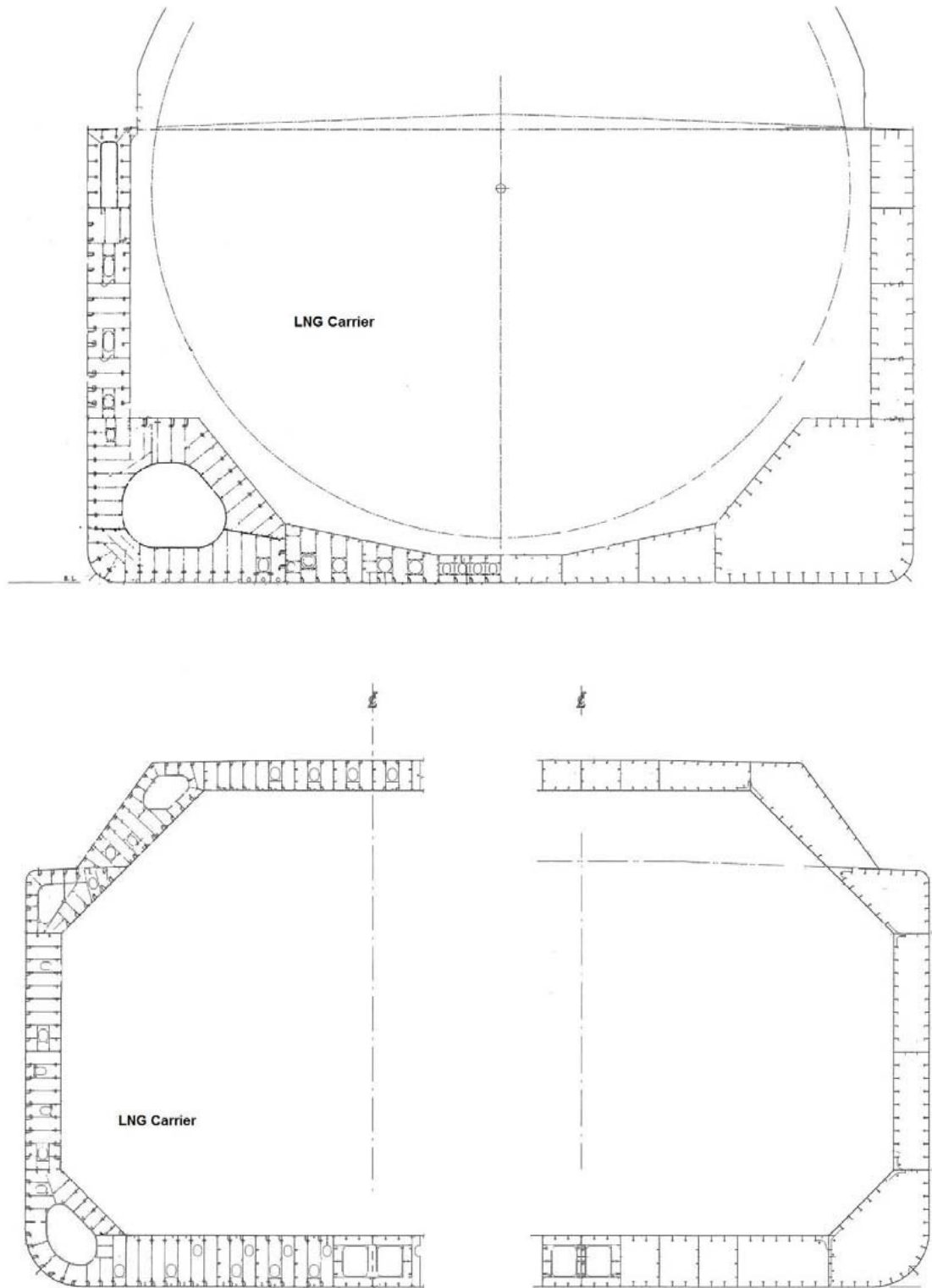

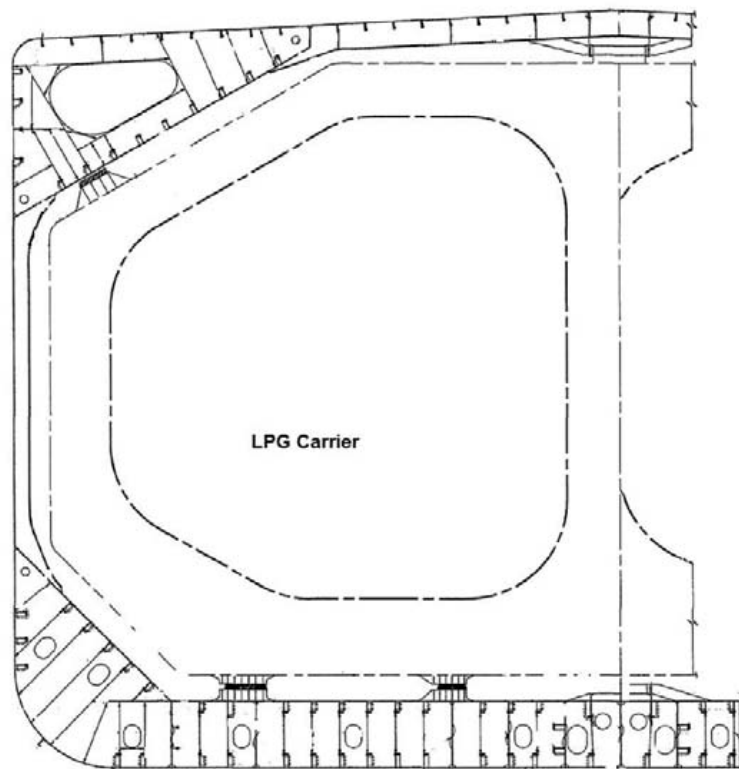
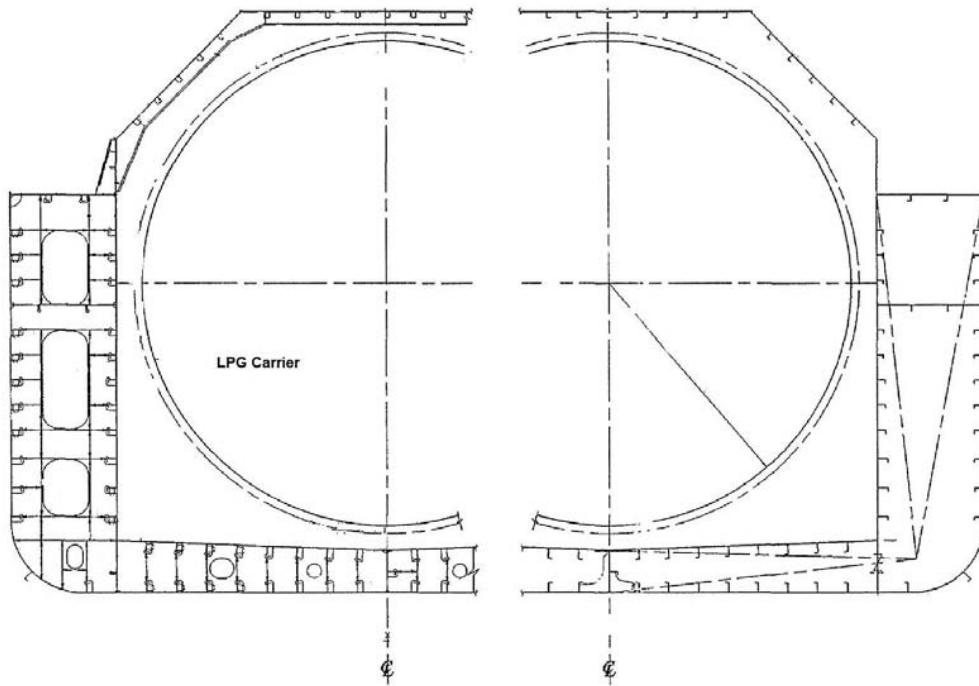

END OF IACS UR Z7.2

1.5.4 Periodical surveys of cargo installations on ships carrying liquefied gases in bulk

IACS UR Z16

1.5.4.1 General (1.)

1.5.4.1.1 Scope

The Surveys required herein are relevant to ships designed for the carriage of liquefied gases in bulk. These requirements are related to cargo installations and are additional to those already specified in *PKiBSM, Part I (Z1 and Z7)*. (1.1)

1.5.4.1.2 Extent and methods (1.2)

1.5.4.1.2.1 The surveys are intended to include all installations and equipment related to the carriage and handling of liquefied gases. These survey requirements do not cover fire protection, fire fighting installation, portable equipment, and personnel protection equipment. (1.2.1)

1.5.4.1.2.2 The annual survey is preferably to be carried out during a loading or discharging operation. Access for cargo tanks or inerted hold spaces, necessitating gas-freeing/aerating will normally not be necessary unless required by the Rules of the individual Society. (1.2.2)

1.5.4.1.2.3 The intermediate survey required in Section 1.5.4.4 (Z16.4), intends to supplement the annual survey by testing cargo handling installations with related automatic control, alarm and safety systems for correct functioning. The intermediate survey is preferably to be carried out with the ship in a gas-free condition. The extent of the testing required for the intermediate survey will normally be such that the survey cannot be carried out during a loading or discharging operation. (1.2.3)

1.5.4.1.3 Survey intervals (1.3)

Survey intervals are to be in accordance with *PKiBSM, Part I (UR Z1 and Z7)*.

1.5.4.2 Class Renewal Survey (Special Survey) (2.)

1.5.4.2.1 General (2.1)

The requirements of Section 1.5.4.4 (Z16.4) apply with the following additions.

1.5.4.2.2 Cargo containment survey (2.2)

1.5.4.2.2.1 All cargo tanks are to be examined internally. (2.2.1)

1.5.4.2.2.2 Special attention is to be given to the cargo tank and insulation in way of chocks, supports and keys. Removal of insulation may be required in order to verify the condition of the tank or the insulation itself if found necessary by the Surveyor.

Where the arrangement is such that the insulation cannot be examined, the surrounding structures of wing tanks, double bottom tanks and cofferdams are to be examined for cold spots when the cargo tanks are in the cold condition unless voyage records together with the instrumentation give sufficient evidence of the integrity of the insulation system. (2.2.2)

1.5.4.2.2.3 Non-destructive testing: (2.2.3)

1.5.4.2.2.3.1 Non-destructive testing is to supplement cargo tank inspection with special attention to be given to the integrity of the main structural members, tank shell and highly stressed parts, including welded connections as deemed necessary by the surveyor. However, for

type C tanks, this does not mean that non-destructive testing can be dispensed with totally. The following items are, inter alia, considered as highly stressed parts:

- cargo tanks supports and anti-rolling/anti-pitching devices,
- web frames or stiffening rings,
- swash bulkhead boundaries,
- dome and stump connections to tank shell,
- foundations for pumps, towers, ladders, etc.,
- pipe connections. (2.2.3.1)

1.5.4.2.2.3.2 For independent tanks type B, the extent of non-destructive testing shall be as given in a programme specially prepared for the cargo tank design. (2.2.3.2)

1.5.4.2.2.4 The tightness of all cargo tanks is to be verified by an appropriate procedure. Provided that the effectiveness of the ship's gas detection equipment has been confirmed, it will be acceptable to utilize this equipment for the tightness test of independent tanks below deck. (2.2.4)

1.5.4.2.2.5 Where findings of 1.5.4.2.2.1 to 1.5.4.2.2.4 (Z16.2.2.1 to Z16.2.2.4) or an examination of the voyage records raises doubts as to the structural integrity of a cargo tank, a hydraulic or hydro-pneumatic test is to be carried out. For integral tanks and for independent tanks type A and B, the test pressure is to be in accordance with IACS UR G1.10.5 which reads:

G1.10.5 Integral tanks are to be hydrostatically or hydropneumatically tested in accordance with the Rules of the Classification Society. The test is in general to be performed so that the stresses approximate, as far as practicable, the design stresses and so that the pressure at the top of the tank corresponds at least to the MARVS.

or G1.10.7 which reads:

G1.10.7 Each independent tank is to be subjected to a hydrostatic or hydropneumatic test. For tanks type A, this test is to be performed so that the stresses approximate, as far as practicable, the design stresses and so that the pressure at the top of the tank corresponds at least to the MARVS. When the hydropneumatic test is performed, the conditions are to simulate, as far as possible, the actual loading of the tank and of its supports. For tanks type B, the test is to be performed as for tanks type A. Moreover, the maximum primary membrane stress or maximum bending stress in a primary membrane under test conditions is not to exceed 90% of the yield strength of the material (as fabricated) at the test temperature. To ensure that this condition is satisfied, when calculations indicate that stress exceeds 75% of the yield strength, the prototype test is to be monitored by the use of strain gauges or other suitable equipment. For tanks type C, see 4.23.8 (G2).

as appropriate. For independent tanks type C, the test pressure is not to be less than 1.25 times the MARVS. (2.2.5)

1.5.4.2.2.6 At every other Class Renewal Survey (special survey) (i.e., 2nd, 4th, 6th, etc.), all independent cargo tanks type C are to be either: (2.2.6)

1.5.4.2.2.6.1 Hydraulically or hydro-pneumatically tested to 1.25 times MARVS, followed by non-destructive testing in accordance with 1.5.4.2.2.3.1 (Z16.2.2.3.1), or (2.2.6.1)

1.5.4.2.2.6.2 Subjected to a thorough, planned non-destructive testing. This testing is to be carried out in accordance with a programme specially prepared for the tank design. If a special programme does not exist, the following applies:

- cargo tank supports and anti-rolling/anti-pitching devices,

- stiffening rings,
- Y-connections between tank shell and a longitudinal bulkhead of bilobe tanks,
- swash bulkhead boundaries,
- dome and sump connections to the tank shell,
- foundations for pumps, towers, ladders etc.,
- pipe connections.

At least 10% of the length of the welded connections in each of the above mentioned areas is to be tested. This testing is to be carried out internally and externally as applicable.

Insulation is to be removed as necessary for the required non-destructive testing. (The individual Societies may choose to include any one or both of the above listed two alternatives in their Rules. PRS accepts both alternatives i.e. 1.5.4.2.2.6.1 and 1.5.4.2.2.6.2.) (2.2.6.2)

1.5.4.2.2.7 As far as practicable all hold spaces and hull insulation (if provided), secondary barriers and tank supporting structures are to be visually examined. The secondary barrier of all tanks is to be checked for their effectiveness by means of a pressure/vacuum test, a visual examination or another acceptable method. (2.2.7)

1.5.4.2.2.8 Inspection/testing of tanks systems/containment systems

- 1) For membrane and semi-membrane tanks systems, inspection and testing are to be carried out in accordance with programmes specially prepared in accordance with an approved method for the actual tank system.
- 2) For membrane containment systems a tightness test of the primary and secondary barrier shall be carried out in accordance with the system designers' procedures and acceptance criteria as approved by the classification society. Low differential pressure tests may be used for monitoring the cargo containment system performance, but are not considered an acceptable test for the tightness of the secondary barrier.
- 3) For membrane containment systems with glued secondary barriers if the designer's threshold values are exceeded, an investigation is to be carried out and additional testing such as thermographic or acoustic emissions testing should be carried out. (2.2.8)

1.5.4.2.2.9 The pressure/vacuum relief valves, rupture disc and other pressure relief devices for interbarrier spaces and hold spaces are to be opened, examined, tested and readjusted as necessary, depending on their design. (2.2.9)

1.5.4.2.2.10 The pressure relief valves for the cargo tanks are to be opened for examination, adjusted, function tested, and sealed. If the cargo tanks are equipped with relief valves with non-metallic membranes in the main or pilot valves, such non-metallic membranes are to be replaced. Where a proper record of continuous overhaul and retesting of individually identifiable relief valves is maintained, consideration will be given to acceptance on the basis of opening, internal examination, and testing of a representative sampling of valves, including each size and type of liquefied gas or vapor relief valve in use, provided there is logbook evidence that the remaining valves have been overhauled and tested since crediting of the previous Class Renewal Survey (Special Survey). (2.2.10)

1.5.4.2.3 Piping systems (2.3)

1.5.4.2.3.1 The cargo, liquid nitrogen and process piping systems, including valves, actuators, compensators, etc. are to be opened for examination as deemed necessary. Insulation is to be removed as deemed necessary to ascertain the condition of the pipes. If the visual examination

raises doubt as to the integrity of the pipelines, a pressure test at 1.25 times the MARVS for the pipeline is to be carried out. After re-assembly the complete piping systems are to be tested for leaks. (2.3.1)

1.5.4.2.3.2 The pressure relief valves are to be function-tested. A random selection of valves is to be opened for examination and adjusted. (2.3.2)

1.5.4.2.4 Components

Cargo pumps, compressors, process pressure vessels, liquid nitrogen tanks, heat exchangers and other components, including prime movers, used in connection with cargo handling and methane boil-off burning are to be examined as required in the Rules of each individual Society for periodical survey of machinery. (2.4)

Note:

For cargo pumps prototype and unit production testing – see 5.14.6.3.1 and 5.14.6.3.2.

1.5.4.2.5 Miscellaneous (2.5)

1.5.4.2.5.1 Systems for removal of water or cargo from interbarrier spaces and holds are to be examined and tested as deemed necessary. (2.5.1)

1.5.4.2.5.2 All gas-tight bulkheads are to be inspected. The effectiveness of gas-tight shaft sealing is to be verified. (2.5.2)

1.5.4.2.5.3 The following equipment is to be examined: hoses and spool pieces used for segregation of piping systems for cargo, inert gas and bilging. (2.5.3)

1.5.4.2.5.4 It is to be verified that all cargo piping systems are electrically bonded to the hull. (2.5.4)

1.5.4.3 Annual Survey (3.)

1.5.4.3.1 General (3.1)

1.5.4.3.1.1 The log books are to be examined with regard to correct functioning of the cargo containment and cargo handling systems. The hours per day of the reliquification plants or the boil-off rate is to be considered. (3.1.1)

1.5.4.3.1.2 All accessible gas-tight bulkhead penetrations including gas-tight shaft sealings are to be visually examined. (3.1.2)

1.5.4.3.1.3 The means for accomplishing gas tightness of the wheelhouse doors and windows is to be examined. All windows and sidescuttles within the area required to be of the fixed type (non-opening) are to be examined for gas tightness. The closing devices for all air intakes and openings into accommodation spaces, service spaces, machinery spaces, control stations and approved openings in superstructures and deckhouses facing the cargo area or bow and stern loading/unloading arrangements, are to be examined. (3.1.3)

1.5.4.3.2 Cargo handling systems (3.2)

The cargo handling piping and machinery, e.g. cargo and process piping, cargo heat exchangers, vapourizers, pumps, compressors and cargo hoses are in general to be visually examined, as far as possible, during operation.

1.5.4.3.3 Cargo containment venting systems (3.3)

Venting systems, including protection screens if provided, for the cargo tanks, interbarrier spaces and hold spaces are to be visually examined externally. It is to be verified that the cargo tank relief valves are sealed and that the certificate for the relief valves opening/closing pressures is onboard.

1.5.4.3.4 Instrumentation and safety systems (3.4)

1.5.4.3.4.1 The instrumentation of the cargo installations with regard to pressure, temperature and liquid level is to be verified in good working order by one or more of the following methods:

- Visual external examination;
- Comparing of read outs from different indicators;
- Consideration of read outs with regard to the actual cargo and/or actual conditions;
- Examination of maintenance records with reference to cargo plant instrumentation maintenance manual;
- Verification of calibration status of the measuring instruments. (3.4.1)

1.5.4.3.4.2 The logbooks are to be examined for confirmation that the emergency shutdown system has been tested. (3.4.2)

1.5.4.3.5 Environmental control for cargo containment systems

- 1) Inert gas/dry air installations including the means for prevention of backflow of cargo vapour to gas-safe spaces are to be verified as being in satisfactory operating condition.
- 2) For membrane containment systems normal operation of the nitrogen control system for insulation and interbarrier spaces shall be confirmed to the Surveyor by the Master. (3.5)

1.5.4.3.6 Miscellaneous (3.6)

1.5.4.3.6.1 It is to be verified that all accessible cargo piping systems are electrically bonded to the hull. (3.6.1)

1.5.4.3.6.2 Arrangements for burning methane boil-off are to be visually examined as far as practicable. The instrumentation and safety systems are to be verified as being in good working order in accordance with 1.5.4.3.4.1 (Z16.3.4.1). (3.6.2)

1.5.4.3.6.3 The relevant instruction and information material such as cargo handling plans, filling limit information, cooling down procedures, etc. are to be verified as being onboard. (3.6.3)

1.5.4.3.6.4 Mechanical ventilation fans in gas dangerous spaces and zones are to be visually examined. (3.6.4)

1.5.4.4 Intermediate survey (4.)

1.5.4.4.1 General

The requirements of Section 1.5.4.3 (Z16.3) apply with the following additions: (4.1)

1.5.4.4.2 Instrumentation and safety systems (4.2)

1.5.4.4.2.1 The instrumentation of the cargo installation with regard to pressure, temperature and liquid level is to be visually examined and to be tested by changing the pressure, temperature and level as applicable and comparing with test instruments. Simulated testing may be accepted for sensors which are not accessible or for sensors located within cargo tanks or inerted hold spaces. The testing is to include testing of alarm and safety functions. (4.2.1)

1.5.4.4.2.2 The piping of the gas detection system is to be visually inspected for corrosion and damage as far as practicable. The integrity of the suction lines between suction points and analyzing units is to be verified as far as possible. Gas Detectors are to be calibrated or verified with sample gases. (4.2.2)

1.5.4.4.2.3 The emergency shutdown system is to be tested, without flow in the pipe lines, to verify that the system will cause the cargo pumps and compressors to stop. (4.2.3)

1.5.4.4.3 Electrical equipment

Electrical equipment in gas-dangerous spaces and zones is to be examined as far as practicable with particular respect to the following:

- Protective earthing (Spot check).
- Integrity of enclosures.
- Damage of outer sheath of cables.
- Function testing of pressurized equipment and of associated alarms.
- Testing of systems for de-energizing non-certified safe electrical equipment located in spaces protected by air-locks, such as electrical motor-rooms, cargo control rooms, etc.
- Testing of insulation resistance of circuits. Such measurements are only to be made when the ship is in a gas-free or inerted condition. Where proper records of testing are maintained consideration may be given to accepting recent readings by the ship's crew. (4.3)

Note: See also PRS Publication 5/1 – Guidelines for the performance of periodical classification surveys of electrical explosion-proof equipment onboard ships in operation other than tankers and on tankers (IACS REC. No.120 Survey of electrical equipment installed in hazardous areas on tankers.)

1.5.4.4.4 Miscellaneous

The instrumentation and safety systems for burning cargo as fuel are to be examined in accordance with the requirements of 1.5.4.4.2.1 (Z16.4.2.1). (4.4)

END OF IACS UR Z16

CHAPTER 2

(IGC Code Chapter 2)

Goal

To ensure that the cargo tanks are in a protective location in the event of minor hull damage, and that the ship can survive the assumed flooding conditions.

2 SHIP SURVIVAL CAPABILITY AND LOCATION OF CARGO TANKS

2.1 General

2.1.1 Ships subject to these *Rules* (the Code) shall survive the hydrostatic effects of flooding following assumed hull damage caused by some external force. In addition, to safeguard the ship and the environment, the cargo tanks shall be protected from penetration in the case of minor damage to the ship resulting, for example, from contact with a jetty or tug, and also given a measure of protection from damage in the case of collision or grounding, by locating them at specified minimum distances inboard from the ship's shell plating. Both the damage to be assumed and the proximity of the tanks to the ship's shell shall be dependent upon the degree of hazard presented by the product to be carried. In addition, the proximity of the cargo tanks to the ship's shell shall be dependent upon the volume of the cargo tank.

2.1.2 Ships subject to these *Rules* (the Code) shall be designed to one of the following standards:

- .1** A **type 1G ship** is a gas carrier intended to transport the products indicated in Chapter 19 that require maximum preventive measures to preclude their escape.
- .2** A **type 2G ship** is a gas carrier intended to transport the products indicated in Chapter 19, that require significant preventive measures to preclude their escape.
- .3** A **type 2PG ship** is a gas carrier of 150 m in length or less intended to transport the products indicated in Chapter 19 that require significant preventive measures to preclude their escape, and where the products are carried in type C independent tanks designed (see 4.23) for a MARVS of at least 0.7 MPa gauge and a cargo containment system design temperature of -55°C or above. A ship of this description that is over 150 m in length is to be considered a type 2G ship.
- .4** A **type 3G ship** is a gas carrier intended to carry the products indicated in Chapter 19 that require moderate preventive measures to preclude their escape.
- .5** Therefore, a type 1G ship is a gas carrier intended for the transportation of products considered to present the greatest overall hazard and types 2G/2PG and type 3G for products of progressively lesser hazards. Accordingly, a type 1G ship shall survive the most severe standard of damage and its cargo tanks shall be located at the maximum prescribed distance inboard from the shell plating.

2.1.3 The ship type required for individual products is indicated in column "c" in the table of Chapter 19.

2.1.4 If a ship is intended to carry more than one of the products listed in Chapter 19, the standard of damage shall correspond to the product having the most stringent ship type requirements. The requirements for the location of individual cargo tanks, however, are those for ship types related to the respective products intended to be carried.

2.1.5 For the purpose of these *Rules* (this Code), the position of the moulded line for different containment systems is shown in figures 2.5 (a) to (e).



IACS interpretation

Unless explicitly stipulated otherwise in the text of the regulations in SOLAS, Load Line and MARPOL Conventions and any of their mandatory Codes (in this case the IGC Code), distances are to be measured by using moulded dimensions. (IACS UI SC224)

2.2 Freeboard and stability

2.2.1 Ships subject to these *Rules* (the Code) may be assigned the minimum freeboard permitted by the *International Convention on Load Lines* in force. However, the draught associated with the assignment shall not be greater than the maximum draught otherwise permitted by these *Rules* (this Code).

2.2.2 The stability of the ship, in all seagoing conditions and during loading and unloading cargo, shall comply with the requirements of the *International Code on Intact Stability*² This includes partial filling and loading and unloading at sea, when applicable. Stability during ballast water operations shall fulfil stability criteria.

² Refer to the *International Code on Intact Stability, 2008 (2008 IS Code)*, adopted by the Maritime Safety Committee of the Organization by resolution MSC.267(85).

2.2.3 When calculating the effect of free surfaces of consumable liquids for loading conditions, it shall be assumed that, for each type of liquid, at least one transverse pair or a single centre tank has a free surface. The tank or combination of tanks to be taken into account shall be those where the effect of free surfaces is the greatest. The free surface effect in undamaged compartments shall be calculated by a method according to the *International Code on Intact Stability*.

2.2.4 Solid ballast shall not normally be used in double bottom spaces in the cargo area. Where, however, because of stability considerations, the fitting of solid ballast in such spaces becomes unavoidable, its disposition shall be governed by the need to enable access for inspection and to ensure that the impact loads resulting from bottom damage are not directly transmitted to the cargo tank structure.

2.2.5 The master of the ship shall be supplied with a loading and stability information booklet. This booklet shall contain details of typical service conditions, loading, unloading and ballasting operations, provisions for evaluating other conditions of loading and a summary of the ship's survival capabilities. The booklet shall also contain sufficient information to enable the master to load and operate the ship in a safe and seaworthy manner.

2.2.6 All ships, subject to these *Rules* (the Code) shall be fitted with a stability instrument, capable of verifying compliance with intact and damage stability requirements, approved by the Administration having regard to the performance standards recommended by the Organization³.

- .1 ships constructed before 1 July 2016 shall comply with this paragraph at the first scheduled renewal survey of the ship after 1 July 2016 but not later than 1 July 2021;
- .2 notwithstanding the requirements of paragraph 2.2.6.1 a stability instrument installed on a ship constructed before 1 July 2016 need not be replaced provided it is capable of verifying compliance with intact and damage stability, to the satisfaction of the Administration; and
- .3 for the purposes of control under SOLAS regulation XI-1/4, the Administration shall issue a document of approval for the stability instrument.

³ Refer to part B, Chapter 4, of the *International Code on Intact Stability, 2008 (2008 IS Code)*, as amended; the *Guidelines for the Approval of Stability Instruments* (MSC.1/Circ.1229), annex, section 4, as amended; and the technical standards defined in part 1 of the *Guidelines for verification of damage stability requirements for tankers* (MSC.1/Circ.1461).

2.2.7 The Administration may waive the requirements of paragraph 2.2.6 for the following ships, provided the procedures employed for intact and damage stability verification maintain the same degree of safety, as being loaded in accordance with the approved conditions⁴. Any such waiver shall be duly noted on the *International Certificate of Fitness* referred to in paragraph 1.4.4:

- .1 ships which are on a dedicated service, with a limited number of permutations of loading such that all anticipated conditions have been approved in the stability information provided to the master in accordance with the requirements of paragraph 2.2.5;
- .2 ships where stability verification is made remotely by a means approved by the Administration;
- .3 ships which are loaded within an approved range of loading conditions; or
- .4 ships constructed before 1 July 2016 provided with approved limiting *KG/GM* curves covering all applicable intact and damage stability requirements.

⁴ Refer to operational guidance provided in part 2 of the *Guidelines for verification of damage stability requirements for tankers* (MSC.1/Circ.1461).

2.2.8 Conditions of loading

Damage survival capability shall be investigated on the basis of loading information submitted to the Administration for all anticipated conditions of loading and variations in draught and trim. This shall include ballast and, where applicable, cargo heel.

2.3 Damage assumptions

2.3.1 The assumed maximum extent of damage shall be:

.1	Side damage:		
.1.1	Longitudinal extent:	1/3 $L^{2/3}$ or 14.5 m, whichever is less	
.1.2	Transverse extent: measured inboard from the moulded line of the outer shell at right angles to the centreline at the level of the summer waterline	$B/5$ or 11.5 m, whichever is less	
.1.3	Vertical extent: from the moulded line of the outer shell	Upwards, without limit	
.2	Bottom damage:	For 0.3 L from the forward perpendicular of the ship	Any other part of the ship
.2.1	Longitudinal extent:	1/3 $L^{2/3}$ or 14.5 m, whichever is less	1/3 $L^{2/3}$ or 14.5 m, whichever is less
.2.2	Transverse extent:	$B/6$ or 10 m, whichever is less	$B/6$ or 5 m, whichever is less
.2.3	Vertical extent:	$B/15$ or 2 m, whichever is less, measured from the moulded line of the bottom shell plating at centreline (see 2.4.3)	$B/15$ or 2 m, whichever is less, measured from the moulded line of the bottom shell plating at centreline (see 2.4.3)

2.3.2 Other damage

2.3.2.1 If any damage of a lesser extent than the maximum damage specified in 2.3.1 would result in a more severe condition, such damage shall be assumed.

2.3.2.2 Local damage anywhere in the cargo area extending inboard distance "d" as defined in 2.4.1, measured normal to the moulded line of the outer shell shall be considered. Bulkheads shall be assumed damaged when the relevant subparagraphs of 2.6.1 apply. If a damage of a lesser extent than "d" would result in a more severe condition, such damage shall be assumed.

2.4 Location of cargo tanks

2.4.1 Cargo tanks shall be located at the following distances inboard:

- .1** Type 1G ships: from the moulded line of the outer shell, not less than the transverse extent of damage specified in 2.3.1.1.2 and, from the moulded line of the bottom shell at centreline, not less than the vertical extent of damage specified in 2.3.1.2.3, and nowhere less than "d" where "d" is as follows:
 - .1** for V_c below or equal 1,000 m³, $d = 0.8$ m;
 - .2** for $1,000 \text{ m}^3 < V_c < 5,000 \text{ m}^3$, $d = 0.75 + V_c \times 0.2/4,000$ m;
 - .3** for $5,000 \text{ m}^3 \leq V_c < 30,000 \text{ m}^3$, $d = 0.8 + V_c / 25,000$ m; and
 - .4** for $V_c \geq 30,000 \text{ m}^3$, $d = 2$ m,where:
 - V_c corresponds to 100% of the gross design volume of the individual cargo tank at 20°C, including domes and appendages (see figures 2.1 and 2.2). For the purpose of cargo tank protective distances, the cargo tank volume is the aggregate volume of all the parts of tank that have a common bulkhead(s); and
 - "d" is measured at any cross section at a right angle from the moulded line of outer shell.

Tank size limitations may apply to type 1G ship cargoes in accordance with Chapter 17.

- .2** Types 2G/2PG: from the moulded line of the bottom shell at centreline not less than the vertical extent of damage specified in 2.3.1.2.3 and nowhere less than "d" as indicated in 2.4.1.1 (see figures 2.1 and 2.3).
- .3** Type 3G ships: from the moulded line of the bottom shell at centreline not less than the vertical extent of damage specified in 2.3.1.2.3 and nowhere less than "d", where "d" = 0.8 m from the moulded line of outer shell (see figures 2.1 and 2.4).

2.4.2 For the purpose of tank location, the vertical extent of bottom damage shall be measured to the inner bottom when membrane or semi-membrane tanks are used, otherwise to the bottom of the cargo tanks. The transverse extent of side damage shall be measured to the longitudinal bulkhead when membrane or semi-membrane tanks are used, otherwise to the side of the cargo tanks. The distances indicated in 2.3 and 2.4 shall be applied as in figures 2.5(a) to (e). These distances shall be measured plate to plate, from the moulded line to the moulded line, excluding insulation.

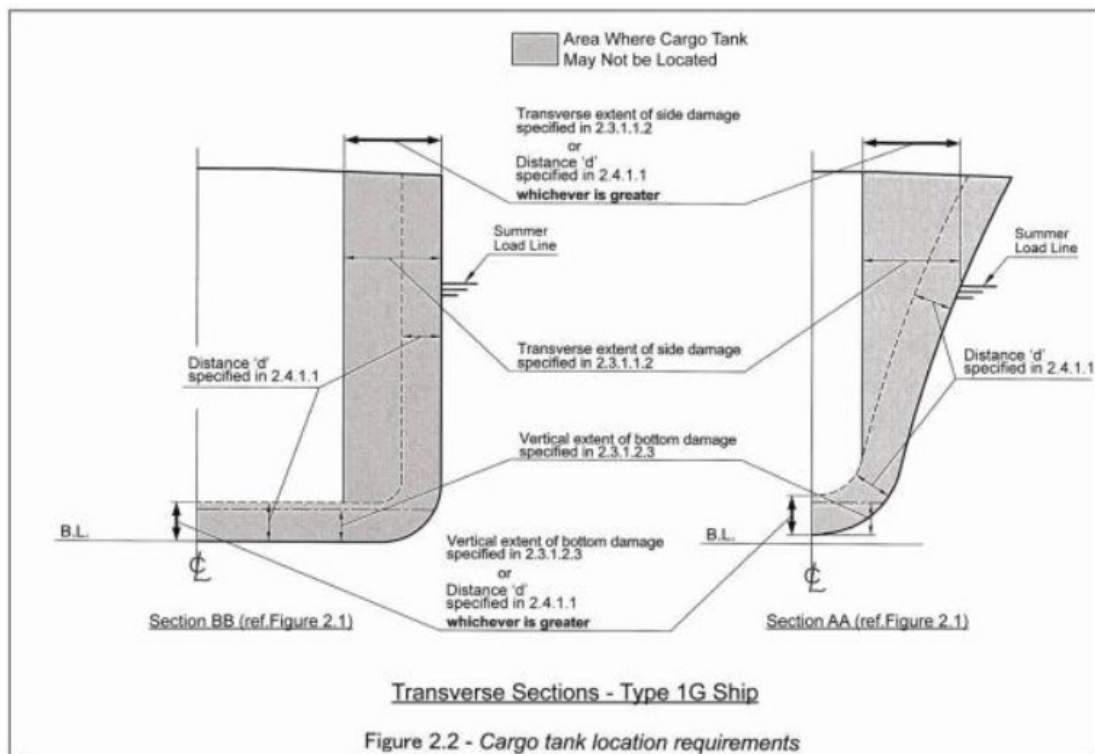
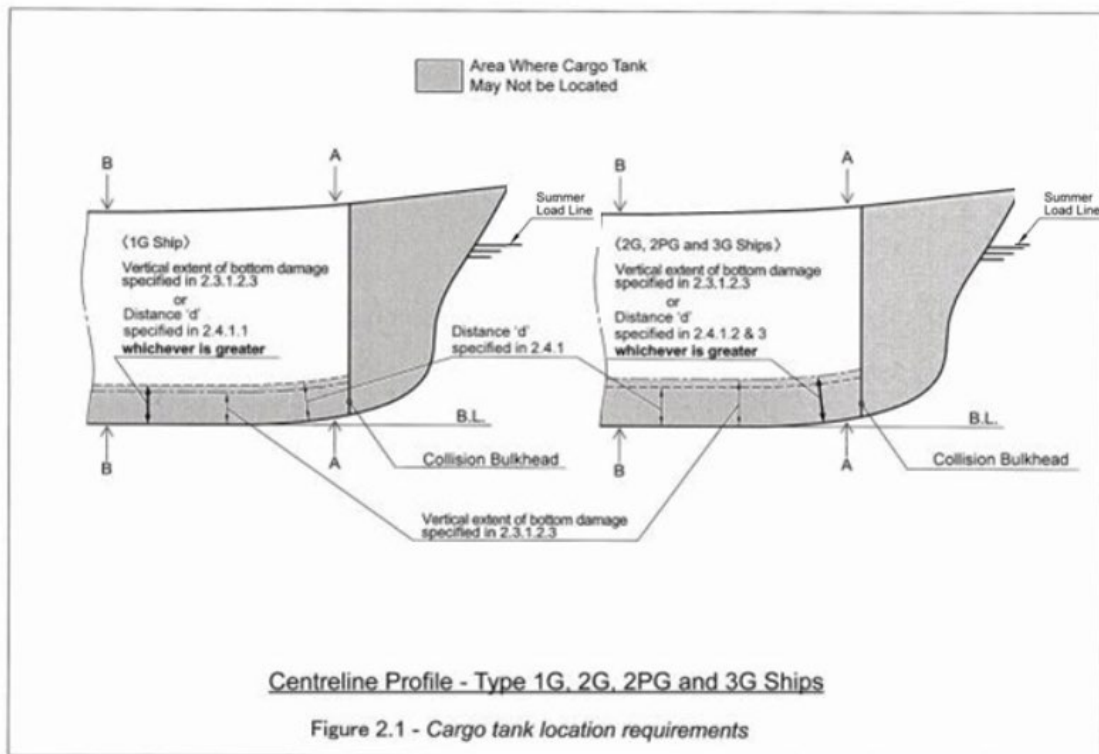

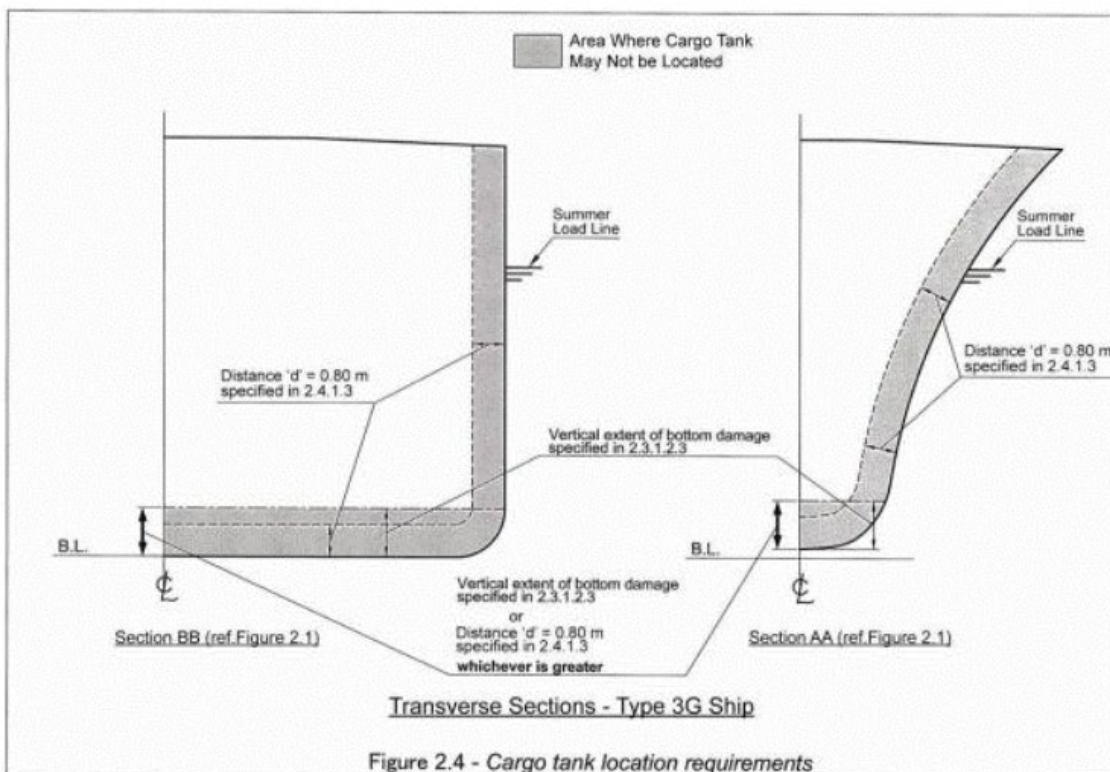
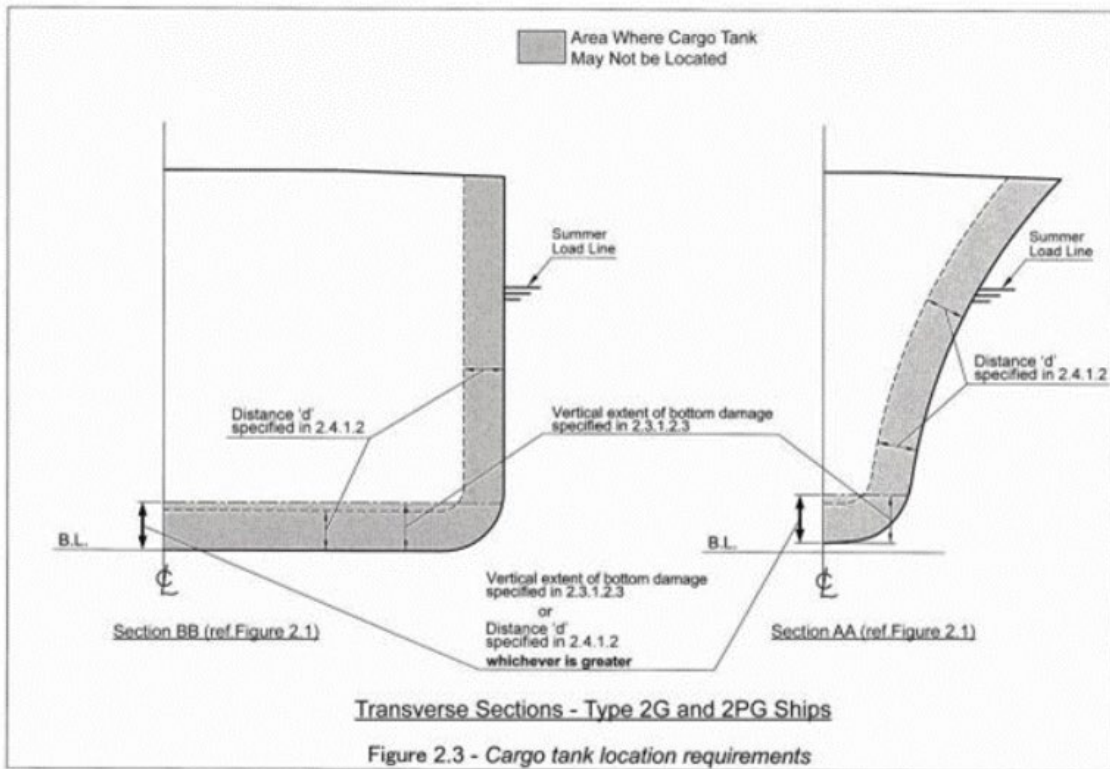

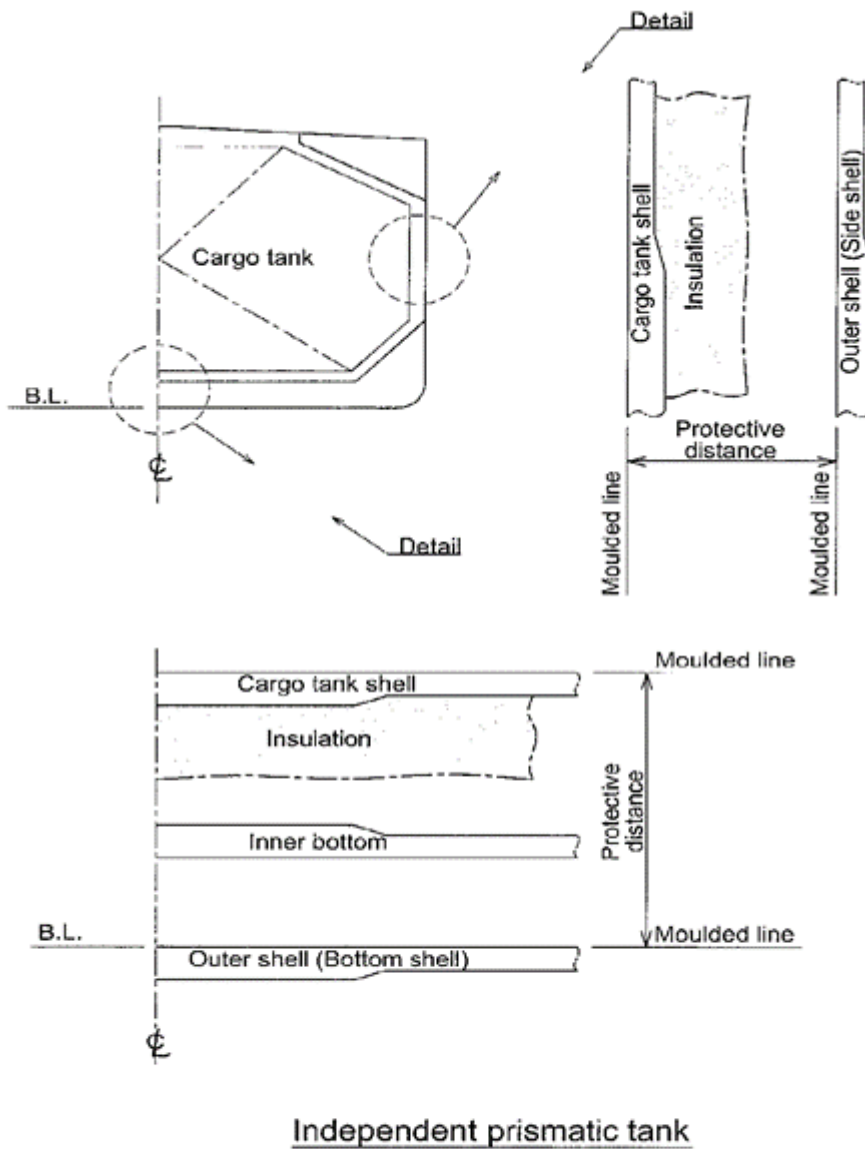

Figure 2.5(a) - Protective distance

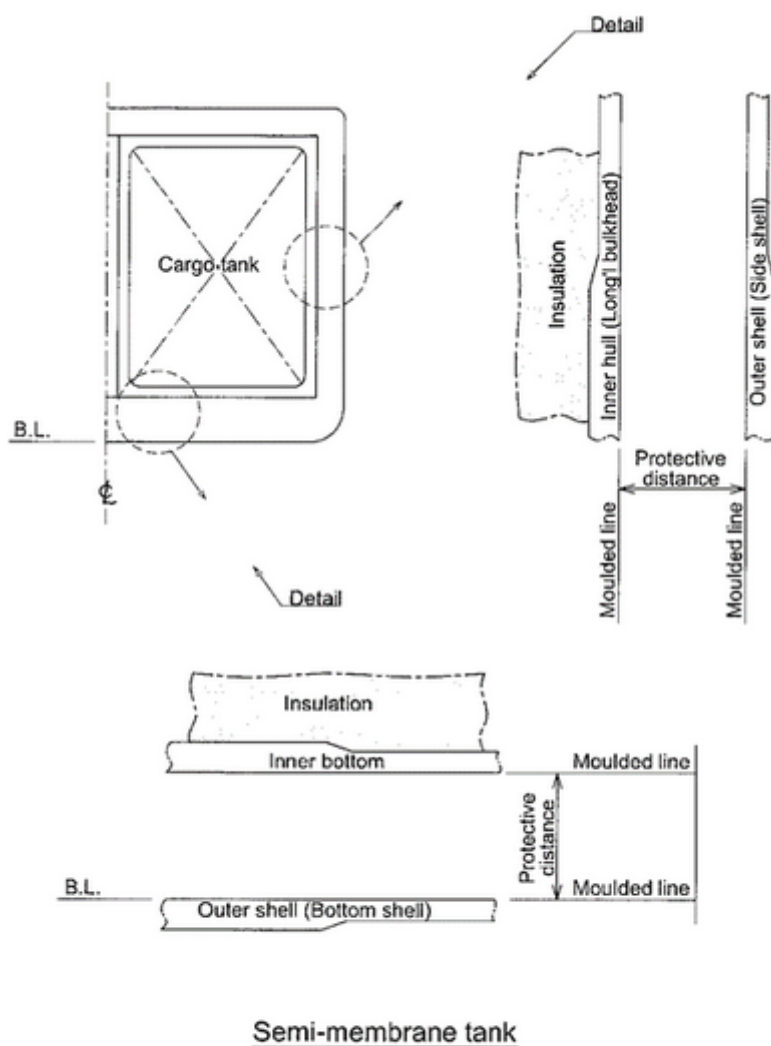

Figure 2.5(b) - Protective distance

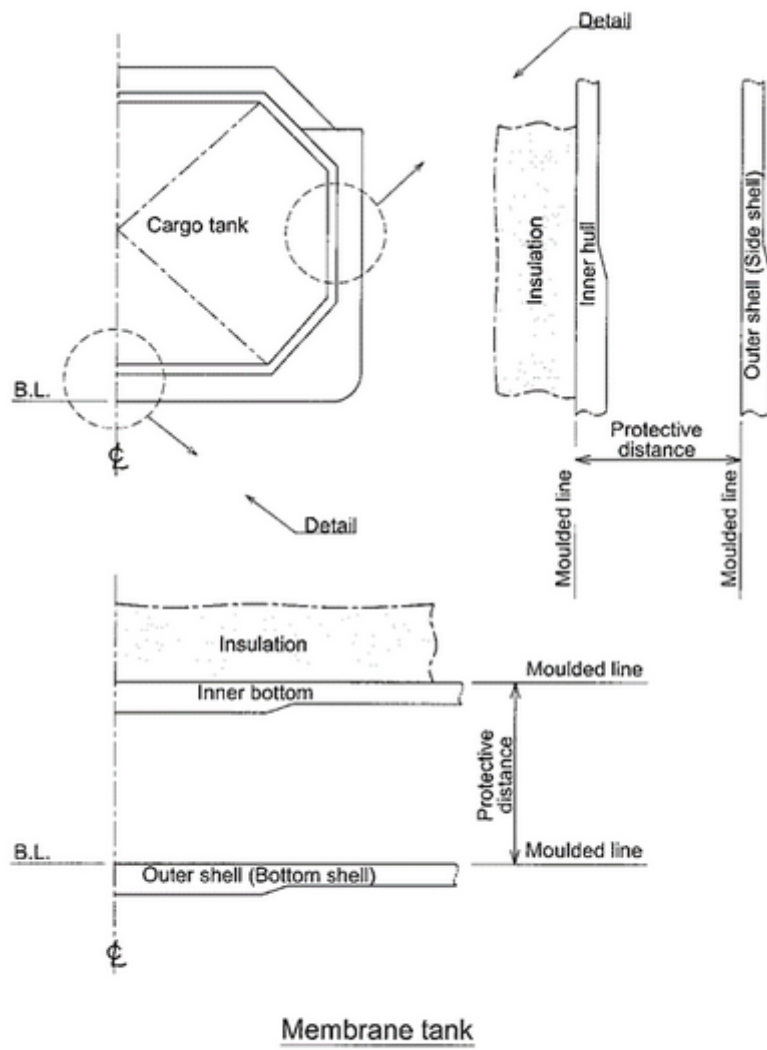

Figure 2.5(c) - Protective distance

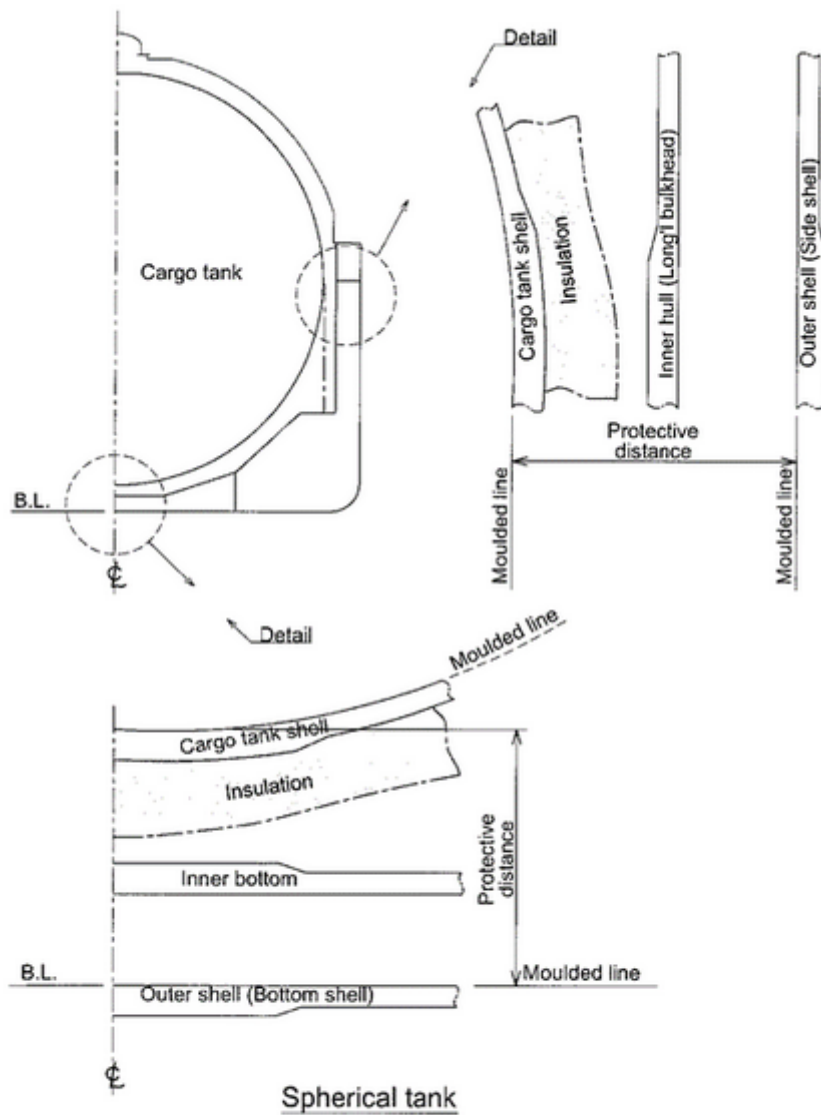
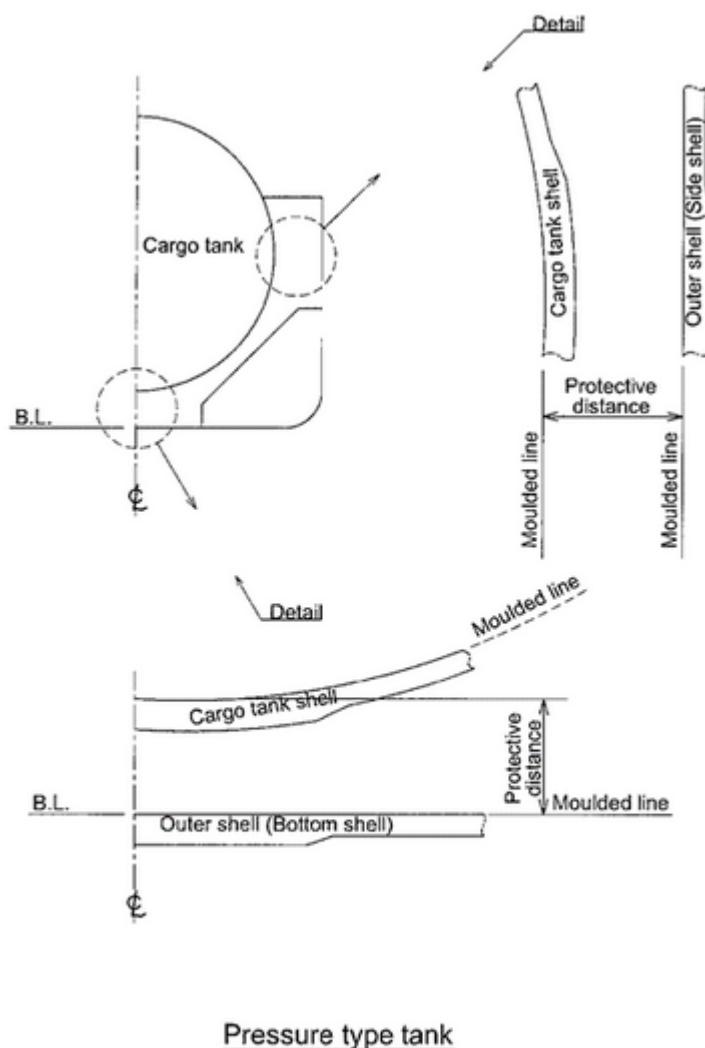

Figure 2.5(d) - Protective distance



Pressure type tank

Figure 2.5(e) - Protective distance

2.4.3 Except for type 1G ships, suction wells installed in cargo tanks may protrude into the vertical extent of bottom damage specified in 2.3.1.2.3 provided that such wells are as small as practicable and the protrusion below the inner bottom plating does not exceed 25% of the depth of the double bottom or 350 mm, whichever is less. Where there is no double bottom, the protrusion below the upper limit of bottom damage shall not exceed 350 mm. Suction wells installed in accordance with this paragraph may be ignored when determining the compartments affected by damage.

2.4.4 Cargo tanks shall not be located forward of the collision bulkhead.

2.5 Flood assumptions

2.5.1 The requirements of 2.7 shall be confirmed by calculations that take into consideration the design characteristics of the ship, the arrangements, configuration and contents of the damaged compartments, the distribution, relative densities and the free surface effects of liquids and the draught and trim for all conditions of loading.

2.5.2 The permeabilities of spaces assumed to be damaged shall be as follows:

Spaces	Permeabilities
Stores	0.6
Accommodation	0.95
Machinery	0.85
Voids	0.95
Hold spaces	0.95 ¹
Consumable liquids	0 to 0.95 ²
Other liquids	0 to 0.95 ²
<p>Note 1 Other values of permeability can be considered based on the detailed calculations. Interpretations of regulation of part B-1 of SOLAS Chapter II-1 (MSC/Circ.651) are referred.</p> <p>Note 2 The permeability of partially filled compartments shall be consistent with the amount of liquid carried in the compartment.</p>	

2.5.3 Wherever damage penetrates a tank containing liquids, it shall be assumed that the contents are completely lost from that compartment and replaced by salt water up to the level of the final plane of equilibrium.

2.5.4 Where the damage between transverse watertight bulkheads is envisaged, as specified in 2.6.1.4, 2.6.1.5, and 2.6.1.6, transverse bulkheads shall be spaced at least at a distance equal to the longitudinal extent of damage specified in 2.3.1.1.1 in order to be considered effective. Where transverse bulkheads are spaced at a lesser distance, one or more of these bulkheads within such extent of damage shall be assumed as non-existent for the purpose of determining flooded compartments. Further, any portion of a transverse bulkhead bounding side compartments or double bottom compartments shall be assumed damaged if the watertight bulkhead boundaries are within the extent of vertical or horizontal penetration required by 2.3. Also, any transverse bulkhead shall be assumed damaged if it contains a step or recess of more than 3 m in length located within the extent of penetration of assumed damage. The step formed by the after peak bulkhead and the after peak tank top shall not be regarded as a step for the purpose of this paragraph.

2.5.5 The ship shall be designed to keep unsymmetrical flooding to the minimum consistent with efficient arrangements.

2.5.6 Equalization arrangements requiring mechanical aids such as valves or cross-levelling pipes, if fitted, shall not be considered for the purpose of reducing an angle of heel or attaining the minimum range of residual stability to meet the requirements of 2.7.1, and sufficient residual stability shall be maintained during all stages where equalization is used. Spaces linked by ducts of large cross-sectional area may be considered to be common.

2.5.7 If pipes, ducts, trunks or tunnels are situated within the assumed extent of damage penetration, as defined in 2.3, arrangements shall be such that progressive flooding cannot thereby extend to compartments other than those assumed to be flooded for each case of damage.

2.5.8 The buoyancy of any superstructure directly above the side damage shall be disregarded. However, the unflooded parts of superstructures beyond the extent of damage may be taken into consideration, provided that:

- .1 they are separated from the damaged space by watertight divisions and the requirements of 2.7.1.1 in respect of these intact spaces are complied with; and

- .2 openings in such divisions are capable of being closed by remotely operated sliding watertight doors and unprotected openings are not immersed within the minimum range of residual stability required in 2.7.2.1. However, the immersion of any other openings capable of being closed weathertight may be permitted.

IMO interpretation

The longitudinal extent of damage to superstructure in the instance of side damage to a machinery space aft under paragraph 2.5.8 (2.8.1) should be the same as the longitudinal extent of the side damage to the machinery space (see figure 1).

Note:

Number of referenced paragraph has been changed to correspond to the latest version of IGC Code cited here.

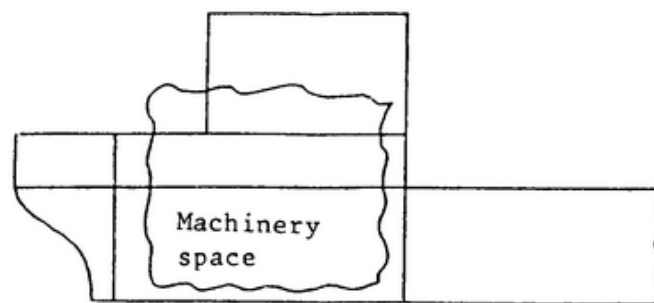

Figure 1 – Longitudinal extent of damage to superstructure

(MSC/Circ.406/Rev.1)

2.6 Standard of damage

2.6.1 Ships shall be capable of surviving the damage indicated in 2.3 with the flood assumptions in 2.5, to the extent determined by the ship's type, according to the following standards:

- .1 a type 1G ship shall be assumed to sustain damage anywhere in its length;
- .2 a type 2G ship of more than 150 m in length shall be assumed to sustain damage anywhere in its length;
- .3 a type 2G ship of 150 m in length or less shall be assumed to sustain damage anywhere in its length, except involving either of the bulkheads bounding a machinery space located aft;
- .4 a type 2PG ship shall be assumed to sustain damage anywhere in its length except involving transverse bulkheads spaced further apart than the longitudinal extent of damage as specified in 2.3.1.1.1;
- .5 a type 3G ship of 80 m in length or more shall be assumed to sustain damage anywhere in its length, except involving transverse bulkheads spaced further apart than the longitudinal extent of damage specified in 2.3.1.1.1; and
- .6 a type 3G ship less than 80 m in length shall be assumed to sustain damage anywhere in its length, except involving transverse bulkheads spaced further apart than the longitudinal extent of damage specified in 2.3.1.1.1 and except damage involving the machinery space when located after.

Note:

IMO interpretation in 2.5.8 also applies to this 2.6.1.

2.6.2 In the case of small type 2G/2PG and 3G ships that do not comply in all respects with the appropriate requirements of 2.6.1.3, 2.6.1.4 and 2.6.1.6, special dispensations may only be considered by the Administration provided that alternative measures can be taken which

maintain the same degree of safety. The nature of the alternative measures shall be approved and clearly stated and be available to the port Administration. Any such dispensation shall be duly noted on the *International Certificate of Fitness for the Carriage of Liquefied Gases in Bulk* referred to in 1.4.4.

2.7 Survival requirements

Ships subject to these *Rules* (the Code) shall be capable of surviving the assumed damage specified in 2.3, to the standard provided in 2.6, in a condition of stable equilibrium and shall satisfy the following criteria.

2.7.1 In any stage of flooding:

- .1 the waterline, taking into account sinkage, heel and trim, shall be below the lower edge of any opening through which progressive flooding or downflooding may take place. Such openings shall include air pipes and openings that are closed by means of weathertight doors or hatch covers and may exclude those openings closed by means of watertight manhole covers and watertight flush scuttles, small watertight cargo tank hatch covers that maintain the high integrity of the deck, remotely operated watertight sliding doors, hinged watertight access doors with open/closed indication locally and at the navigation bridge, of the quick-acting or single-action type that are normally closed at sea, hinged watertight doors that are permanently closed at sea, and sidescuttles of the non-opening type. Doors in watertight bulkhead shall comply with the requirements of *PKiBSM, Part III, 21.2.1* and 21.2.2;
- .2 the maximum angle of heel due to unsymmetrical flooding shall not exceed 30°; and
- .3 the residual stability during intermediate stages of flooding shall not be less than that required by 2.7.2.1.

2.7.2 At final equilibrium after flooding:

- .1 the righting lever curve shall have a minimum range of 20° beyond the position of equilibrium in association with a maximum residual righting lever of at least 0.1 m within the 20° range; the area under the curve within this range shall not be less than 0.0175 m-radians. The 20° range may be measured from any angle commencing between the position of equilibrium and the angle of 25° (or 30° if no deck immersion occurs). Unprotected openings shall not be immersed within this range unless the space concerned is assumed to be flooded. Within this range, the immersion of any of the openings listed in 2.7.1.1 and other openings capable of being closed weathertight may be permitted; and

IACS and IMO interpretation

Unprotected openings

Other openings capable of being closed weathertight do not include ventilators (complying with ILLC 19(4)) that for operational reasons have to remain open to supply air to the engine room or emergency generator room (if the same is considered buoyant in the stability calculation or protecting openings leading below) for the effective operation of the ship. (IACS UI GC17, MSC.1/Circ.1543)

- .2 the emergency source of power shall be capable of operating.

CHAPTER 3
(IGC Code Chapter 3)

Goal

To ensure that the cargo containment and handling system are located such that the consequences of any release of cargo will be minimized, and to provide safe access for operation and inspection.

3 SHIP ARRANGEMENTS

3.1 Segregation of the cargo area

3.1.1 Hold spaces shall be segregated from machinery and boiler spaces, accommodation spaces, service spaces, control stations, chain lockers, domestic water tanks and from stores. Hold spaces shall be located forward of machinery spaces of category A. Alternative arrangements, including locating machinery spaces of category A forward, may be accepted, based on SOLAS regulation II-2/17, after further consideration of involved risks, including that of cargo release and the means of mitigation.

3.1.2 Where cargo is carried in a cargo containment system not requiring a complete or partial secondary barrier, segregation of hold spaces from spaces referred to in 3.1.1 or spaces either below or outboard of the hold spaces may be effected by cofferdams, oil fuel tanks or a single gastight bulkhead of all-welded construction forming an "A-60" class division. A gastight "A-0" class division is acceptable if there is no source of ignition or fire hazard in the adjoining spaces.

3.1.3 Where cargo is carried in a cargo containment system requiring a complete or partial secondary barrier, segregation of hold spaces from spaces referred to in 3.1.1, or spaces either below or outboard of the hold spaces that contain a source of ignition or fire hazard, shall be effected by cofferdams or oil fuel tanks. A gastight "A-0" class division is acceptable if there is no source of ignition or fire hazard in the adjoining spaces.

3.1.4 Turret compartments segregation from spaces referred to in 3.1.1, or spaces either below or outboard of the turret compartment that contain a source of ignition or fire hazard, shall be effected by cofferdams or an A-60 class division. A gastight "A-0" class division is acceptable if there is no source of ignition or fire hazard in the adjoining spaces.

3.1.5 In addition, the risk of fire propagation from turret compartments to adjacent spaces shall be evaluated by a risk analysis (see 1.1.11) and further preventive measures, such as the arrangement of a cofferdam around the turret compartment, shall be provided if needed.

3.1.6 When cargo is carried in a cargo containment system requiring a complete or partial secondary barrier:

- .1 at temperatures below -10°C, hold spaces shall be segregated from the sea by a double bottom; and
- .2 at temperatures below -55°C, the ship shall also have a longitudinal bulkhead forming side tanks.

3.1.7 Arrangements shall be made for sealing the weather decks in way of openings for cargo containment systems.

3.2 Accommodation, service and machinery spaces and control stations

3.2.1 No accommodation space, service space or control station shall be located within the cargo area. The bulkhead of accommodation spaces, service spaces or control stations that face the cargo area shall be so located as to avoid the entry of gas from the hold space to such spaces through a single failure of a deck or bulkhead on a ship having a containment system requiring a secondary barrier.

3.2.2 To guard against the danger of hazardous vapours, due consideration shall be given to the location of air intakes/outlets and openings into accommodation, service and machinery spaces and control stations in relation to cargo piping, cargo vent systems and machinery space exhausts from gas burning arrangements.

IMO interpretation

Compliance with other relevant paragraphs of these Rules (the Code) and in particular with paragraphs 3.2.4.1 to 3.2.4.3 (3.2.4), 3.8, 8.2.11.1 to 8.2.11.2 (8.2.10) and 12.1.5 (12.1.6) where applicable would also ensure compliance with this paragraph. (MSC/Circ.406/Rev.1)

Note:

Numbers of referenced paragraphs have been changed to correspond to the latest edition of IGC Code cited here.

3.2.3 Access through doors, gastight or otherwise, shall not be permitted from a non-hazardous area to a hazardous area except for access to service spaces forward of the cargo area through airlocks, as permitted by 3.6.1, when accommodation spaces are aft.

3.2.4 Location of various openings

3.2.4.1 Entrances, air inlets* and openings to accommodation spaces, service spaces, machinery spaces and control stations shall not face the cargo area. They shall be located on the end bulkhead not facing the cargo area or on the outboard side of the superstructure or deckhouse or on both at a distance of at least 4% of the length (L) of the ship but not less than 3 m from the end of the superstructure or deckhouse facing the cargo area. This distance, however, need not exceed 5 m.

*** IMO interpretation**

Air outlets are subject to the same requirements as air inlets and air intakes.. (MSC/Circ.406/Rev.1)

3.2.4.2 Windows and sidescuttles facing the cargo area and on the sides of the superstructures or deckhouses within the distance mentioned above shall be of the fixed (non-opening) type. Wheelhouse windows may be non-fixed and wheelhouse doors may be located within the above limits so long as they are designed in a manner that a rapid and efficient gas and vapour tightening of the wheelhouse can be ensured.

3.2.4.3 For ships dedicated to the carriage of cargoes that have neither flammable nor toxic hazards, the Administration may approve relaxations from the above requirements.

3.2.4.4 Accesses to forecastle spaces containing sources of ignition may be permitted through a single door facing the cargo area, provided the doors are located outside hazardous areas as defined in Chapter 10.

3.2.5 Windows and sidescuttles facing the cargo area and on the sides of the superstructures and deckhouses within the limits specified in 3.2.4, except wheelhouse windows, shall be constructed to "A-60" class. Sidescuttles in the shell below the uppermost continuous deck and in the first tier of the superstructure or deckhouse shall be of fixed (non-opening) type.

3.2.6 All air intakes, outlets and other openings into the accommodation spaces, service spaces and control stations shall be fitted with closing devices. When carrying toxic products, they shall be capable of being operated from inside the space. The requirement for fitting air intakes and openings with closing devices operated from inside the space for toxic products need not apply to spaces not normally manned, such as deck stores, forecastle stores, workshops. In addition, the requirement does not apply to cargo control rooms located within the cargo area.

IACS and IMO interpretation

Closing devices for air intakes

1. The closing devices that need not be operable from within the single spaces and may be located in centralized positions.
2. Engine room casings, cargo machinery spaces, electric motor rooms and steering gear compartments are generally considered as spaces not covered by paragraph 3.2.6 and therefore the requirement for closing devices need not be applied to these spaces.
3. The closing device should give a reasonable degree of gas tightness. Ordinary steel fire-flaps without gaskets/seals should not be considered satisfactory.
4. Regardless of this interpretation, the closing devices shall be operable from outside of the protected space (SOLAS regulation II-2/5.2.1.1). (IACS UI GC15, MSC.1/Circ.1559)

3.2.7 Control rooms and machinery spaces of turret systems may be located in the cargo area forward or aft of cargo tanks in ships with such installations. Access to such spaces containing sources of ignition may be permitted through doors facing the cargo area, provided the doors are located outside hazardous areas or access is through airlocks.

3.3 Cargo machinery spaces and turret compartments

3.3.1 Cargo machinery spaces shall be situated above the weather deck and located within the cargo area. Cargo machinery spaces and turret compartments shall be treated as cargo pump-rooms for the purpose of fire protection according to SOLAS regulation II-2/9.2.4, and for the purpose of prevention of potential explosion according to SOLAS regulation II-2/4.5.10.

IMO interpretation

The sentence "for the purpose of prevention of potential explosion according to SOLAS regulation II-2/4.5.10 in paragraph 3.3.1 does not require application of the aforementioned SOLAS regulation. SOLAS regulation II-2/4.5.10 does not apply in accordance with paragraph 11.1.1.1 of the IGC Code and these Rules. (MSC.1/Circ.1559)

3.3.2 When cargo machinery spaces are located at the after end of the aftermost hold space or at the forward end of the foremost hold space, the limits of the cargo area, as defined in 1.2.7, shall be extended to include the cargo machinery spaces for the full breadth and depth of the ship and the deck areas above those spaces.

3.3.3 Where the limits of the cargo area are extended by 3.3.2, the bulkhead that separates the cargo machinery spaces from accommodation and service spaces, control stations and machinery spaces of category A shall be located so as to avoid the entry of gas to these spaces through a single failure of a deck or bulkhead.

3.3.4 Cargo compressors and cargo pumps may be driven by electric motors in an adjacent non-hazardous space separated by a bulkhead or deck, if the seal around the bulkhead penetration ensures effective gastight segregation of the two spaces. Alternatively, such equipment may be driven by certified safe electric motors adjacent to them if the electrical installation complies with the requirements of Chapter 10.

3.3.5 Arrangements of cargo machinery spaces and turret compartments shall ensure safe unrestricted access for personnel wearing protective clothing and breathing apparatus, and in the event of injury to allow unconscious personnel to be removed. At least two widely separated escape routes and doors shall be provided in cargo machinery spaces, except that a single escape route may be accepted where the maximum travel distance to the door is 5 m or less.

3.3.6 All valves necessary for cargo handling shall be readily accessible to personnel wearing protective clothing. Suitable arrangements shall be made to deal with drainage of pump and compressor rooms.

3.3.7 Turret compartments shall be designed to retain their structural integrity in case of explosion or uncontrolled high-pressure gas release (overpressure and/or brittle fracture), the characteristics of which shall be substantiated on the basis of a risk analysis with due consideration of the capabilities of the pressure relieving devices.

3.4 Cargo control rooms

3.4.1 Any cargo control room shall be above the weather deck and may be located in the cargo area. The cargo control room may be located within the accommodation spaces, service spaces or control stations, provided the following conditions are complied with:

- .1** the cargo control room is a non-hazardous area;
- .2** if the entrance complies with 3.2.4.1, the control room may have access to the spaces described above; and
- .3** if the entrance does not comply with 3.2.4.1, the cargo control room shall have no access to the spaces described above and the boundaries for such spaces shall be insulated to "A-60" class.

3.4.2 If the cargo control room is designed to be a non-hazardous area, instrumentation shall, as far as possible, be by indirect reading systems and shall, in any case, be designed to prevent any escape of gas into the atmosphere of that space. Location of the gas detection system within the cargo control room will not cause the room to be classified as a hazardous area, if installed in accordance with 13.6.11.

3.4.3 If the cargo control room for ships carrying flammable cargoes is classified as a hazardous area, sources of ignition shall be excluded and any electrical equipment shall be installed in accordance with Chapter 10.

3.5 Access to spaces in the cargo area

3.5.1 Visual inspection of at least one side of the inner hull structure shall be possible without the removal of any fixed structure or fitting. If such a visual inspection, whether combined with those inspections required in 3.5.2, 4.6.2.4 or 4.20.3.7 or not, is only possible at the outer face of the inner hull, the inner hull shall not be a fuel-oil tank boundary wall.

3.5.2 Inspection of one side of any insulation in hold spaces shall be possible. If the integrity of the insulation system can be verified by inspection of the outside of the hold space boundary when tanks are at service temperature, inspection of one side of the insulation in the hold space need not be required.

3.5.3 Arrangements for hold spaces, void spaces, cargo tanks and other spaces classified as hazardous areas, shall be such as to allow entry and inspection of any such space by personnel wearing protective clothing and breathing apparatus and shall also allow for the evacuation of injured and/or unconscious personnel. Such arrangements shall comply with the following:

- .1 Access shall be provided as follows:
 - .1 access to all cargo tanks. Access shall be direct from the weather deck;
 - .2 access through horizontal openings, hatches or manholes. The dimensions shall be sufficient to allow a person wearing a breathing apparatus to ascend or descend any ladder without obstruction, and also to provide a clear opening to facilitate the hoisting of an injured person from the bottom of the space. The minimum clear opening shall be not less than 600 mm x 600 mm;

IACS and IMO interpretation

Cargo tank clearances

The minimum clear opening of 600 mm x 600 mm may have corner radii up to 100 mm maximum. In such a case where as a consequence of structural analysis of a given design the stress is to be reduced around the opening, it is considered appropriate to take measures to reduce the stress such as making the opening larger with increased radii, e.g. 600 x 800 with 300 mm radii, in which a clear opening of 600 mm x 600 mm with corner radii up to 100 mm maximum fits. (IACS UI GC16, MSC.1/Circ.1559)

- .3 access through vertical openings or manholes providing passage through the length and breadth of the space. The minimum clear opening shall be not less than 600 mm x 800 mm at a height of not more than 600 mm from the bottom plating unless gratings or other footholds are provided; and

IACS and IMO interpretation

Cargo tank clearances

1. *The minimum clear opening of not less than 600 mm x 800 mm may also include an opening with corner radii of 300 mm. An opening of 600 mm in height x 800 mm in width may be accepted as access openings in vertical structures where it is not desirable to make large opening in the structural strength aspects, i.e. girders and floors in double bottom tanks.*

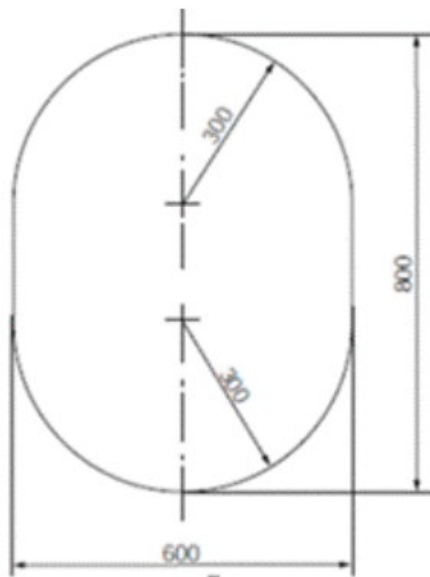

2. *Subject to verification of easy evacuation of injured person on a stretcher the vertical opening 850 mm x 620 mm with wider upper half than 600 mm, while the lower half may be less than 600 mm with the overall height not less than 850 mm is considered an acceptable alternative to the traditional opening of 600 mm x 800 mm with corner radii of 300 mm.*

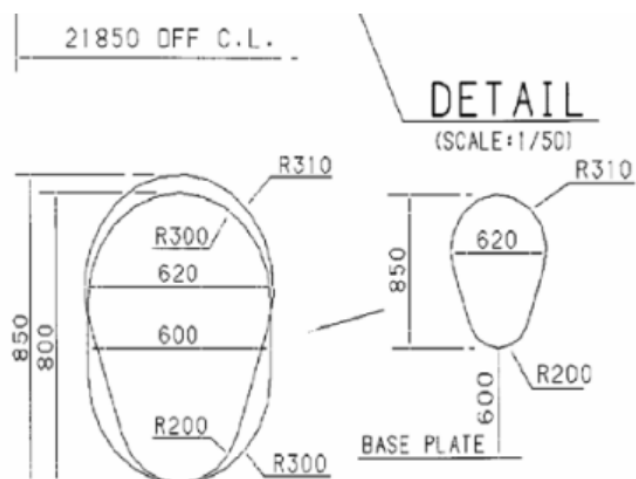

3. If a vertical opening is at a height of more than 600 mm steps and handgrips are to be provided. In such arrangements it is to be demonstrated that an injured person can be easily evacuated. (IACS UI GC16, MSC.1/Circ.1559)
- .4 circular access openings to type C tanks shall have a diameter of not less than 600 mm.
- .2 The dimensions referred to in 3.5.3.1.2 and 3.5.3.1.3 may be decreased, if the requirements of 3.5.3 can be met to the satisfaction of the Administration.
- .3 Where cargo is carried in a containment system requiring a secondary barrier, the requirements of 3.5.3.1.2 and 3.5.3.1.3 do not apply to spaces separated from a hold space by a single gastight steel boundary. Such spaces shall be provided only with direct or indirect access from the weather deck, not including any enclosed non-hazardous area.
- .4 Access required for inspection shall be a designated access through structures below and above cargo tanks, which shall have at least the cross-sections as required by 3.5.3.1.3.
- .5 For the purpose of 3.5.1 or 3.5.2, the following shall apply:
- .1 where it is required to pass between the surface to be inspected, flat or curved, and structures such as deck beams, stiffeners, frames, girders, etc., the distance between that surface and the free edge of the structural elements shall be at least 380 mm. The distance between the surface to be inspected and the surface to which the above structural elements are fitted, e.g. deck, bulkhead or shell, shall be at least 450 mm for a curved tank surface (e.g. for a type C tank), or 600 mm for a flat tank surface (e.g. for a type A tank) (see figure 3.1);

Figure 3.1

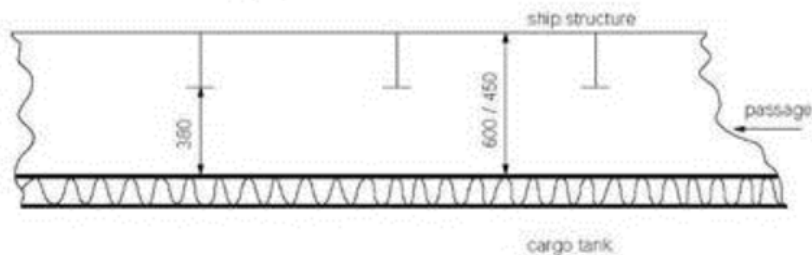

- .2 where it is not required to pass between the surface to be inspected and any part of the structure, for visibility reasons the distance between the free edge of that structural element and the surface to be inspected shall be at least 50 mm or half the breadth of the structure's face plate, whichever is the larger (see figure 3.2);

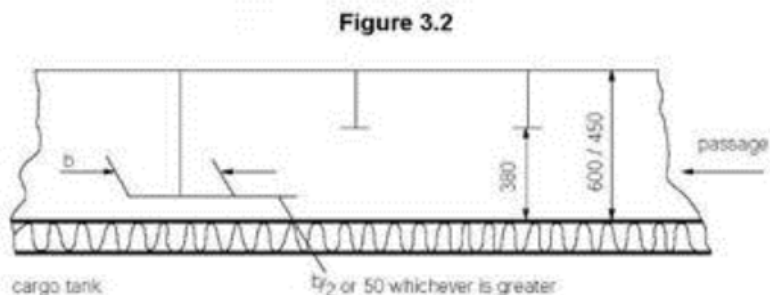

- .3 if for inspection of a curved surface where it is required to pass between that surface and another surface, flat or curved, to which no structural elements are fitted, the distance between both surfaces shall be at least 380 mm (see figure 3.3). Where it is not required to pass between that curved surface and another surface, a smaller distance than 380 mm may be accepted taking into account the shape of the curved surface;

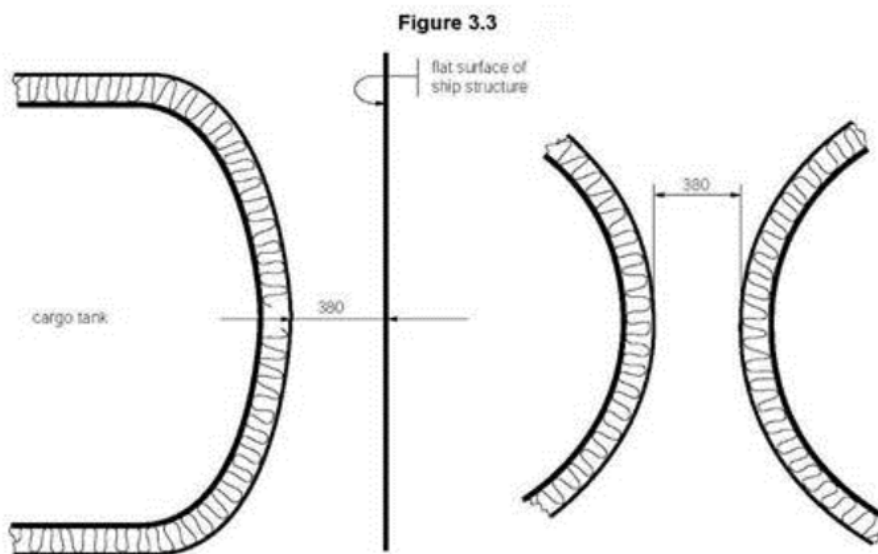

- .4 if for inspection of an approximately flat surface where it is required to pass between two approximately flat and approximately parallel surfaces, to which no structural elements are fitted, the distance between those surfaces shall be at least 600 mm. Where fixed access ladders are fitted, a clearance of at least 450 mm shall be provided for access (see figure 3.4);

Figure 3.4

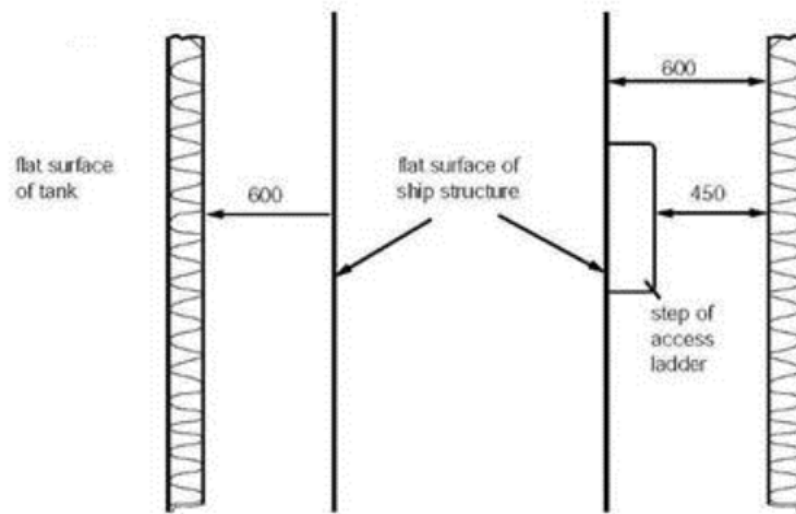

- .5 the minimum distances between a cargo tank sump and adjacent double bottom structure in way of a suction well shall not be less than those shown in figure 3.5 (figure 3.5 shows that the distance between the plane surfaces of the sump and the well is a minimum of 150 mm and that the clearance between the edge between the inner bottom plate, and the vertical side of the well and the knuckle point between the spherical or circular surface and sump of the tank is at least 380 mm). If there is no suction well, the distance between the cargo tank sump and the inner bottom shall not be less than 50 mm;

Figure 3.5

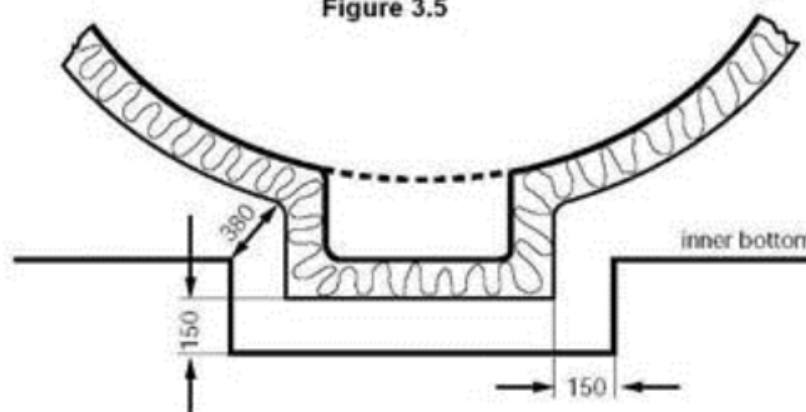

- .6 the distance between a cargo tank dome and deck structures shall not be less than 150 mm (see figure 3.6);

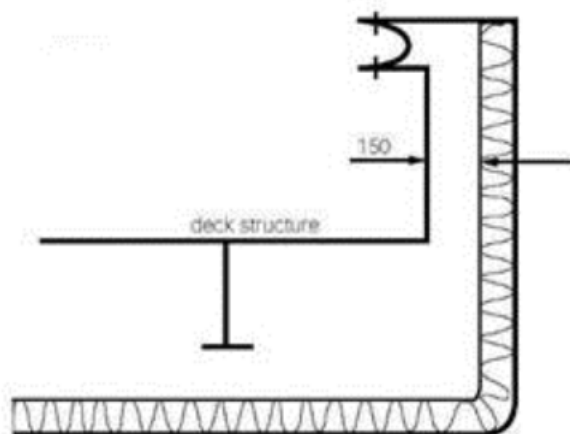

Figure 3.6

- .7 fixed or portable staging shall be installed as necessary for inspection of cargo tanks, cargo tank supports and restraints (e.g. anti-pitching, anti-rolling and anti-flotation chocks), cargo tank insulation etc. This staging shall not impair the clearances specified in 3.5.3.5.1 to 3.5.3.5.4; and
- .8 if fixed or portable ventilation ducting shall be fitted in compliance with 12.1.2, such ducting shall not impair the distances required under 3.5.3.5.1 to 3.5.3.5.4.

3.5.4 Access from the open weather deck to non-hazardous areas shall be located outside the hazardous areas as defined in Chapter 10, unless the access is by means of an airlock in accordance with 3.6.

3.5.5 Turret compartments shall be arranged with two independent means of access/egress.

3.5.6 Access from a hazardous area below the weather deck to a non-hazardous area is not permitted.

3.6 Airlocks

3.6.1 Access between hazardous area on the open weather deck and non-hazardous spaces shall be by means of an airlock. This shall consist of two self-closing, substantially gastight, steel doors without any holding back arrangements, capable of maintaining the overpressure, at least 1.5 m but no more than 2.5 m apart. The airlock space shall be artificially ventilated from a non-hazardous area and maintained at an overpressure to the hazardous area on the weather deck.

3.6.2 Where spaces are protected by pressurization, the ventilation shall be designed and installed in accordance with recognized standards ⁵.

⁵ Such as the recommended publication by the International Electrotechnical Commission, in particular IEC 60092-502:1999.

3.6.3 An audible and visible alarm system to give a warning on both sides of the airlock shall be provided. The visible alarm shall indicate if one door is open. The audible alarm shall sound if doors on both sides of the air lock are moved from the closed positions.

3.6.4 In ships carrying flammable products, electrical equipment that is located in spaces protected by airlocks and not of the certified safe type, shall be de-energized in case of loss of overpressure in the space.

3.6.5 Electrical equipment for manoeuvring, anchoring and mooring, as well as emergency fire pumps that are located in spaces protected by airlocks, shall be of a certified safe type.

3.6.6 The airlock space shall be monitored for cargo vapours (see 13.6.2).

3.6.7 Subject to the requirements of the *International Convention on Load Lines* in force, the door sill shall not be less than 300 mm in height.

3.7 Bilge, ballast and oil fuel arrangements

3.7.1 Where cargo is carried in a cargo containment system not requiring a secondary barrier, suitable drainage arrangements for the hold spaces that are not connected with the machinery space shall be provided. Means of detecting any leakage shall be provided.

3.7.2 Where there is a secondary barrier, suitable drainage arrangements for dealing with any leakage into the hold or insulation spaces through the adjacent ship structure shall be provided. The suction shall not lead to pumps inside the machinery space. Means of detecting such leakage shall be provided.

3.7.3 The hold or interbarrier spaces of type A independent tank ships shall be provided with a drainage system suitable for handling liquid cargo in the event of cargo tank leakage or rupture. Such arrangements shall provide for the return of any cargo leakage to the liquid cargo piping.

3.7.4 Arrangements referred to in 3.7.3 shall be provided with a removable spool piece.

3.7.5 Ballast spaces, including wet duct keels used as ballast piping, oil fuel tanks and non-hazardous spaces, may be connected to pumps in the machinery spaces. Dry duct keels with ballast piping passing through may be connected to pumps in the machinery spaces, provided the connections are led directly to the pumps, and the discharge from the pumps is led directly overboard with no valves or manifolds in either line that could connect the line from the duct keel to lines serving non-hazardous spaces. Pump vents shall not be open to machinery spaces.

IACS and IMO interpretation

Pump vents in machinery spaces

The requirements of "Pump vents should not be open to machinery spaces" and "Pump vents shall not be open to machinery spaces" apply only to pumps in the machinery spaces serving dry duct keels through which ballast piping passes. (IACS UI GC14, MSC.1/Circ.1559)

3.8 Bow and stern loading and unloading arrangements

3.8.1 Subject to the requirements of this section and Chapter 5, cargo piping may be arranged to permit bow or stern loading and unloading.

3.8.2 Bow or stern loading and unloading lines that are led past accommodation spaces, service spaces or control stations shall not be used for the transfer of products requiring a type 1G ship. Bow or stern loading and unloading lines shall not be used for the transfer of toxic products as specified in 1.2.53, where the design pressure is above 2.5 MPa.

3.8.3 Portable arrangements shall not be permitted.

3.8.4 Location of various openings

3.8.4.1 Entrances, air inlets and openings to accommodation spaces, service spaces, machinery spaces and controls stations, shall not face the cargo shore connection location of bow or stern loading and unloading arrangements. They shall be located on the outboard side of the superstructure or deckhouse at a distance of at least 4% of the length of the ship, but not less than 3 m from the end of the superstructure or deckhouse facing the cargo shore connection location of the bow or stern loading and unloading arrangements. This distance need not exceed 5 m.

3.8.4.2 Windows and sidescuttles facing the shore connection location and on the sides of the superstructure or deckhouse within the distance mentioned above shall be of the fixed (non-opening) type.

3.8.4.3 (...)

3.8.4.4 Where, in the case of small ships, compliance with 3.2.4.1 to 3.2.4.4 and 3.8.4.1 to 3.8.4.3 is not possible, the Administration may approve relaxations from the above requirements.

3.8.5 (...)

3.8.6 Firefighting arrangements for the bow or stern loading and unloading areas shall be in accordance with 11.3.1.4 and 11.4.6.

3.8.7 Means of communication between the cargo control station and the shore connection location shall be provided and, where applicable, certified for use in hazardous areas.

CHAPTER 4

(IGC Code Chapter 4)

Goal

To ensure the safe containment of cargo under all design and operating conditions having regard to the nature of the cargo carried. This will include measures to:

- .1 provide strength to withstand defined loads;
- .2 maintain the cargo in a liquid state;
- .3 design for or protect the hull structure from low temperature exposure; and
- .4 prevent the ingress of water or air into the cargo containment system.

Note:

IACS UR G1 *Vessels with cargo containment system for liquefied gas* originally intended for gas tankers (original title *Cargo containments of gas tankers*) is now applicable to ships other than gas tankers and therefore has not been included in these Rules. Anyway requirements of UR G1 are in line with the below requirements.

4 CARGO CONTAINMENT**4.1 Definitions**

4.1.1 A **cold spot** is a part of the hull or thermal insulation surface where a localized temperature decrease occurs with respect to the allowable minimum temperature of the hull or of its adjacent hull structure, or to design capabilities of cargo pressure/temperature control systems required in Chapter 7.

4.1.2 **Design vapour pressure " P_0 "** is the maximum gauge pressure, at the top of the tank, to be used in the design of the tank.

4.1.3 **Design temperature** for selection of materials is the minimum temperature at which cargo may be loaded or transported in the cargo tanks.

4.1.4 **Independent tanks** are self-supporting tanks. They do not form part of the ship's hull and are not essential to the hull strength. There are three categories of independent tank, which are referred to in 4.21, 4.22 and 4.23.

4.1.5 **Membrane tanks** are non-self-supporting tanks that consist of a thin liquid and gastight layer (membrane) supported through insulation by the adjacent hull structure. Membrane tanks are covered in 4.24.

4.1.6 **Integral tanks** are tanks that form a structural part of the hull and are influenced in the same manner by the loads that stress the adjacent hull structure. Integral tanks are covered in 4.25.

4.1.7 **Semi-membrane tanks** are non-self-supporting tanks in the loaded condition and consist of a layer, parts of which are supported through insulation by the adjacent hull structure. Semi-membrane tanks are covered in 4.26.

4.1.8 In addition to the definitions in 1.2, the definitions given in this Chapter shall apply throughout these Rules (the Code).

4.2 Application

Unless otherwise specified in part E, the requirements of parts A to D shall apply to all types of tanks, including those covered in part F.

Part A

CARGO CONTAINMENT

4.3 Functional requirements

4.3.1 The design life of the cargo containment system shall not be less than the design life of the ship.

4.3.2 Cargo containment systems shall be designed for North Atlantic environmental conditions and relevant long-term sea state scatter diagrams for unrestricted navigation. Lesser environmental conditions, consistent with the expected usage, may be accepted by the Administration for cargo containment systems used exclusively for restricted navigation. Greater environmental conditions may be required for cargo containment systems operated in conditions more severe than the North Atlantic environment.

4.3.3 Cargo containment systems shall be designed with suitable safety margins:

- .1 to withstand, in the intact condition, the environmental conditions anticipated for the cargo containment system's design life and the loading conditions appropriate for them, which include full homogeneous and partial load conditions, partial filling within defined limits and ballast voyage loads; and
- .2 being appropriate for uncertainties in loads, structural modelling, fatigue, corrosion, thermal effects, material variability, ageing and construction tolerances.

4.3.4 The cargo containment system structural strength shall be assessed against failure modes, including but not limited to plastic deformation, buckling and fatigue. The specific design conditions which shall be considered for the design of each cargo containment system are given in 4.21 to 4.26. There are three main categories of design conditions:

- .1 Ultimate design conditions – the cargo containment system structure and its structural components shall withstand loads liable to occur during its construction, testing and anticipated use in service, without loss of structural integrity. The design shall take into account proper combinations of the following loads:
 - .1 internal pressure;
 - .2 external pressure;
 - .3 dynamic loads due to the motion of the ship;
 - .4 thermal loads;
 - .5 sloshing loads;
 - .6 loads corresponding to ship deflections;
 - .7 tank and cargo weight with the corresponding reaction in way of supports;
 - .8 insulation weight;
 - .9 loads in way of towers and other attachments; and
 - .10 test loads.
- .2 Fatigue design conditions – the cargo containment system structure and its structural components shall not fail under accumulated cyclic loading.
- .3 The cargo containment system shall meet the following criteria:
 - .1 Collision – the cargo containment system shall be protectively located in accordance with 2.4.1 and withstand the collision loads specified in 4.15.1 without deformation of the supports, or the tank structure in way of the supports, likely to endanger the tank structure.
 - .2 Fire – the cargo containment systems shall sustain, without rupture, the rise in internal pressure specified in 8.4.1 under the fire scenarios envisaged therein.

- .3 Flooded compartment causing buoyancy on tank – the anti-flotation arrangements shall sustain the upward force, specified in 4.15.2, and there shall be no endangering plastic deformation to the hull.

4.3.5 Measures shall be applied to ensure that scantlings required meet the structural strength provisions and be maintained throughout the design life. Measures may include, but are not limited to, material selection, coatings, corrosion additions, cathodic protection and inerting. Corrosion allowance need not be required in addition to the thickness resulting from the structural analysis. However, where there is no environmental control, such as inerting around the cargo tank, or where the cargo is of a corrosive nature, the Administration or recognized organization acting on its behalf may require a suitable corrosion allowance.

4.3.6 An inspection/survey plan for the cargo containment system shall be developed and approved by the Administration or recognized organization acting on its behalf. The inspection/survey plan shall identify areas that need inspection during surveys throughout the cargo containment system's life and, in particular, all necessary in-service survey and maintenance that was assumed when selecting cargo containment system design parameters. Cargo containment systems shall be designed, constructed and equipped to provide adequate means of access to areas that need inspection as specified in the inspection/survey plan. Cargo containment systems, including all associated internal equipment, shall be designed and built to ensure safety during operations, inspection and maintenance (see 3.5).

4.4 Cargo containment safety principles

4.4.1 The containment systems shall be provided with a full secondary liquid-tight barrier capable of safely containing all potential leakages through the primary barrier and, in conjunction with the thermal insulation system, of preventing lowering of the temperature of the ship structure to an unsafe level.

4.4.2 However, the size and configuration or arrangement of the secondary barrier may be reduced where an equivalent level of safety is demonstrated in accordance with the requirements of 4.4.3 to 4.4.5, as applicable.

4.4.3 Cargo containment systems for which the probability for structural failures to develop into a critical state has been determined to be extremely low, but where the possibility of leakages through the primary barrier cannot be excluded, shall be equipped with a partial secondary barrier and small leak protection system capable of safely handling and disposing of the leakages. The arrangements shall comply with the following requirements:

- .1 failure developments that can be reliably detected before reaching a critical state (e.g. by gas detection or inspection) shall have a sufficiently long development time for remedial actions to be taken; and
- .2 failure developments that cannot be safely detected before reaching a critical state shall have a predicted development time that is much longer than the expected lifetime of the tank.

4.4.4 No secondary barrier is required for cargo containment systems, e.g. type C independent tanks, where the probability for structural failures and leakages through the primary barrier is extremely low and can be neglected.

4.4.5 No secondary barrier is required where the cargo temperature at atmospheric pressure is at or above -10°C.

4.5 Secondary barriers in relation to tank types

Secondary barriers in relation to the tank types defined in 4.21 to 4.26 shall be provided in accordance with the following table.

Cargo temperature at atmospheric pressure	-10°C and above	Below -10°C down to -55°C	Below -55°C
Basic tank type	No secondary barrier required	Hull may act as secondary barrier	Separate secondary barrier where required
Integral Membrane Semi-membrane Independent: • type A • type B • type C		Tank type not normally allowed ¹ Complete secondary barrier Complete secondary barrier ² Complete secondary barrier Partial secondary barrier No secondary barrier required	
<p>Note 1: A complete secondary barrier shall normally be required if cargoes with a temperature at atmospheric pressure below -10°C are permitted in accordance with 4.25.1.</p> <p>Note 2: In the case of semi-membrane tanks that comply in all respects with the requirements applicable to type B independent tanks, except for the manner of support, the Administration may, after special consideration, accept a partial secondary barrier.</p>			

4.6 Design of secondary barriers

4.6.1 Where the cargo temperature at atmospheric pressure is not below -55°C, the hull structure may act as a secondary barrier based on the following:

- .1 the hull material shall be suitable for the cargo temperature at atmospheric pressure as required by 4.19.1.4; and
- .2 the design shall be such that this temperature will not result in unacceptable hull stresses.

4.6.2 The design of the secondary barrier shall be such that:

- .1 it is capable of containing any envisaged leakage of liquid cargo for a period of 15 days, unless different criteria apply for particular voyages, taking into account the load spectrum referred to in 4.18.2.6;
- .2 physical, mechanical, or operational events within the cargo tank that could cause failure of the primary barrier shall not impair the due function of the secondary barrier, or vice versa;
- .3 failure of a support or an attachment to the hull structure will not lead to loss of liquid tightness of both the primary and secondary barriers;
- .4 it is capable of being periodically checked for its effectiveness by means acceptable to the Administration or recognized organization acting on its behalf. This may be by means of a visual inspection or a pressure/vacuum test or other suitable means carried out according to a documented procedure agreed with the Administration or the recognized organization acting on its behalf;

IACS interpretation

Secondary barrier testing requirements

For containment systems with glued secondary barriers:

- *At the time of construction, a tightness test should be carried out in accordance with approved system designers' procedures and acceptance criteria before and after initial cool down. Low differential pressures tests are not considered an acceptable test.*
- *If the designer's threshold values are exceeded an investigation is to be carried out and additional testing such as thermographic or acoustic emissions testing should be carried out.*

– *The values recorded should be used as reference for future assessment of secondary barrier tightness.*

For containment systems with welded metallic secondary barriers, a tightness test after initial cool down is not required. (IACS UI GC12)

- .5** the methods required in .4 above shall be approved by the Administration or recognized organization acting on its behalf and shall include, where applicable to the test procedure:
- .1** details on the size of defect acceptable and the location within the secondary barrier, before its liquid-tight effectiveness is compromised;
 - .2** accuracy and range of values of the proposed method for detecting defects in .1 above;
 - .3** scaling factors to be used in determining the acceptance criteria, if full scale model testing is not undertaken; and
 - .4** effects of thermal and mechanical cyclic loading on the effectiveness of the proposed test; and
- .6** the secondary barrier shall fulfil its functional requirements at a static angle of heel of 30°.

4.7 Partial secondary barriers and primary barrier small leak protection system

4.7.1 Partial secondary barriers as permitted in 4.4.3 shall be used with a small leak protection system and meet all the requirements in 4.6.2. The small leak protection system shall include means to detect a leak in the primary barrier, provision such as a spray shield to deflect any liquid cargo down into the partial secondary barrier, and means to dispose of the liquid, which may be by natural evaporation.

4.7.2 The capacity of the partial secondary barrier shall be determined, based on the cargo leakage corresponding to the extent of failure resulting from the load spectrum referred to in 4.18.2.6, after the initial detection of a primary leak. Due account may be taken of liquid evaporation, rate of leakage, pumping capacity and other relevant factors.

4.7.3 The required liquid leakage detection may be by means of liquid sensors, or by an effective use of pressure, temperature or gas detection systems, or any combination thereof.

4.8 Supporting arrangements

4.8.1 The cargo tanks shall be supported by the hull in a manner that prevents bodily movement of the tank under the static and dynamic loads defined in 4.12 to 4.15, where applicable, while allowing contraction and expansion of the tank under temperature variations and hull deflections without undue stressing of the tank and the hull.

4.8.2 Anti-flotation arrangements shall be provided for independent tanks and capable of withstanding the loads defined in 4.15.2 without plastic deformation likely to endanger the hull structure.

4.8.3 Supports and supporting arrangements shall withstand the loads defined in 4.13.9 and 4.15, but these loads need not be combined with each other or with wave-induced loads.

4.9 Associated structure and equipment

4.9.1 Cargo containment systems shall be designed for the loads imposed by associated structure and equipment. This includes pump towers, cargo domes, cargo pumps and piping, stripping pumps and piping, nitrogen piping, access hatches, ladders, piping penetrations, liquid level gauges, independent level alarm gauges, spray nozzles, and instrumentation systems (such as pressure, temperature and strain gauges).

4.10 Thermal insulation

4.10.1 Thermal insulation shall be provided, as required, to protect the hull from temperatures below those allowable (see 4.19.1) and limit the heat flux into the tank to the levels that can be maintained by the pressure and temperature control system applied in Chapter 7.

4.10.2 In determining the insulation performance, due regard shall be given to the amount of the acceptable boil-off in association with the reliquefaction plant on board, main propulsion machinery or other temperature control system.

Part B

DESIGN LOADS

4.11 General

This section defines the design loads to be considered with regard to the requirements in 4.16, 4.17 and 4.18. This includes:

- .1 load categories (permanent, functional, environmental and accidental) and the description of the loads;
- .2 the extent to which these loads shall be considered depending on the type of tank, and is more fully detailed in the following paragraphs; and
- .3 tanks, together with their supporting structure and other fixtures, that shall be designed taking into account relevant combinations of the loads described below.

4.12 Permanent loads

4.12.1 Gravity loads

The weight of tank, thermal insulation, loads caused by towers and other attachments shall be considered.

4.12.2 Permanent external loads

Gravity loads of structures and equipment acting externally on the tank shall be considered.

4.13 Functional loads

4.13.1 Loads arising from the operational use of the tank system shall be classified as functional loads. All functional loads that are essential for ensuring the integrity of the tank system, during all design conditions, shall be considered. As a minimum, the effects from the following criteria, as applicable, shall be considered when establishing functional loads:

- .1 internal pressure;
- .2 external pressure;
- .3 thermally induced loads;
- .4 vibration;
- .5 interaction loads;
- .6 loads associated with construction and installation;
- .7 test loads;
- .8 static heel loads; and
- .9 weight of cargo.

4.13.2 Internal pressure

- .1 In all cases, including 4.13.2.2, P_o shall not be less than MARVS.

- .2 For cargo tanks, where there is no temperature control and where the pressure of the cargo is dictated only by the ambient temperature, P_o shall not be less than the gauge vapour pressure of the cargo at a temperature of 45°C except as follows:
 - .1 lower values of ambient temperature may be accepted by the Administration or recognized organization acting on its behalf for ships operating in restricted areas. Conversely, higher values of ambient temperature may be required; and
 - .2 for ships on voyages of restricted duration, P_o may be calculated based on the actual pressure rise during the voyage, and account may be taken of any thermal insulation of the tank.
- .3 Subject to special consideration by the Administration and to the limitations given in 4.21 to 4.26, for the various tank types, a vapour pressure P_h higher than P_o may be accepted for site specific conditions (harbour or other locations), where dynamic loads are reduced. Any relief valve setting resulting from this paragraph shall be recorded in the *International Certificate of Fitness for the Carriage of Liquefied Gases in Bulk*.
- .4 The internal pressure P_{eq} results from the vapour pressure P_o or P_h plus the maximum associated dynamic liquid pressure P_{gd} , but not including the effects of liquid sloshing loads. Guidance formulae for associated dynamic liquid pressure P_{gd} are given in 4.28.1.

4.13.3 External pressure

External design pressure loads shall be based on the difference between the minimum internal pressure and the maximum external pressure to which any portion of the tank may be simultaneously subjected.

4.13.4 Thermally induced loads

4.13.4.1 Transient thermally induced loads during cooling down periods shall be considered for tanks intended for cargo temperatures below -55°C.

4.13.4.2 Stationary thermally induced loads shall be considered for cargo containment systems where the design supporting arrangements or attachments and operating temperature may give rise to significant thermal stresses (see 7.2).

4.13.5 Vibration

The potentially damaging effects of vibration on the cargo containment system shall be considered.

4.13.6 Interaction loads

The static component of loads resulting from interaction between cargo containment system and the hull structure, as well as loads from associated structure and equipment, shall be considered.

4.13.7 Loads associated with construction and installation

Loads or conditions associated with construction and installation, e.g. lifting, shall be considered.

4.13.8 Test loads

Account shall be taken of the loads corresponding to the testing of the cargo containment system referred to in 4.21 to 4.26.

4.13.9 Static heel loads

Loads corresponding to the most unfavourable static heel angle within the range 0° to 30° shall be considered.

4.13.10 Other loads

Any other loads not specifically addressed, which could have an effect on the cargo containment system, shall be taken into account.

4.14 Environmental loads

Environmental loads are defined as those loads on the cargo containment system that are caused by the surrounding environment and that are not otherwise classified as a permanent, functional or accidental load.

4.14.1 Loads due to ship motion

4.14.1.1 The determination of dynamic loads shall take into account the long-term distribution of ship motion in irregular seas, which the ship will experience during its operating life. Account may be taken of the reduction in dynamic loads due to necessary speed reduction and variation of heading.

4.14.1.2 The ship's motion shall include surge, sway, heave, roll, pitch and yaw. The accelerations acting on tanks shall be estimated at their centre of gravity and include the following components:

- .1** vertical acceleration: motion accelerations of heave, pitch and, possibly, roll (normal to the ship base);
- .2** transverse acceleration: motion accelerations of sway, yaw and roll and gravity component of roll; and
- .3** longitudinal acceleration: motion accelerations of surge and pitch and gravity component of pitch.

4.14.1.3 Methods to predict accelerations due to ship motion shall be proposed and approved by the Administration or recognized organization acting on its behalf.

4.14.1.4 Guidance formulae for acceleration components are given in 4.28.2.

4.14.1.5 Ships for restricted service may be given special consideration.

4.14.2 Dynamic interaction loads

Account shall be taken of the dynamic component of loads resulting from interaction between cargo containment systems and the hull structure, including loads from associated structures and equipment.

4.14.3 Sloshing loads

4.14.3.1 The sloshing loads on a cargo containment system and internal components shall be evaluated based on allowable filling levels.

4.14.3.2 When significant sloshing-induced loads are expected to be present, special tests and calculations shall be required covering the full range of intended filling levels.

4.14.4 Snow and ice loads

Snow and icing shall be considered, if relevant.

4.14.5 Loads due to navigation in ice

Loads due to navigation in ice shall be considered for vessels intended for such service.

4.15 Accidental loads

Accidental loads are defined as loads that are imposed on a cargo containment system and its supporting arrangements under abnormal and unplanned conditions.

4.15.1 Collision loads

The collision load shall be determined based on the cargo containment system under fully loaded condition with an inertial force corresponding to $0.5 g$ in the forward direction and $0.25 g$ in the aft direction, where " g " is gravitational acceleration.

4.15.2 Loads due to flooding on ship

For independent tanks, loads caused by the buoyancy of an empty tank in a hold space flooded to the summer load draught shall be considered in the design of the anti-flotation chocks and the supporting hull structure.

Part C

STRUCTURAL INTEGRITY

4.16 General

4.16.1 The structural design shall ensure that tanks have an adequate capacity to sustain all relevant loads with an adequate margin of safety. This shall take into account the possibility of plastic deformation, buckling, fatigue and loss of liquid and gas tightness.

4.16.2 The structural integrity of cargo containment systems shall be demonstrated by compliance with 4.21 to 4.26, as appropriate, for the cargo containment system type.

4.16.3 The structural integrity of cargo containment system types that are of novel design and differ significantly from those covered by 4.21 to 4.26 shall be demonstrated by compliance with 4.27 to ensure that the overall level of safety provided in this Chapter is maintained.

4.17 Structural analyses

4.17.1 Analysis

4.17.1.1 The design analyses shall be based on accepted principles of statics, dynamics and strength of materials.

4.17.1.2 Simplified methods or simplified analyses may be used to calculate the load effects, provided that they are conservative. Model tests may be used in combination with, or instead of, theoretical calculations. In cases where theoretical methods are inadequate, model or full-scale tests may be required.

4.17.1.3 When determining responses to dynamic loads, the dynamic effect shall be taken into account where it may affect structural integrity.

4.17.2 Load scenarios

4.17.2.1 For each location or part of the cargo containment system to be considered and for each possible mode of failure to be analysed, all relevant combinations of loads that may act simultaneously shall be considered.

4.17.2.2 The most unfavourable scenarios for all relevant phases during construction, handling, testing and in service, and conditions shall be considered.

4.17.3 When the static and dynamic stresses are calculated separately, and unless other methods of calculation are justified, the total stresses shall be calculated according to:

$$\begin{aligned}\sigma_x &= \sigma_{x.st} \pm \sqrt{\sum (\sigma_{x.dyn})^2} \\ \sigma_y &= \sigma_{y.st} \pm \sqrt{\sum (\sigma_{y.dyn})^2} \\ \sigma_z &= \sigma_{z.st} \pm \sqrt{\sum (\sigma_{z.dyn})^2} \\ \tau_{xy} &= \tau_{xy.st} \pm \sqrt{\sum (\tau_{xy.dyn})^2} \\ \tau_{xz} &= \tau_{xz.st} \pm \sqrt{\sum (\tau_{xz.dyn})^2} \\ \tau_{yz} &= \tau_{yz.st} \pm \sqrt{\sum (\tau_{yz.dyn})^2}\end{aligned}$$

where:

$\sigma_{x.st}$, $\sigma_{y.st}$, $\sigma_{z.st}$, $\tau_{xy.st}$, $\tau_{xz.st}$ and $\tau_{yz.st}$ are static stresses; and
 $\sigma_{x.dyn}$, $\sigma_{y.dyn}$, $\sigma_{z.dyn}$, $\tau_{xy.dyn}$, $\tau_{xz.dyn}$ and $\tau_{yz.dyn}$ are dynamic stresses,

each shall be determined separately from acceleration components and hull strain components due to deflection and torsion.

4.18 Design conditions

All relevant failure modes shall be considered in the design for all relevant load scenarios and design conditions. The design conditions are given in the earlier part of this Chapter, and the load scenarios are covered by 4.17.2.

4.18.1 Ultimate design condition

Structural capacity may be determined by testing, or by analysis, taking into account both the elastic and plastic material properties, by simplified linear elastic analysis or by these *Rules* (the Code) provisions.

4.18.1.1 Plastic deformation and buckling shall be considered.

4.18.1.2 Analysis shall be based on characteristic load values as follows:

Permanent loads: Expected values

Functional loads: Specified values

Environmental loads: For wave loads: most probable largest load encountered during 10^8 wave encounters.

4.18.1.3 For the purpose of ultimate strength assessment, the following material parameters apply:

- .1.1** R_e = specified minimum yield stress at room temperature (N/mm²). If the stress-strain curve does not show a defined yield stress, the 0.2% proof stress applies.
- .1.2** R_m = specified minimum tensile strength at room temperature (N/mm²).

For welded connections where under-matched welds, i.e. where the weld metal has lower tensile strength than the parent metal, are unavoidable, such as in some aluminium alloys, the respective R_e and R_m of the welds, after any applied heat treatment, shall be used. In such cases, the transverse weld tensile strength shall not be less than the actual yield strength of the parent metal. If this cannot be achieved, welded structures made from such materials shall not be incorporated in cargo containment systems.

- .2** The above properties shall correspond to the minimum specified mechanical properties of the material, including the weld metal in the as-fabricated condition. Subject to special consideration by the Administration or recognized organization acting on its behalf, account may be taken of the enhanced yield stress and tensile strength at low temperature. The temperature on which the material properties are based shall be shown on the *International Certificate of Fitness for the Carriage of Liquefied Gases in Bulk* required in 1.4.

4.18.1.4 The equivalent stress σ_c (von Mises, Huber) shall be determined by:

$$\sigma_c = \sqrt{\sigma_x^2 + \sigma_y^2 + \sigma_z^2 - \sigma_x\sigma_y - \sigma_x\sigma_z - \sigma_y\sigma_z + 3(\tau_{xy}^2 + \tau_{xz}^2 + \tau_{yz}^2)}$$

where:

- σ_x = total normal stress in x-direction;
- σ_y = total normal stress in y-direction;
- σ_z = total normal stress in z-direction;
- τ_{xy} = total shear stress in x-y plane;
- τ_{xz} = total shear stress in x-z plane;
- τ_{yz} = total shear stress in y-z plane.

The above values shall be calculated as described in 4.17.3.

4.18.1.5 Allowable stresses for materials other than those covered by Chapter 6 shall be subject to approval by the Administration or recognized organization acting on its behalf in each case.

4.18.1.6 Stresses may be further limited by fatigue analysis, crack propagation analysis and buckling criteria.

4.18.2 Fatigue design condition

4.18.2.1 The fatigue design condition is the design condition with respect to accumulated cyclic loading.

4.18.2.2 Where a fatigue analysis is required, the cumulative effect of the fatigue load shall comply with:

$$\sum \frac{n_i}{N_i} + \frac{n_{Loading}}{N_{Loading}} \leq C_w$$

where:

- n_i = number of stress cycles at each stress level during the life of the tank;
- N_i = number of cycles to fracture for the respective stress level according to the Wohler (S-N) curve;
- $n_{Loading}$ = number of loading and unloading cycles during the life of the tank, not to be less than 1000⁶. Loading and unloading cycles include a complete pressure and thermal cycle;
- $N_{Loading}$ = number of cycles to fracture for the fatigue loads due to loading and unloading; and
- C_w = maximum allowable cumulative fatigue damage ratio.

⁶ 1000 cycles normally corresponds to 20 years of operation.

The fatigue damage shall be based on the design life of the tank but not less than 10^8 wave encounters.

4.18.2.3 Where required, the cargo containment system shall be subject to fatigue analysis, considering all fatigue loads and their appropriate combinations for the expected life of the cargo containment system. Consideration shall be given to various filling conditions.

4.18.2.4 S-N curves

4.18.2.4.1 Design S-N curves used in the analysis shall be applicable to the materials and weldments, construction details, fabrication procedures and applicable state of the stress envisioned.

4.18.2.4.2 The S-N curves shall be based on a 97.6% probability of survival corresponding to the mean-minus-two-standard-deviation curves of relevant experimental data up to final failure. Use of S-N curves derived in a different way requires adjustments to the acceptable C_w values specified in 4.18.2.7 to 4.18.2.9.

4.18.2.5 Analysis shall be based on characteristic load values as follows:

Permanent loads: Expected values

Functional loads: Specified values or specified history

Environmental loads: Expected load history, but not less than 10^8 cycles.

If simplified dynamic loading spectra are used for the estimation of the fatigue life, they shall be specially considered by the Administration or recognized organization acting on its behalf.

4.18.2.6 Fatigue crack analysis

4.18.2.6.1 Where the size of the secondary barrier is reduced, as is provided for in 4.4.3, fracture mechanics analyses of fatigue crack growth shall be carried out to determine:

- .1 crack propagation paths in the structure;
- .2 crack growth rate;
- .3 the time required for a crack to propagate to cause a leakage from the tank;
- .4 the size and shape of through thickness cracks; and
- .5 the time required for detectable cracks to reach a critical state.

The fracture mechanics are, in general, based on crack growth data taken as a mean value plus two standard deviations of the test data.

4.18.2.6.2 In analysing crack propagation, the largest initial crack not detectable by the inspection method applied shall be assumed, taking into account the allowable non-destructive testing and visual inspection criterion, as applicable.

4.18.2.6.3 Crack propagation analysis under the condition specified in 4.18.2.7: the simplified load distribution and sequence over a period of 15 days may be used. Such distributions may be obtained as indicated in figure 4.4. Load distribution and sequence for longer periods, such as in 4.18.2.8 and 4.18.2.9 shall be approved by the Administration or recognized organization acting on its behalf.

4.18.2.6.4 The arrangements shall comply with 4.18.2.7 to 4.18.2.9, as applicable.

4.18.2.7 For failures that can be reliably detected by means of leakage detection:

C_w shall be less than or equal to 0.5.

Predicted remaining failure development time, from the point of detection of leakage till reaching a critical state, shall not be less than 15 days, unless different requirements apply for ships engaged in particular voyages.

4.18.2.8 For failures that cannot be detected by leakage but that can be reliably detected at the time of in-service inspections:

C_w shall be less than or equal to 0.5.

Predicted remaining failure development time, from the largest crack not detectable by in-service inspection methods until reaching a critical state, shall not be less than three times the inspection interval.

4.18.2.9 In particular locations of the tank, where effective defect or crack development detection cannot be assured, the following, more stringent, fatigue acceptance criteria shall be applied as a minimum:

C_w shall be less than or equal to 0.1.

Predicted failure development time, from the assumed initial defect until reaching a critical state, shall not be less than three times the lifetime of the tank.

4.18.3 Accident design condition

4.18.3.1 The accident design condition is a design condition for accidental loads with extremely low probability of occurrence.

4.18.3.2 Analysis shall be based on the characteristic values as follows:

Permanent loads: Expected values

Functional loads: Specified values

Environmental loads: Specified values

Accidental loads: Specified values or expected values

4.18.3.3 Loads mentioned in 4.13.9 and 4.15 need not be combined with each other or with wave-induced loads.

Part D

MATERIALS AND CONSTRUCTION

4.19 Materials

Goal

To ensure that the cargo containment system, primary and secondary barriers, the thermal insulation, adjacent ship structure and other materials in the cargo containment system are constructed from materials of suitable properties for the conditions they will experience, both in normal service and in the event of failure of the primary barrier, where applicable.

Notes:

1. For the application of high manganese austenitic steel – see MSC.1/Circ.1599/Rev.3 of 2024-07-01 *Revised guidelines on the application of high manganese austenitic steel for cryogenic service.*

2. For the acceptance of alternative metallic materials – see MSC.1/Circ.1622/Rev.1 of 2024-07-01 *Guidelines for the acceptance of alternative metallic materials for cryogenic service in ships carrying liquefied gases in bulk and ships using gases or other low-flashpoint fuels*.

4.19.1 Materials forming ship structure

4.19.1.1 To determine the grade of plate and sections used in the hull structure, a temperature calculation shall be performed for all tank types when the cargo temperature is below -10°C. The following assumptions shall be made in this calculation:

- .1 the primary barrier of all tanks shall be assumed to be at the cargo temperature;
- .2 in addition to .1, where a complete or partial secondary barrier is required, it shall be assumed to be at the cargo temperature at atmospheric pressure for any one tank only;
- .3 for worldwide service, ambient temperatures shall be taken as 5°C for air and 0°C for seawater. Higher values may be accepted for ships operating in restricted areas and, conversely, lower values may be fixed by the Administration for ships trading to areas where lower temperatures are expected during the winter months;
- .4 still air and seawater conditions shall be assumed, i.e. no adjustment for forced convection;
- .5 degradation of the thermal insulation properties over the life of the ship due to factors such as thermal and mechanical ageing, compaction, ship motions and tank vibrations, as defined in 4.19.3.6 and 4.19.3.7, shall be assumed;
- .6 the cooling effect of the rising boil-off vapour from the leaked cargo shall be taken into account, where applicable;
- .7 credit for hull heating may be taken in accordance with 4.19.1.5, provided the heating arrangements are in compliance with 4.19.1.6;
- .8 no credit shall be given for any means of heating, except as described in 4.19.1.5; and
- .9 for members connecting inner and outer hulls, the mean temperature may be taken for determining the steel grade.

The ambient temperatures used in the design, described in this paragraph, shall be shown on the *International Certificate of Fitness for the Carriage of Liquefied Gases in Bulk* required in 1.4.4.

4.19.1.2 The shell and deck plating of the ship and all stiffeners attached thereto shall be in accordance with recognized standards. If the calculated temperature of the material in the design condition is below -5°C due to the influence of the cargo temperature, the material shall be in accordance with table 6.5.

4.19.1.3 The materials of all other hull structures for which the calculated temperature in the design condition is below 0°C, due to the influence of cargo temperature and that do not form the secondary barrier, shall also be in accordance with table 6.5. This includes hull structure supporting the cargo tanks, inner bottom plating, longitudinal bulkhead plating, transverse bulkhead plating, floors, webs, stringers and all attached stiffening members.

4.19.1.4 The hull material forming the secondary barrier shall be in accordance with table 6.2. Where the secondary barrier is formed by the deck or side shell plating, the material grade required by table 6.2 shall be carried into the adjacent deck or side shell plating, where applicable, to a suitable extent.

4.19.1.5 Means of heating structural materials may be used to ensure that the material temperature does not fall below the minimum allowed for the grade of material specified in table 6.5. In the calculations required in 4.19.1.1, credit for such heating may be taken in accordance with the following:

- .1 for any transverse hull structure;

- .2 for longitudinal hull structure referred to in 4.19.1.2 and 4.19.1.3 where colder ambient temperatures are specified, provided the material remains suitable for the ambient temperature conditions of +5°C for air and 0°C for seawater with no credit taken in the calculations for heating; and
- .3 as an alternative to .2, for longitudinal bulkhead between cargo tanks, credit may be taken for heating, provided the material remain suitable for a minimum design temperature of -30°C, or a temperature 30°C lower than that determined by 4.19.1.1 with the heating considered, whichever is less. In this case, the ship's longitudinal strength shall comply with SOLAS regulation II-1/3-1 for both when those bulkhead(s) are considered effective and not.

4.19.1.6 The means of heating referred to in 4.19.1.5 shall comply with the following requirements:

- .1 the heating system shall be arranged so that, in the event of failure in any part of the system, standby heating can be maintained equal to not less than 100% of the theoretical heat requirement;

IACS and IMO interpretation

Cargo tank structure heating arrangement power supply

1. *Heating system referred to in 4.19.1.6.1 is to be such that in case of a single failure of a mechanical or electrical component in any part of the system, heating can be maintained at not less than 100% of the theoretical heat requirement.*
 2. *Where the above requirements are met by duplication of the system components, i.e., heaters, glycol circulation pumps, electrical control panel, auxiliary boilers etc., all electrical components of at least one of the systems are to be supplied from the emergency source of electrical power.*
 3. *Where duplication of the primary source of heat, e.g., oil-fired boiler is not feasible, alternative proposals can be accepted such as an electric heater capable of providing 100% of the theoretical heat requirement provided and supplied by an individual circuit arranged separately on the emergency switchboard. Other solutions may be considered towards satisfying the requirements of 4.19.1.6.1 provided a suitable risk assessment is conducted to the satisfaction of the Administration. The requirement in paragraph 2 of this interpretation continues to apply to all other electrical components in the system. (IACS UI GC23, MSC.1/Circ.1606)*
- .2 the heating system shall be considered as an essential auxiliary. All electrical components of at least one of the systems provided in accordance with 4.19.1.5.1 shall be supplied from the emergency source of electrical power; and
 - .3 the design and construction of the heating system shall be included in the approval of the containment system by the Administration or recognized organization acting on its behalf.

4.19.2 *Materials of primary and secondary barriers*

4.19.2.1 Metallic materials used in the construction of primary and secondary barriers not forming the hull, shall be suitable for the design loads that they may be subjected to, and be in accordance with, table 6.1, 6.2 or 6.3.

4.19.2.2 Materials, either non-metallic or metallic but not covered by tables 6.1, 6.2 and 6.3, used in the primary and secondary barriers may be approved by the Administration or recognized organization acting on its behalf, considering the design loads that they may be subjected to, their properties and their intended use.

4.19.2.3 Where non-metallic materials, including composites, are used for, or incorporated in the primary or secondary barriers, they shall be tested for the following properties, as applicable, to ensure that they are adequate for the intended service:

- .1 compatibility with the cargoes;

- .2 ageing;
- .3 mechanical properties;
- .4 thermal expansion and contraction;
- .5 abrasion;
- .6 cohesion;
- .7 resistance to vibrations;
- .8 resistance to fire and flame spread; and
- .9 resistance to fatigue failure and crack propagation.

4.19.2.4 The above properties, where applicable, shall be tested for the range between the expected maximum temperature in service and +5°C below the minimum design temperature, but not lower than -196°C.

4.19.2.5 Where non-metallic materials, including composites, are used for the primary and secondary barriers, the joining processes shall also be tested as described above.

4.19.2.6 Guidance on the use of non-metallic materials in the construction of primary and secondary barriers is provided in Appendix 4.

4.19.2.7 Consideration may be given to the use of materials in the primary and secondary barrier, which are not resistant to fire and flame spread, provided they are protected by a suitable system such as a permanent inert gas environment, or are provided with a fire-retardant barrier.

4.19.3 Thermal insulation and other materials used in cargo containment systems

4.19.3.1 Load-bearing thermal insulation and other materials used in cargo containment systems shall be suitable for the design loads.

4.19.3.2 Thermal insulation and other materials used in cargo containment systems shall have the following properties, as applicable, to ensure that they are adequate for the intended service:

- .1 compatibility with the cargoes;
- .2 solubility in the cargo;
- .3 absorption of the cargo;
- .4 shrinkage;
- .5 ageing;
- .6 closed cell content;
- .7 density;
- .8 mechanical properties, to the extent that they are subjected to cargo and other loading effects, thermal expansion and contraction;
- .9 abrasion;
- .10 cohesion;
- .11 thermal conductivity;
- .12 resistance to vibrations;
- .13 resistance to fire and flame spread; and
- .14 resistance to fatigue failure and crack propagation.

4.19.3.3 The above properties, where applicable, shall be tested for the range between the expected maximum temperature in service and 5°C below the minimum design temperature, but not lower than -196°C.

4.19.3.4 Due to location or environmental conditions, thermal insulation materials shall have suitable properties of resistance to fire and flame spread and shall be adequately protected against penetration of water vapour and mechanical damage. Where the thermal insulation is

located on or above the exposed deck, and in way of tank cover penetrations, it shall have suitable fire resistance properties in accordance with recognized standards or be covered with a material having low flame-spread characteristics and forming an efficient approved vapour seal.

4.19.3.5 Thermal insulation that does not meet recognized standards for fire resistance may be used in hold spaces that are not kept permanently inerted, provided its surfaces are covered with material with low flame-spread characteristics and that forms an efficient approved vapour seal.

4.19.3.6 Testing for thermal conductivity of thermal insulation shall be carried out on suitably aged samples.

4.19.3.7 Where powder or granulated thermal insulation is used, measures shall be taken to reduce compaction in service and to maintain the required thermal conductivity and also prevent any undue increase of pressure on the cargo containment system.

4.20 Construction processes

Goal

To define suitable construction processes and test procedures in order to ensure, as far as reasonably practical, that the cargo containment system will perform satisfactorily in service in accordance with the assumptions made at the design stage.

4.20.1 Weld joint design

4.20.1.1 All welded joints of the shells of independent tanks shall be of the in-plane butt weld full penetration type. For dome-to-shell connections only, tee welds of the full penetration type may be used depending on the results of the tests carried out at the approval of the welding procedure. Except for small penetrations on domes, nozzle welds shall also be designed with full penetration.

IACS and IMO interpretation

Tee welds in type A or type B independent tanks

The regulation 4.20.1.1 is applicable to independent tanks of type A or type B, primarily constructed of plane surfaces. This includes the tank corners which are constructed using bent plating which is aligned with the tank surfaces and connected with in-plane welds.

The applicability of the expression "For dome-to-shell connections only" is clarified as follows:

- *Welded corners (i.e. corners made of weld metal) shall not be used in the main tank shell construction, i.e. corners between shell side (sloped plane surfaces parallel to hopper or top side inclusive if any) and bottom or top of the tank, and between tank end transverse bulkheads and bottom, top or shell sides (sloped plane surfaces inclusive if any) of the tank. Instead, tank corners which are constructed using bent plating aligned with the tank surfaces and connected with in-plane welds are to be used.*
- *Tee welds can be accepted for other localised constructions of the shell such as suction well, sump, dome, etc. where tee welds of full penetration type shall also be used. (IACS UI GC20, MSC.1/Circ.1625)*

4.20.1.2 Welding joint details for type C independent tanks, and for the liquid-tight primary barriers of type B independent tanks primarily constructed of curved surfaces, shall be as follows:

- .1** all longitudinal and circumferential joints shall be of butt welded, full penetration, double vee or single vee type. Full penetration butt welds shall be obtained by double welding or by the use of backing rings. If used, backing rings shall be removed except from very small process pressure vessels. Other edge preparations may be permitted, depending on the results of the tests carried out at the approval of the welding procedure; and

- .2 the bevel preparation of the joints between the tank body and domes and between domes and relevant fittings shall be designed according to a standard acceptable to the Administration or recognized organization acting on its behalf. All welds connecting nozzles, domes or other penetrations of the vessel and all welds connecting flanges to the vessel or nozzles shall be full penetration welds.

IACS and IMO interpretation

Welds of type C independent bi-lobe tank with centreline bulkhead

The regulation 4.20.1.2 is applicable to type C independent tanks including bi-lobe tanks, primarily constructed of curved surfaces fitted with a centreline bulkhead.

The applicability of the expression "Other edge preparations" is clarified as follows:

- *Cruciform full penetration welded joints in a bi-lobe tank with centreline bulkhead can be accepted for the tank structure construction at tank centreline welds with bevel preparation subject to the approval of the Administration or recognised organisation acting on its behalf, based on the results of the tests carried out at the approval of the welding procedure. (See below example)*

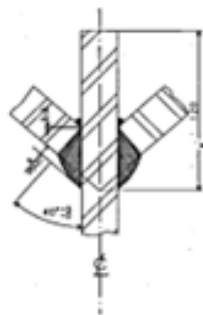

(IACS UI GC21, MSC.1/Circ.1625)

4.20.1.3 Where applicable, all the construction processes and testing, except that specified in 4.20.3, shall be done in accordance with the applicable provisions of Chapter 6.

4.20.2 Design for gluing and other joining processes

The design of the joint to be glued (or joined by some other process except welding) shall take account of the strength characteristics of the joining process.

4.20.3 Testing

4.20.3.1 All cargo tanks and process pressure vessels shall be subjected to hydrostatic or hydropneumatic pressure testing in accordance with 4.21 to 4.26, as applicable for the tank type.

4.20.3.2 All tanks shall be subject to a tightness test which may be performed in combination with the pressure test referred to in 4.20.3.1.

4.20.3.3 Requirements with respect to inspection of secondary barriers shall be decided by the Administration or recognized organization acting on its behalf in each case, taking into account the accessibility of the barrier (see 4.6.2).

4.20.3.4 The Administration may require that for ships fitted with novel type B independent tanks, or tanks designed according to 4.27 at least one prototype tank and its supporting structures shall be instrumented with strain gauges or other suitable equipment to confirm stress levels. Similar instrumentation may be required for type C independent tanks, depending on their configuration and on the arrangement of their supports and attachments.

4.20.3.5 The overall performance of the cargo containment system shall be verified for compliance with the design parameters during the first full loading and discharging of the cargo, in accordance with the survey procedure and requirements in 1.4 and the requirements of the Administration or recognized organization acting on its behalf. Records of the performance of the components and equipment essential to verify the design parameters, shall be maintained and be available to the Administration.

IACS interpretation

NOTE: This interpretation applies to 4.20.3.5, 4.20.3.6, 4.20.3.7, 5.13.2.5 and 13.3.5.

Verifications before and after the first loaded voyage

Application

This UI applies to all vessels carrying liquefied gases in bulk.

Certification

The following initial certificates shall be “conditionally” issued at delivery subject to satisfactory completion of all required verifications and examinations, as applicable:

1. Classification Certificate
2. International Certificate of Fitness for the Carriage of Liquefied Gases in Bulk

Note: *The conditions may either be stated on the Classification Certificate or issued as a Condition of Class -in the ship's Record.*

Survey Requirements

Surveyor attendance is required at the first cargo loading and first cargo unloading.

*Surveyor attendance during new building gas trials can be considered to comply with the below applicable verifications and examinations survey requirements, with the exceptions of the survey requirements marked (**).¹*

Note 1: *The symbol (**) indicates survey requirements only feasible to be carried out at the time of first full cargo loading/unloading.*

Verifications and examinations at gas trials or first full cargo loading, as applicable to cargo containment system

Note: *When attending at first full cargo loading, priority shall be given to latter stages of loading;*

- *verify the satisfactory functionality of the emergency shutdown system during testing;*
- *satisfactory operation of gas detection system;*
- *satisfactory operation of cargo tank pressure monitoring system;*
- *satisfactory operation of inter barrier space(s) and insulation space(s) pressure monitoring system, as applicable;*
- *satisfactory operation of cargo tank temperature monitoring system;*
- *satisfactory operation of cargo tank level indicating system;*
- *satisfactory operation of inter barrier space(s) and inner hull temperature monitoring system, as applicable;*
- *inert gas generator, if operating;*
- *nitrogen generating plant, if operating;*
- *nitrogen pressure control system for insulation, inter-barrier, and annular spaces, as applicable;*
- *reliquefaction plant, if fitted;*
- *equipment fitted for the burning of cargo vapours such as boilers, engines, gas combustion units, etc., if operating;*
- *examination of on-deck cargo piping systems including expansion and supporting arrangements;*
- *verification and examination of all piping systems, including valves, fittings and associated equipment for handling cargo or vapours;²*

Note 2: *Each Classification Society is to ensure that any additional verifications are required to meet own Classification requirements.*

- *advise Master to carry out cold spot examination of the hull and external insulation during transit voyage to unloading port and record in ship's logbook; and*
- *advise Master to test high-level alarm(s) with liquid cargo during voyage and record in ship's logbook, when loading condition permits.*

Verifications and examinations at gas trials or first full cargo unloading, as applicable

Note: *When attending at first full cargo unloading, priority shall be given to the commencement of unloading.*

- *examination of on-deck cargo piping systems including expansion and supporting arrangements;*
- *review logbook entry of emergency shutdown system testing prior to commencement of unloading;*
- *(**) review cargo logs and alarm reports for cargo tank pressure, temperature, and level indicating systems;*

- *satisfactory operation of cargo compressors;*
- *satisfactory operation of cargo pumps;*
- *inert gas generator, if operating;*
- *nitrogen generating plant, if operating;*
- *nitrogen pressure control system for insulation, inter-barrier, and annular spaces, as applicable;*
- *(**) review of records for satisfactory operation of the reliquefaction plant, if fitted;*
- *review of records for equipment fitted for the burning of cargo vapours such as boilers, engines, gas combustion units, etc.;*
- *(**) on ships fitted with membrane tanks, review records of the cofferdam and inner hull temperature sensors to verify the readings are not below the allowable temperature for the selected grade of steel;*
- *(**) cofferdam heating system, if in operation;*
- *(**) review logbook entries for cold spot examination; and*
- *(**) review logbook entry for testing of high-level alarm(s) with liquid cargo. If cargo conditions did not permit testing, surveyor to require testing at the first occasion where cargo conditions allow for testing. Master to be advised to record testing in ship's logbook which is to be verified no later than the first annual survey.*

Documentation to be requested to the Master

To demonstrate satisfactory functionality of the verifications, ship's Master shall be required to arrange and provide to the surveyor print outs or screen shots showing:

- *trends of cargo tanks pressure and temperature;*
 - *trends of pressure and temperature distribution of inter-barrier space(s) and insulation space(s), and temperature distribution of inner hull, as applicable;*
 - *trends record of performance of cofferdam heating system, when fitted;*
 - *trends record of consumption of nitrogen gas, and whether any abnormality has been observed;*
- *list of any gas alarms, if occurred:*
 - *Cargo Tanks Containment System Cold Spot Inspection Statement; and*
 - *activation of Cargo Tanks High-Level Alarm and Overfill Protection tests. (IACS UI GC13)*

4.20.3.6 Heating arrangements, if fitted in accordance with 4.19.1.5 and 4.19.1.6, shall be tested for required heat output and heat distribution.

Note: IACS Interpretation in 4.20.3.5 also applies to this 4.20.3.6.

4.20.3.7 The cargo containment system shall be inspected for cold spots during, or immediately following, the first loaded voyage. Inspection of the integrity of thermal insulation surfaces that cannot be visually checked shall be carried out in accordance with recognized standards.

Note: IACS Interpretation in 4.20.3.5 also applies to this 4.20.3.7.

Part E

TANK TYPES

4.21 Type A independent tanks

4.21.1 Design basis

4.21.1.1 Type A independent tanks are tanks primarily designed using classical ship-structural analysis procedures in accordance with recognized standards. Where such tanks are primarily constructed of plane surfaces, the design vapour pressure P_o shall be less than 0.07 MPa.

4.21.1.2 If the cargo temperature at atmospheric pressure is below -10°C, a complete secondary barrier shall be provided as required in 4.5. The secondary barrier shall be designed in accordance with 4.6.

4.21.2 Structural analysis

4.21.2.1 A structural analysis shall be performed taking into account the internal pressure as indicated in 4.13.2, and the interaction loads with the supporting and keying system as well as a reasonable part of the ship's hull.

4.21.2.2 For parts, such as supporting structures, not otherwise covered by the requirements of these *Rules* (the Code), stresses shall be determined by direct calculations, taking into account the loads referred to in 4.12 to 4.15 as far as applicable, and the ship deflection in way of supporting structures.

4.21.2.3 The tanks with supports shall be designed for the accidental loads specified in 4.15. These loads need not be combined with each other or with environmental loads.

4.21.3 *Ultimate design condition*

4.21.3.1 For tanks primarily constructed of plane surfaces, the nominal membrane stresses for primary and secondary members (stiffeners, web frames, stringers, girders), when calculated by classical analysis procedures, shall not exceed the lower of $R_m/2.66$ or $R_e/1.33$ for nickel steels, carbon-manganese steels, austenitic steels and aluminium alloys, where R_m and R_e are defined in 4.18.1.3. However, if detailed calculations are carried out for the primary members, the equivalent stress σ_c , as defined in 4.18.1.4, may be increased over that indicated above to a stress acceptable to the Administration or recognized organization acting on its behalf. Calculations shall take into account the effects of bending, shear, axial and torsional deformation as well as the hull/cargo tank interaction forces due to the deflection of the double bottom and cargo tank bottoms.

4.21.3.2 Tank boundary scantlings shall meet at least the requirements of the Administration or recognized organization acting on its behalf for deep tanks taking into account the internal pressure as indicated in 4.13.2 and any corrosion allowance required by 4.3.5.

4.21.3.3 The cargo tank structure shall be reviewed against potential buckling.

4.21.4 *Accident design condition*

4.21.4.1 The tanks and the tank supports shall be designed for the accidental loads and design conditions specified in 4.3.4.3 and 4.15, as relevant.

4.21.4.2 When subjected to the accidental loads specified in 4.15, the stress shall comply with the acceptance criteria specified in 4.21.3, modified as appropriate, taking into account their lower probability of occurrence.

4.21.5 *Testing*

All type A independent tanks shall be subjected to a hydrostatic or hydropneumatic test. This test shall be performed such that the stresses approximate, as far as practicable, the design stresses, and that the pressure at the top of the tank corresponds at least to the MARVS. When a hydropneumatic test is performed, the conditions shall simulate, as far as practicable, the design loading of the tank and of its support structure, including dynamic components, while avoiding stress levels that could cause permanent deformation.

4.22 *Type B independent tanks*

4.22.1 *Design basis*

4.22.1.1 Type B independent tanks are tanks designed using model tests, refined analytical tools and analysis methods to determine stress levels, fatigue life and crack propagation characteristics. Where such tanks are primarily constructed of plane surfaces (prismatic tanks), the design vapour pressure P_o shall be less than 0.07 MPa.

4.22.1.2 If the cargo temperature at atmospheric pressure is below -10°C , a partial secondary barrier with a small leak protection system shall be provided as required in 4.5. The small leak protection system shall be designed according to 4.7.

4.22.2 Structural analysis

4.22.2.1 The effects of all dynamic and static loads shall be used to determine the suitability of the structure with respect to:

- .1 plastic deformation;
- .2 buckling;
- .3 fatigue failure; and
- .4 crack propagation.

Finite element analysis or similar methods and fracture mechanics analysis, or an equivalent approach, shall be carried out.

4.22.2.2 A three-dimensional analysis shall be carried out to evaluate the stress levels, including interaction with the ship's hull. The model for this analysis shall include the cargo tank with its supporting and keying system, as well as a reasonable part of the hull.

4.22.2.3 A complete analysis of the particular ship accelerations and motions in irregular waves, and of the response of the ship and its cargo tanks to these forces and motions shall be performed, unless the data is available from similar ships.

4.22.3 Ultimate design condition

4.22.3.1 Plastic deformation

4.22.3.1.1 For type B independent tanks, primarily constructed of bodies of revolution, the allowable stresses shall not exceed:

$$\begin{aligned}\sigma_m &\leq f \\ \sigma_L &\leq 1.5f \\ \sigma_b &\leq 1.5F \\ \sigma_L + \sigma_b &\leq 1.5F \\ \sigma_m + \sigma_b &\leq 1.5F \\ \sigma_m + \sigma_b + \sigma_g &\leq 3.0F \\ \sigma_L + \sigma_b + \sigma_g &\leq 3.0F\end{aligned}$$

where:

- σ_m = equivalent primary general membrane stress;
- σ_L = equivalent primary local membrane stress;
- σ_b = equivalent primary bending stress;
- σ_g = equivalent secondary stress;
- f = the lesser of (R_m/A) or (R_e/B) ; and
- F = the lesser of (R_m/C) or (R_e/D) ,

with R_m and R_e as defined in 4.18.1.3. With regard to the stresses σ_m , σ_L , σ_b and σ_g , the definition of stress categories in 4.28.3 are referred. The values A and B shall be shown on the *International Certificate of Fitness for the Carriage of Liquefied Gases in Bulk* and shall have at least the following minimum values:

	Nickel steels and carbon manganese steels	Austenitic steels	Aluminium alloys
A	3	3.5	4
B	2	1.6	1.5
C	3	3	3
D	1.5	1.5	1.5

The above figures may be altered, taking into account the design condition considered in acceptance with the Administration.

4.22.3.1.2 For type B independent tanks, primarily constructed of plane surfaces, the allowable membrane equivalent stresses applied for finite element analysis shall not exceed:

- .1 for nickel steels and carbon-manganese steels, the lesser of $R_m/2$ or $R_e/1.2$;
- .2 for austenitic steels, the lesser of $R_m/2.5$ or $R_e/1.2$; and
- .3 for aluminium alloys, the lesser of $R_m/2.5$ or $R_e/1.2$.

The above figures may be amended, taking into account the locality of the stress, stress analysis methods and design condition considered in acceptance with the Administration.

4.22.3.1.3 The thickness of the skin plate and the size of the stiffener shall not be less than those required for type A independent tanks.

4.22.3.2 Buckling

Buckling strength analyses of cargo tanks subject to external pressure and other loads causing compressive stresses shall be carried out in accordance with recognized standards. The method shall adequately account for the difference in theoretical and actual buckling stress as a result of plate edge misalignment, lack of straightness or flatness, ovality and deviation from true circular form over a specified arc or chord length, as applicable.

4.22.4 Fatigue design condition

4.22.4.1 Fatigue and crack propagation assessment shall be performed in accordance with 4.18.2. The acceptance criteria shall comply with 4.18.2.7, 4.18.2.8 or 4.18.2.9, depending on the detectability of the defect.

4.22.4.2 Fatigue analysis shall consider construction tolerances.

4.22.4.3 Where deemed necessary by the Administration, model tests may be required to determine stress concentration factors and fatigue life of structural elements.

4.22.5 Accident design condition

4.22.5.1 The tanks and the tank supports shall be designed for the accidental loads and design conditions specified in 4.3.4.3 and 4.15, as applicable.

4.22.5.2 When subjected to the accidental loads specified in 4.15, the stress shall comply with the acceptance criteria specified in 4.22.3, modified as appropriate, taking into account their lower probability of occurrence.

4.22.6 Testing

Type B independent tanks shall be subjected to a hydrostatic or hydropneumatic test as follows:

- .1 the test shall be performed as required in 4.21.5 for type A independent tanks; and

- .2 in addition, the maximum primary membrane stress or maximum bending stress in primary members under test conditions shall not exceed 90% of the yield strength of the material (as fabricated) at the test temperature. To ensure that this condition is satisfied, when calculations indicate that this stress exceeds 75% of the yield strength, the prototype test shall be monitored by the use of strain gauges or other suitable equipment.

4.22.7 Marking

Any marking of the pressure vessel shall be achieved by a method that does not cause unacceptable local stress raisers.

4.23 Type C independent tanks

Note:

Many of the below requirements for type C independent tanks (from 4.23.1 to 4.23.6) are repeated in IACS UR G2 *Liquefied gas cargo tanks and process pressure vessels* -see 4.23.8.

4.23.1 Design basis

4.23.1.1 The design basis for type C independent tanks is based on pressure vessel criteria modified to include fracture mechanics and crack propagation criteria. The minimum design pressure defined in 4.23.1.2 is intended to ensure that the dynamic stress is sufficiently low, so that an initial surface flaw will not propagate more than half the thickness of the shell during the lifetime of the tank.

4.23.1.2 The design vapour pressure shall not be less than:

$$P_O = 0,2 + AC(\rho_r)^{1,5} \quad (\text{MPa})$$

where:

$$A = 0,00185 \left(\frac{\sigma_m}{\Delta\sigma_A} \right)^2$$

with:

σ_m = design primary membrane stress;

$\Delta\sigma_A$ = allowable dynamic membrane stress (double amplitude at probability level $Q = 10^{-8}$) and equal to:

– 55 N/mm² for ferritic-perlitic, martensitic and austenitic steel;

– 25 N/mm² for aluminium alloy (5083-O)

C = a characteristic tank dimension to be taken as the greatest of the following:

h , $0.75b$ or $0.45l$

with:

h = height of tank (dimension in ship's vertical direction) (m);

b = width of tank (dimension in ship's transverse direction)(m);

l = length of tank (dimension in ship's longitudinal direction) (m);

ρ_r = the relative density of the cargo ($\rho_r = 1$ for fresh water) at the design temperature.

When a specified design life of the tank is longer than 10^8 wave encounters, $\Delta\sigma_A$ shall be modified to give equivalent crack propagation corresponding to the design life.

IACS interpretation

Carriage of products not covered by the code

1. If the carriage of products not covered by the Code * is intended, it should be verified that the double amplitude of the primary membrane stress $\Delta\sigma_m$ created by the maximum dynamic pressure differential ΔP does not exceed the allowable double amplitude of the dynamic membrane stress $\Delta\sigma_A$ as specified in paragraph 4.23.1.2 of these Rules (the Code), ie:



$$\Delta\sigma_m \leq \Delta\sigma_A$$

2. The dynamic pressure differential ΔP in MPa should be calculated as follows:

$$\Delta P = \frac{\rho}{1,02 \cdot 10^5} (a_{\beta 1} Z_{\beta 1} - a_{\beta 2} Z_{\beta 2})$$

where:

ρ is maximum liquid cargo density in kg/m³ at the design temperature

a_{β} , Z_{β} are as defined in 4.28.1.2 of these Rules (the Code), see also Figure below

$a_{\beta 1}$, $Z_{\beta 1}$ are the a_{β} and Z_{β} values giving the maximum liquid pressure $(P_{gd})_{\max}$

$a_{\beta 2}$, $Z_{\beta 2}$ are the a_{β} and Z_{β} values giving the minimum liquid pressure $(P_{gd})_{\min}$

In order to evaluate the maximum pressure differential ΔP , pressure differentials should be evaluated over the full range of the acceleration ellipse as shown in the sketches given below.

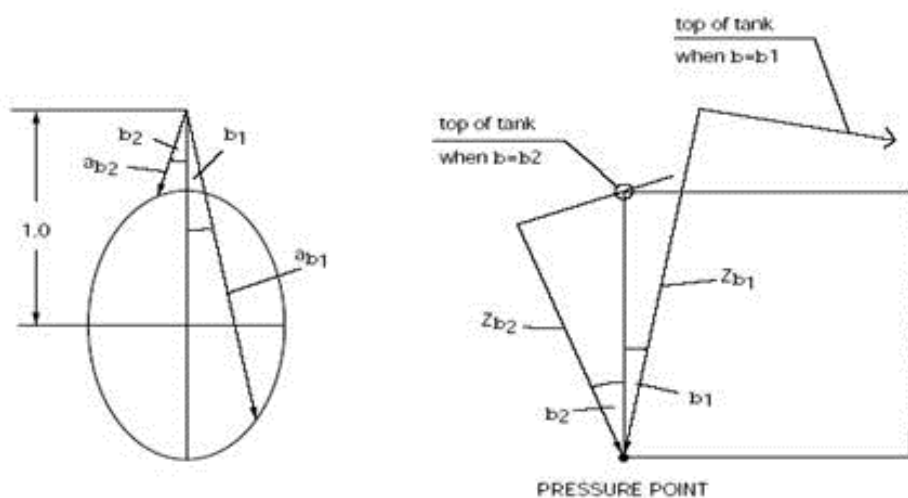

NOTE:

* The outlined procedure is only applicable to products having a relative density exceeding 1,0. (IACS UI GC7)

4.23.1.3 The Administration may allocate a tank complying with the criteria of type C tank minimum design pressure as in 4.23.1.2, to a type A or type B, dependent on the configuration of the tank and the arrangement of its supports and attachments.

4.23.2 Shell thickness

4.23.2.1 The shell thickness shall be as follows:

- .1 For pressure vessels, the thickness calculated according to 4.23.2.4 shall be considered as a minimum thickness after forming, without any negative tolerance.
- .2 For pressure vessels, the minimum thickness of shell and heads including corrosion allowance, after forming, shall not be less than 5 mm for carbon-manganese steels and nickel steels, 3 mm for austenitic steels or 7 mm for aluminium alloys.
- .3 The welded joint efficiency factor to be used in the calculation according to 4.23.2.4 shall be 0.95 when the inspection and the non-destructive testing referred to in 6.5.6.5 are carried out. This figure may be increased up to 1 when account is taken of other considerations, such as the material used, type of joints, welding procedure and type of loading. For process pressure vessels, the Administration or recognized organization acting on its behalf may accept partial non-destructive examinations, but not less than those of 6.5.6.5, depending on such factors as the material used, the design temperature,

the nil-ductility transition temperature of the material, as fabricated, and the type of joint and welding procedure, but in this case an efficiency factor of not more than 0.85 shall be adopted. For special materials, the above-mentioned factors shall be reduced, depending on the specified mechanical properties of the welded joint.

4.23.2.2 The design liquid pressure defined in 4.13.2 shall be taken into account in the internal pressure calculations.

4.23.2.3 The design external pressure P_e , used for verifying the buckling of the pressure vessels, shall not be less than that given by:

$$P_e = P_1 + P_2 + P_3 + P_4 \quad (\text{MPa}),$$

where:

- P_1 = setting value of vacuum relief valves. For vessels not fitted with vacuum relief valves, P_1 shall be specially considered, but shall not, in general, be taken as less than 0.025 MPa;
- P_2 = the set pressure of the pressure relief valves (PRVs) for completely closed spaces containing pressure vessels or parts of pressure vessels; elsewhere $P_2 = 0$;
- P_3 = compressive actions in or on the shell due to the weight and contraction of thermal insulation, weight of shell including corrosion allowance and other miscellaneous external pressure loads to which the pressure vessel may be subjected. These include, but are not limited to, weight of domes, weight of towers and piping, effect of product in the partially filled condition, accelerations and hull deflection. In addition, the local effect of external or internal pressures or both shall be taken into account; and
- P_4 = external pressure due to head of water for pressure vessels or part of pressure vessels on exposed decks; elsewhere $P_4 = 0$.

4.23.2.4 Scantlings based on internal pressure shall be calculated as follows: the thickness and form of pressure-containing parts of pressure vessels, under internal pressure, as defined in 4.13.2, including flanges, shall be determined. These calculations shall in all cases be based on accepted pressure vessel design theory. Openings in pressure-containing parts of pressure vessels shall be reinforced in accordance with recognized standards.

4.23.2.5 Stress analysis in respect of static and dynamic loads shall be performed as follows:

- .1 Pressure vessel scantlings shall be determined in accordance with 4.23.2.1 to 4.23.2.4 and 4.23.3.
- .2 Calculations of the loads and stresses in way of the supports and the shell attachment of the support shall be made. Loads referred to in 4.12 to 4.15 shall be used, as applicable. Stresses in way of the supporting structures shall be to a recognized standard acceptable to the Administration or recognized organization acting on its behalf. In special cases, a fatigue analysis may be required by the Administration or recognized organization acting on its behalf.
- .3 If required by the Administration or recognized organization acting on its behalf, secondary stresses and thermal stresses shall be specially considered.

4.23.3 *Ultimate design condition*

4.23.3.1 Plastic deformation

For type C independent tanks, the allowable stresses shall not exceed:

$$\begin{aligned} \sigma_m & \leq f \\ \sigma_L & \leq 1.5f \\ \sigma_b & \leq 1.5f \end{aligned}$$

$$\begin{aligned} \sigma_L + \sigma_b &\leq 1.5f \\ \sigma_m + \sigma_b &\leq 1.5f \\ \sigma_m + \sigma_b + \sigma_g &\leq 3.0f \\ \sigma_L + \sigma_b + \sigma_g &\leq 3.0f \end{aligned}$$

where:

- σ_m = equivalent primary general membrane stress;
- σ_L = equivalent primary local membrane stress;
- σ_b = equivalent primary bending stress;
- σ_g = equivalent secondary stress;
- f = the lesser of R_m/A or R_e/B ,

with R_m and R_e as defined in 4.18.1.3. With regard to the stresses σ_m , σ_L , σ_b and σ_g , the definition of stress categories in 4.28.3 are referred. The values A and B shall be shown on the *International Certificate of Fitness for the Carriage of Liquefied Gases in Bulk* and shall have at least the following minimum values:

	Nickel steels and carbon manganese steels	Austenitic steels	Aluminium alloys
A	3	3.5	4
B	1.5	1.5	1.5

IACS interpretation

Permissible stresses in way of supports of type C cargo tanks

The circumferential stresses at supports shall be calculated by a procedure acceptable to the Classification Society for a sufficient number of load cases.

1. Permissible stresses in stiffening rings:

For horizontal cylindrical tanks made of C-Mn steel supported in saddles, the equivalent stress in the stiffening rings shall not exceed the following values if calculated using finite element method:

$$\sigma_e \leq \sigma_{all}$$

where:

$$\sigma_{all} = \min (0.57R_m; 0.85R_e)$$

$$\sigma_e = \sqrt{(\sigma_n + \sigma_b)^2 + 3\tau^2}$$

σ_e = von Mises equivalent stress in N/mm²

σ_n = normal stress in N/mm² in the circumferential direction of the stiffening ring

σ_b = bending stress in N/mm² in the circumferential direction of the stiffening ring

τ = shear stress in N/mm² in the stiffening ring

R_m and R_e as defined in 4.18.1.3 of these Rules (the Code).

Equivalent stress values σ_e should be calculated over the full extent of the stiffening ring by a procedure acceptable to the Classification Society, for a sufficient number of load cases.

2. The following assumptions should be made for the stiffening rings:

2.1 The stiffening ring should be considered as a circumferential beam formed by web, face plate, doubler plate, if any, and associated shell plating.

The effective width of the associated plating should be taken as:

.1 For cylindrical shells:

an effective width (mm) not greater than $0.78\sqrt{rt}$ on each side of the web. A doubler plate, if any, may be included within that distance.

where:

r = mean radius of the cylindrical shell (mm)

t = shell thickness (mm)

.2 For longitudinal bulkheads (in the case of lobe tanks):

the effective width should be determined according to established standards. A value of 20 t_b on each side of the web may be taken as a guidance value.

where:

t_b = bulkhead thickness (mm).

2.2 The stiffening ring should be loaded with circumferential forces, on each side of the ring, due to the shear stress, determined by the bi-dimensional shear flow theory from the shear force of the tank.

3. For calculation of reaction forces at the supports, the following factors should be taken into account:

3.1 Elasticity of support material (intermediate layer of wood or similar material).

3.2 Change in contact surface between tank and support, and of the relevant reactions, due to:

- thermal shrinkage of tank
- elastic deformations of tank and support material.

The final distribution of the reaction forces at the supports should not show any tensile forces.

4. The buckling strength of the stiffening rings should be examined. (IACS UI GC8)

4.23.3.2 Buckling criteria shall be as follows: the thickness and form of pressure vessels subject to external pressure and other loads causing compressive stresses shall be based on calculations using accepted pressure vessel buckling theory and shall adequately account for the difference in theoretical and actual buckling stress as a result of plate edge misalignment, ovality and deviation from true circular form over a specified arc or chord length.

4.23.4 Fatigue design condition

For large type C independent tanks, where the cargo at atmospheric pressure is below -55°C, the Administration or recognized organization acting on its behalf may require additional verification to check their compliance with 4.23.1.1 regarding static and dynamic stress.

4.23.5 Accident design condition

4.23.5.1 The tanks and the tank supporting structures shall be designed for the accidental loads and design conditions specified in 4.3.4.3 and 4.15, as applicable.

4.23.5.2 When subjected to the accidental loads specified in 4.15, the stress shall comply with the acceptance criteria specified in 4.23.3.1, modified as appropriate taking into account their lower probability of occurrence.

4.23.6 Testing

4.23.6.1 Each pressure vessel shall be subjected to a hydrostatic test at a pressure measured at the top of the tanks, of not less than 1.5 P_o . In no case during the pressure test shall the calculated primary membrane stress at any point exceed 90% of the yield stress of the material. To ensure that this condition is satisfied where calculations indicate that this stress will exceed 0.75 times the yield strength, the prototype test shall be monitored by the use of strain gauges or other suitable equipment in pressure vessels other than simple cylindrical and spherical pressure vessels.

4.23.6.2 The temperature of the water used for the test shall be at least 30°C above the nil-ductility transition temperature of the material, as fabricated.

4.23.6.3 The pressure shall be held for 2 h per 25 mm of thickness, but in no case less than 2 h.

4.23.6.4 Where necessary for cargo pressure vessels, a hydropneumatic test may be carried out under the conditions prescribed in 4.23.6.1 to 4.23.6.3.

4.23.6.5 Special consideration may be given to the testing of tanks in which higher allowable stresses are used, depending on service temperature. However, the requirements of 4.23.6.1 shall be fully complied with.

4.23.6.6 After completion and assembly, each pressure vessel and its related fittings shall be subjected to an adequate tightness test which may be performed in combination with the pressure testing referred to in 4.23.6.1.

4.23.6.7 Pneumatic testing of pressure vessels other than cargo tanks shall only be considered on an individual case basis. Such testing shall only be permitted for those vessels designed or supported such that they cannot be safely filled with water, or for those vessels that cannot be dried and are to be used in a service where traces of the testing medium cannot be tolerated.

4.23.7 Marking

The required marking of the pressure vessel shall be achieved by a method that does not cause unacceptable local stress raisers.

4.23.8 *Liquefied gas cargo tanks and process pressure vessels*

IACS UR G2

Note:

UR G2 collects in one place various requirements from the IGC Code (these *Rules*) applicable to independent cargo tanks type C (i.e. pressure cargo tanks). Majority of the below requirements are repetition of the IGC Code requirements. Where relevant references to the IGC Code original requirements (i.e.: see also ...) are given in brackets at the end of particular paragraphs.

4.23.8.1 General (G2.1)

4.23.8.1.1 The present texts give the general principles which are applied by Classification Societies for approval and survey of the relevant items of liquefied gas tankers for classification purpose. They do not intend to cover full details of such approval and survey procedures which are to be found in the individual Rules of Classification Societies. (G2.1.1)

4.23.8.1.2 Where appropriate, these Rules refer to the basic tank types which are defined under 4.1 of IGC Code. Tanks differing from these definitions will be the subject of special consideration. (G2.1.2)

4.23.8.1.3 Consideration of future technical advances may warrant modifications to the principles and details set forth in the text. IACS will accordingly review continuously these requirements. (G2.1.3)

4.23.8.1.4 When reference is made in this Requirement to 'Classification Society', only members or associates of IACS are considered. (G2.1.4)

4.23.8.1.5 IGC Code means the International Code for the Construction and Equipment of Ships Carrying Liquefied Gases in Bulk (as amended by IMO Resolutions MSC.370(93), MSC.411(97) and MSC.441(99)). (G2.1.5)

4.23.8.2 Scope

The requirements here below apply to independent cargo tanks type C (pressure cargo tanks) such as defined in 4.23 of these *Rules* (the IGC Code). They may also apply to process pressure vessels if required by the Classification Society. The words 'pressure vessels' are used in this text to cover the two above-mentioned categories. These requirements apply to tanks and vessels made of materials defined in 6.4.2 (W1) and the IGC Code. (G2.2)

4.23.8.3 Calculation of thickness under internal pressure (G2.3)

4.23.8.3.1 General

For pressure vessels, the thickness calculated according to 4.23.2.4 of these *Rules* (the IGC Code) shall be considered as a minimum thickness after forming, without any negative tolerance. (see also 4.23.1)

Scantlings based on internal pressure shall be calculated as follows: the thickness and form of pressure containing parts of pressure vessels under internal pressure, including flanges, are to be determined according to the Rules of the Classification Society. These calculations are to be based in all cases on generally accepted pressure vessel design theory. (see also 4.23.4)

Openings in pressure containing parts of pressure vessels are to be reinforced in accordance with the Rules of the Classification Society. (see also 4.23.4) (G2.3.1)

4.23.8.3.2 Design pressure

For calculation according to 4.23.8.3.1 (G2.3.1), the design liquid pressure defined under 4.13.2 of these *Rules* (the IGC Code) is to be taken into account in the internal pressure calculations. (G2.3.2)

4.23.8.3.3 Efficiency factor for welded joints

The welded joint efficiency factor to be used in calculation according to 4.23.8.3.1 (G2.3.1) is to be 0.95 when the inspection and non-destructive examination stated under 4.23.8.9.2 (G2.9.2) (i) are carried out.

This figure may be increased up to 1.0 taking into account other considerations, such as materials used, type of joints, welding procedure, type of loading, etc. For process pressure vessels, the Classification Society may accept partial non-destructive examinations, but not less than those under 4.23.8.9.2 (G2.9.2) (ii) may be allowed depending on the material used, the design temperature, the nil ductility temperature of the material as fabricated, the type of joint, welding procedure, etc., but in this case the efficiency factor 0.85 is to be adopted.

For special materials, the above mentioned factors are to be reduced depending on the specified mechanical properties of the welded joint. (see also 4.23.2.1.3) (G2.3.3)

4.23.8.3.4 Maximum allowable stress

The maximum allowable stresses to be used in calculation according to 4.23.8.3.1 (G2.3.1) shall not exceed the value defined in 4.23.3.1 of these *Rules* (the IGC Code). (G2.3.4)

4.23.8.3.5 Corrosion allowance

Corrosion allowance need not be required in addition to the thickness resulting from the structural analysis. However, where there is no environmental control, such as inerting around the cargo tank, or where the cargo is of a corrosive nature, the Classification Society may require a suitable corrosion allowance. (see also 4.3.5) (G2.3.5)

4.23.8.3.6 Minimum thickness of shell and heads

The thickness, including corrosion allowance, after forming of any shell and head is not to be less than 5 mm for C-Mn steels and Ni steels, 3 mm for austenitic steel or 7 mm for aluminium alloy. (see also 4.23.2.1.2) (G2.3.6)

4.23.8.4 Buckling criteria (G2.4)

4.23.8.4.1 General

Buckling criteria shall be as follows: the thickness and form of pressure vessels subject to external pressure and other loads causing compressive stresses are to be calculated according to the Rules of the Classification Society. These calculations in all cases are to be based on generally accepted pressure vessel buckling theory and are to adequately account for the difference in theoretical and actual buckling stress as a result of plate edge misalignment, ovality and deviation from true circular form over a specified arc or chord length. (see also 4.23.3.2) (G2.4.1)

4.23.8.4.2 Design external pressure

The design external pressure P_e to be used for verifying the buckling of the pressure vessels is given by the following formula:

$$P_e = P_1 + P_2 + P_3 + P_4 \text{ (MPa)}$$

where:

P_1 = setting value of vacuum relief valves. For vessels not fitted with vacuum relief valves, P_1 is to be specially considered, but is, in general, not to be taken less than 0.025 MPa.

P_2 = for pressure vessels or parts of pressure vessels in completely closed spaces: the set pressure of the pressure relief valves for these spaces.

Elsewhere $P_2 = 0$.

P_3 = compressive actions in the shell due to the weight and contraction of insulation, weight of shell, including corrosion allowance, and other miscellaneous external pressure loads to which the pressure vessel may be subjected. These include but are not limited to weight of domes, weight of towers and piping, effect of product in the partially filled condition, accelerations and hull deflection. The local effect of external and/or internal pressure is also to be taken into account.

P_4 = external pressure due to head of water for pressure vessels or part of pressure vessels on exposed decks.

Elsewhere $P_4 = 0$. (see also 4.23.2.3) (G2.4.2)

4.23.8.5 Stress analysis in respect of static and dynamic loads (see also 4.23.2.5.1 to 4.23.2.5.3) (G2.5)

4.23.8.5.1 Pressure vessel scantlings are to be determined in accordance with 4.23.8.3 and 4.23.8.4 (G2.3 and G2.4). (G2.5.1)

4.23.8.5.2 Calculations of the loads and stresses in way of the supports and the shell attachment of the support are to be made. Loads as applicable, from 4.12 to 4.15 of these *Rules* (the IGC Code), are to be used. Stresses in way of the supports are to be according to a recognized standard acceptable to the Classification Society. (G2.5.2)

4.23.8.5.3 Furthermore, when required by the Classification Society, secondary stresses and thermal stresses are to be specially considered. (G2.5.3)

4.23.8.5.4 In special cases, a fatigue analysis may be required by the Classification Society. (G2.5.4)

4.23.8.6 Accident design condition (G2.6)

4.23.8.6.1 The tanks and the tank supporting structures shall be designed for the accidental loads and design conditions specified in 4.3.4.3 and 4.15 of these *Rules* (the IGC Code), as applicable. (see also 4.23.5.1) (G2.6.1)

4.23.8.6.2 When subjected to the accidental loads specified in 4.15 of these *Rules* (the IGC Code), the stress shall comply with the acceptance criteria specified in 4.23.3.1 of these *Rules* (the IGC Code), modified as appropriate taking into account their lower probability of occurrence. (see also 4.23.5.2) (G2.6.2)

4.23.8.7 Welding joints details (G2.7)

4.23.8.7.1 All longitudinal and circumferential joints of pressure vessels are to be of butt welded, full penetration, double vee or single vee type. Full penetration butt welds are to be obtained by double welding or by the use of backing rings. If used, backing rings are to be removed except from very small process pressure vessels. Other edge preparations may be permitted depending on the results of the tests carried out at the approval of the welding procedure. (see also 4.20.1.2.1) (G2.7.1)

4.23.8.7.2 The bevel preparation of the joints between the pressure vessel body and domes and between domes and relevant fittings are to be designed according to a standard acceptable to the Classification Society. All welds connecting nozzles, domes or other penetrations to the vessel and all welds connecting flanges to the vessel or nozzles, are to be full penetration welds. (see also 4.20.1.2.2) (G2.7.2)

4.23.8.8 Stress relieving (G2.8)

4.23.8.8.1 For pressure vessels made of carbon and carbon-manganese steel, post-weld heat treatment is to be performed after welding if the design temperature is below -10°C. Postweld treatment in all other cases and for materials other than those mentioned above shall be to recognized standards acceptable to the Classification Society. The soaking temperature and holding time are to be according to the recognized standards acceptable to the Classification Society. (see also 6.6.2.2) (G2.8.1)

4.23.8.8.2 In the case of large cargo pressure vessels of carbon or carbon-manganese steel for which it is difficult to perform the heat treatment, mechanical stress relieving by pressurizing may be carried out as an alternative to the heat treatment if agreed by the Classification Society and subject to the conditions of 6.6.2.3 of these *Rules* (the IGC Code). (G2.8.2)

4.23.8.9 Inspection and non-destructive examination (G2.9)

4.23.8.9.1 Manufacture and workmanship

The tolerances relating to manufacture and workmanship (i.e. out-of-roundness, local deviations from the true form, welded joints alignment, tapering of plates having different thicknesses, etc.) are to comply with recognized standards acceptable to the Classification Society. The tolerances are also to be related to the buckling analysis (see 4.23.8.4 (G2.4)). (see also 6.6.2.1) (G2.9.1)

4.23.8.9.2 Non-destructive examination

The extent of non-destructive testing shall be total or partial according to recognized standards acceptable to the Classification Society, but the controls to be carried out shall not be less than the following:

(i) Total non-destructive examination (see 4.23.8.3.3 (G2.3.3))

Radiography

butt welds: 100%

Surface crack detection

all welds: 10%

reinforcement rings around holes, nozzles, etc: 100%

Ultrasonic testing

Ultrasonic testing may be accepted for replacing partially the radiographic examination, if so specially allowed by the Classification Society. In addition the Society may require a total ultrasonic examination on welding of reinforcement rings and holes, nozzles, etc.

(ii) Partial non-destructive examination (see 4.23.8.3.3 (G2.3.3))

Radiography

butt welds: all welded joints crossing and at least 10% of the full length at selected positions uniformly distributed

Surface crack detection

reinforcement rings around holes, nozzles, etc 100%

Ultrasonic testing

as may be required by the Classification Society in each instance. (G2.9.2)

4.23.8.10 Pressure testing (G2.10)

4.23.8.10.1 Each pressure vessel is to be subjected to a hydrostatic test according to the Rules of the Classification Society, at a pressure, measured at the top of the tanks, of not less than $1.5 P_0$. In no case during the pressure test is the calculated primary membrane stress at any point to exceed 90% of the yield stress of material (for definition of P_0 , see 4.1.2 of these Rules (the IGC Code)). To ensure that this condition is satisfied where calculations indicate that this stress will exceed 0.75 times the yield strength, the prototype test is to be monitored by the use of strain gauges or other suitable equipment in pressure vessels except simple cylindrical and spherical pressure vessels. (G2.10.1)

4.23.8.10.2 The temperature of the water used for test is to be at least 30°C above the nil ductility transition temperature of the material as fabricated. (G2.10.2)

4.23.8.10.3 The pressure is to be held for two hours per 25 mm of thickness but in no case less than two hours. (G2.10.3)

4.23.8.10.4 Where necessary for cargo pressure vessels, there may be carried out with specific approval of the Classification Society, a hydropneumatic test in the conditions prescribed under 4.23.8.10.1, 4.23.8.10.2 and 4.23.8.10.3 (G2.10.1, G2.10.2 and G2.10.3). (G2.10.4)

4.23.8.10.5 Special consideration will be given to testing of tanks in which higher allowable stresses are used depending on service temperature. However, the requirements of G2.10.1 are to be fully complied with. (G2.10.5)

4.23.8.10.6 After completion and assembly, each pressure vessel and relative fittings are to be subjected to an adequate tightness test which may be performed in combination with the pressure testing referred to in 4.23.8.10.1 (G2.10.1). (G2.10.6)

4.23.8.10.7 Pneumatic testing of pressure vessels other than cargo tanks will be considered on an individual case basis by the Classification Society. Such testing will be permitted only for those vessels which are so designed and/or supported that they cannot be safely filled with water, or for those vessels which cannot be dried and are to be used in a service where traces of the testing medium cannot be tolerated. (G2.10.7)

END OF IACS UR G2

4.23.9 *Recommended procedure for the finite element analysis to assess yielding, buckling and fatigue strength of IGC Code type C tanks*

IACS REC 174

Note: This is a non-mandatory, recommended procedure for the FEM analysis.

4.23.9.1 **Scope of application** (1)

4.23.9.1.1 This document provides general information and recommendations for the finite element analysis of single cylinder and multi-lobe shape type C tanks of these *Rules* (IGC Code). (1.1)

4.23.9.1.2 The corrosion allowance is excluded in this document and can be considered by the Classification Society as needed. (1.2)

4.23.9.2 **Yielding strength assessment** (2)

4.23.9.2.1 **General** (2.1)

4.23.9.2.1.1 Finite element analysis of a type C tank may be required as a supplementary assessment where the structural strength cannot be duly assessed by the prescriptive requirements of each Classification Society, i.e. stress concentration locations such as structural discontinuities in way of tank supports, Y-connections of multi-lobe tanks and tanks of novel design or configuration. (2.1.1)

4.23.9.2.2 **Modelling** (2.2)

4.23.9.2.2.1 The entire tank and supporting saddle structures should be modelled including any discontinuities which might affect the stress distribution significantly. The FE model should include the tank shell, ring stiffeners, internal bulkheads and all major components attached to the tank. Examples are shown in Figure 1.

Both 2D shell elements and solid 3D elements are acceptable for the analysis and subsequent stress calculations. In principle, elements of second order which are with additional internal degrees of freedom for improved in plane element behaviour are recommended. Also the limitations of shell elements in assessing secondary/peak/hot spot stresses should be considered. (2.2.1)

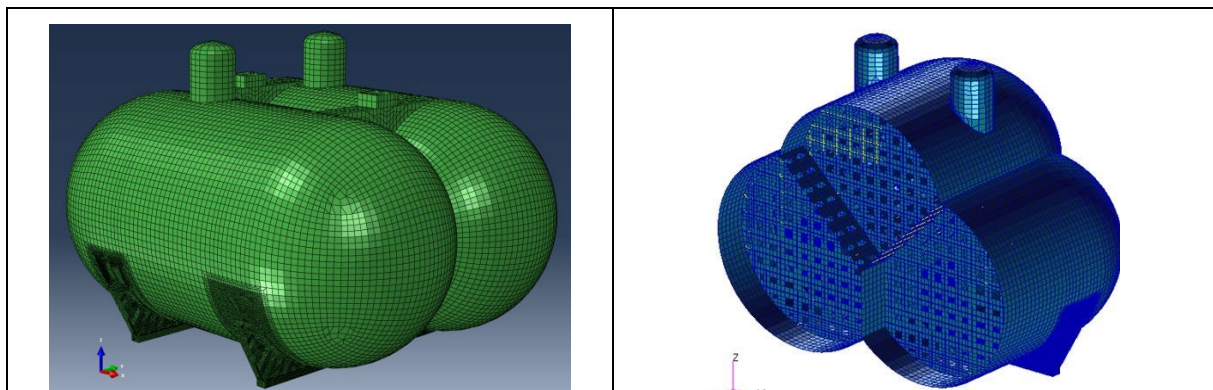

Figure 1 Finite element models of type C tanks (bi-lobe and tri-lobe)

4.23.9.2.2.2 For the local areas of structural discontinuity where it is intended to evaluate result including secondary stresses:

- It is recommended to use 8-node shell elements or 4-nodes shell elements with additional internal degree of freedom, and with the mesh size of $1.0 t$ up to 50 mm in principle, where t denotes the plate thickness.
- Alternatively, the element mesh size may be established by sensitivity checks in accordance with recognised standards to represent the bending deflection of tank structure and local stresses in way of the structural discontinuities.

For other areas, coarser mesh may be used as considered appropriate to simulate realistic structural response including local bending. e.g. the lesser of cylindrical radius $R/30$ or 200 mm in shell mesh size. Consideration should be given to the smooth transition to coarse mesh to get appropriate stress distribution. Stiffening rings are recommended to be modelled as shell elements. (2.2.2)

4.23.9.2.2.3 Solid elements may be necessary in order to represent the steep stress gradient distribution in the plate thickness direction in way of the local area of complex geometry, e.g. Y-connections of the bi-lobe tank, etc.

It is recommended to use iso-parametric 20-node elements with a size of plate thickness t . For 8-node solid elements, at least four elements in the thickness direction ($t \times t \times \frac{t}{4}$) should be used. When solid elements are used, it is normally required to extrapolate stresses to surfaces. The membrane and bending stress components may be obtained according to the stress linearization method determined by the recognized standards. (2.2.3)

4.23.9.2.2.4 Attention should be given to the transition area between solid elements and shell elements, if integrated, to ensure that the structural response is correctly transferred between the two types of elements. The transition area between two types of elements should be kept away from the areas with high stresses. An example is shown in Figure 2. (2.2.4)

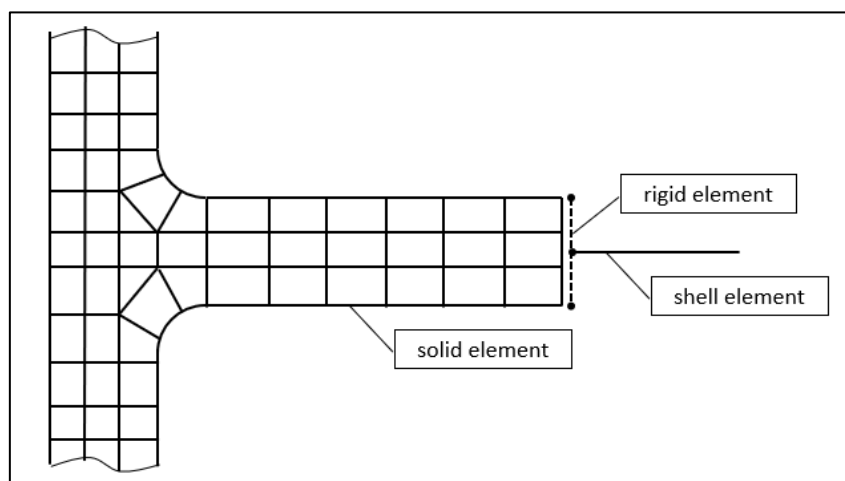

Figure 2 Transition area between solid and shell elements

4.23.9.2.2.5 If the tank is placed on supports that can be considered as contact surfaces, the relative deflections between the tank and supports should be correctly considered, especially for low temperature applications or for large diameter tanks.

Examples are shown in Figure 3. The relative deflections between the tank and the supports may significantly affect the stress distribution and so the contact surface conditions should be correctly modelled. (2.2.5)

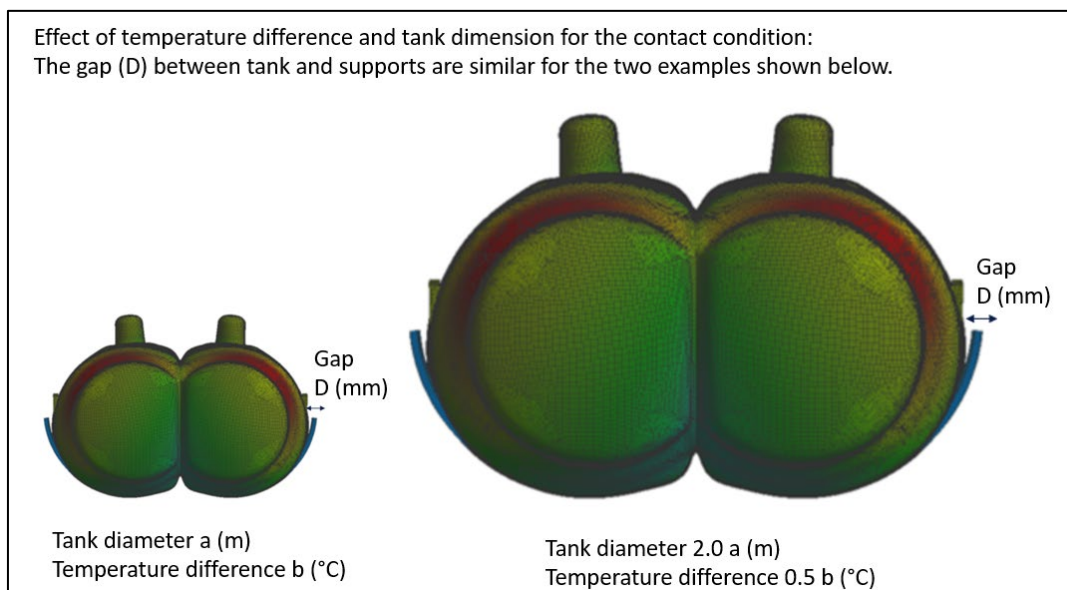

Figure 3 Modelling of contact surfaces between tank and support

4.23.9.2.2.6 The contact surfaces may be modelled in several different ways subject to the capabilities of the applied FE analysis program.

Deflection plots should be reviewed to ensure that the physics of the tank and supports are appropriately modelled where the tank is allowed to deflect relatively to the saddle shape due to the relative shrinkage between tank and saddle structure, see Figure 4 for illustration. (2.2.6)

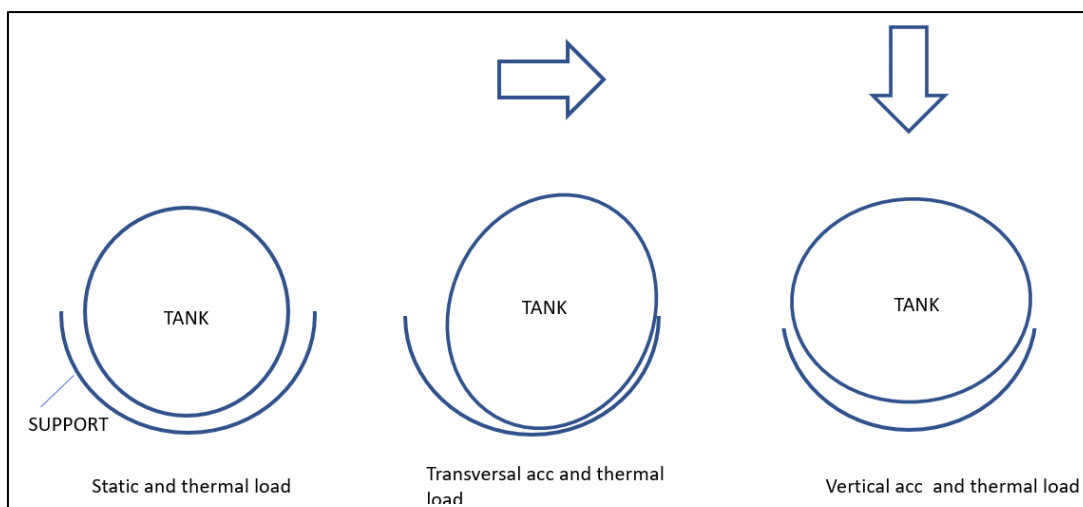

Figure 4 Contact conditions between tank and support need to allow for the relative deflection due to thermal contraction and inertial loads

4.23.9.2.2.7 For the doubler plate fitted in way of tank support and where the two independent plates are considered to influence the local stresses critically, the weld and contact conditions between doubler plate and tank body is recommended to be modelled with solid elements as shown in Figure 5. (2.2.7)

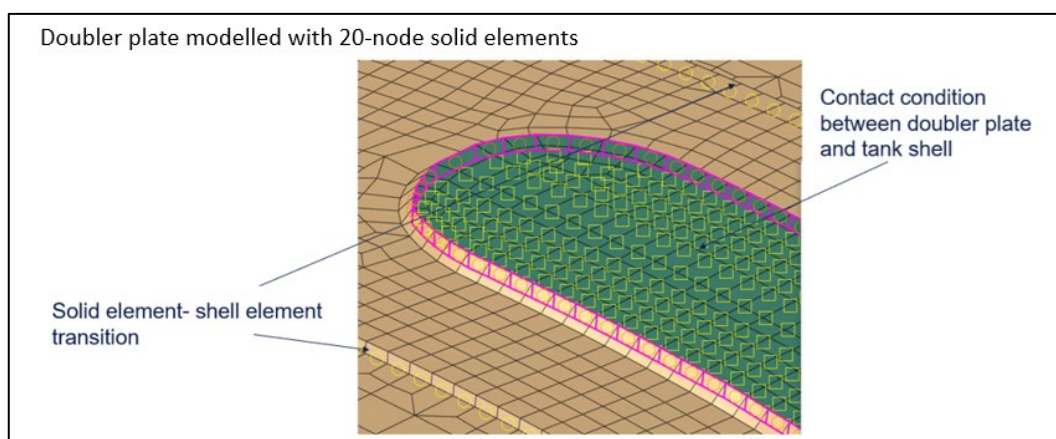

Figure 5 Recommended modelling for the doubler plate and the weld in way of tank support

4.23.9.2.3 Design load (2.3)

4.23.9.2.3.1 The ultimate, accident and testing design conditions should be assessed as outlined in Table 1. These conditions should be combinations of permanent, functional, environmental, accidental and testing loads as outlined in Table 2 as per the *Rules* (Code).

The design conditions and load cases shown on following tables should be considered for the finite element analysis. (2.3.1)

Table 1 Design conditions and load cases

Design conditions	Description	Load case
Ultimate	For the maximum load-carrying capacity or, in some cases, to the maximum applicable strain, deformation or instability in structure resulting from buckling and plastic collapse under intact (undamaged) conditions	Longitudinal dynamic
		Transverse dynamic
		Vertical dynamic
Accident	For the ability of the structure to resist accidental situations	Static heel 30° ¹⁾
		Collision
		Floatation
Testing	For hydrostatic test of each pressure vessel	Tank testing

1) The condition can also be considered to cover an ultimate limit state (ULS) condition with small GM values, which cannot be assessed by the other ULS conditions. This condition may correspond to large roll angles and consequently provides large transverse inertial loads due to the gravity component. Accordingly, the ULS criteria can be considered relevant for this condition subject to the discretion of the Classification Society.

4.23.9.2.3.2 The load combinations defined in Tables 2 to 6 should be considered for each load case. (2.3.2)

Table 2 Load combinations for considering dynamic load cases

Load case ID	Description	Permanent loads	Functional loads			Environment loads
			Filling level	Internal pressure	Thermal load	Loads due to ship motion
LD	Longitudinal acceleration	Gravity	Full	$P_{eq}^{1)}$	Min design cargo temperature ³⁾	$+a_x^{2)}$
TD	Transverse acceleration	Gravity	Full	$P_{eq}^{1)}$	See above	$+a_y^{2)}$
VD	Vertical acceleration	Gravity	Full	$P_{eq}^{1)}$	See above	$-a_z^{2)}$

- ¹⁾ Internal pressure as defined in 4.13.2.4 (IGC Code 4.13.2.4). See 'Environmental loads' column for applicable acceleration component for the calculation of internal pressure.
- ²⁾ Maximum dimensionless accelerations in longitudinal, transverse and vertical directions as defined in 4.28.2.1 (IGC Code 4.28.2.1). Direct calculation may be considered in accordance with 4.14.1.3 (IGC Code 4.14.1.3).
- ³⁾ Minimum design cargo temperature is given for tank. Applicable temperature gradient for the saddle supports can be separately considered.

Table 3 Load combinations for static heel load case

Load case ID	Description	Permanent loads	Functional loads		
			Filling level	Internal pressure	Thermal load
SH1	Static heel	Gravity	Full	<ul style="list-style-type: none"> • 30 ° static heel pressure • $P_0$¹⁾ 	Minimum design cargo temperature for tank ²⁾

¹⁾ Design vapour pressure as defined in 4.1.2 (IGC Code 4.1.2).

²⁾ Minimum design cargo temperature is given for tank. Applicable temperature gradient for the cradle supports can be separately considered.

Table 4 Load combinations for collision load cases

Load case ID	Description	Permanent loads	Functional loads			Accidental loads
			Filling level	Internal pressure	Thermal load	
CL1	Collision forward direction	Gravity	Full	<ul style="list-style-type: none"> • Collision pressure • $P_0$¹⁾ 	Minimum design temperature	0.5 g forward acceleration
CL2	Collision aft direction	Gravity	Full	<ul style="list-style-type: none"> • Collision pressure • $P_0$¹⁾ 	Minimum design temperature	0.25 g aft acceleration

¹⁾ Design vapour pressure as defined in 4.1.2 (IGC Code 4.1.2).

Table 5 Load combinations for floatation load case

Load case ID	Description	Permanent loads	Functional loads		Accidental loads
			Filling level	Thermal load	
FL1	Tank floatation	Gravity	Empty	Not applicable	Loads caused by the buoyancy of an empty tank in a hold space flooded to the summer load draught

Table 6 Load combinations for tank testing load case

Load case ID	Description	Permanent loads	Functional loads	
			Test load	Thermal load
TT1	Tank testing	Gravity	1.5 P_0 ¹⁾	Not applicable

¹⁾ Design vapour pressure as defined in 4.1.2 (IGC Code 4.1.2).

4.23.9.2.3.3 The sloshing loads should be examined separately by a procedure acceptable to the Classification Society in order to verify arrangement and strength of swash bulkheads, if fitted. (2.3.3)

4.23.9.2.4 Acceptance criteria (2.4)

4.23.9.2.4.1 The permissible stresses of the tank structures should not exceed that given in 4.23.3.1 (UI GC8A). (2.4.1)

4.23.9.2.4.2 Bending and local stresses may be read from the top and bottom surfaces of elements. Practical experience suggests that the allowable stresses for FE stress check of type C tank may be simplified using the following equations for the local area of structural discontinuities:

- $\sigma_{eL_membrane} \leq 1.5f$
- $\sigma_{eL_surface} \leq 1.5f$
- $\sigma_{eL_surface} \leq 3.0f$ (for containing self-limiting stresses, such as thermal stress)

In addition, for tank testing condition, using the following equation:

- $\sigma_{e_membrane} \leq 0.9R_e$

where

$\sigma_{eL_membrane}$ is element equivalent stress derived from the stress components of the membrane stress for the local area of structural discontinuities.

$\sigma_{eL_surface}$ is element equivalent stress derived from the stress components of the top and bottom surfaces for the local area of structural discontinuities, whichever is greater.

$\sigma_{e_membrane}$ is element equivalent stress derived from the stress components of the membrane stress at any point. See 4.23.6.1 (IGC Code 4.23.6.1).

f See 4.23.3.1 (IGC Code 4.23.3.1).

R_e Yield stress of the material considered, see 4.18.1.3 (IGC Code 4.18.1.3).

Note: For solid elements, the membrane and surface stress components are taken as per 2.2.3. (2.4.2)

4.23.9.3 Buckling strength assessment by non-linear finite element analysis (3)**4.23.9.3.1 General (3.1)**

4.23.9.3.1.1 The prescriptive formulas described in 4.23.3.1 (the UI GC8B) are applicable to the cylindrical and spherical parts of single cylinder or multi-lobe shape tanks which are not influenced by structural discontinuities such as Y-connections. (3.1.1)

4.23.9.3.1.2 The critical buckling pressure may also be determined by bifurcation buckling analysis using linear elastic stress analysis without geometric non-linearities and imperfections. In such cases, the cylindrical and spherical parts of single cylinder or multi-lobe shape tanks which are not influenced by structural discontinuities should be assessed with the criteria given below.

$$\frac{P_{cEI}}{P_e} \geq 4 \text{ for cylindrical shell}$$

$$\frac{P_{cEI}}{P_e} \geq 15 \text{ for spherical shell}$$

where:

P_{cEI} = critical buckling pressure obtained from eigenvalue analysis, in MPa

P_e = external design pressure, in MPa

Buckling strength assessments of remaining parts should be specially considered further. When applicable, all the possible load cases including axisymmetric and non-axisymmetric load scenarios should be considered. (3.1.2)

4.23.9.3.1.3 Alternatively, non-linear finite element analysis may be carried out for further assessment of the entire tank using elastic-plastic material behaviour with explicit imperfections (see 3.4 below), and with the criteria given below.

$$\frac{P_{c,NL}}{P_e} \geq 2 \text{ for cylindrical shell}$$

$$\frac{P_{c,NL}}{P_e} \geq 3^* \text{ for spherical shell}$$

where:

$P_{c,NL}$ = critical buckling pressure obtained from nonlinear analysis, in MPa

P_e = external design pressure, in MPa

- * For spherical shell, a lower safety factor but not less than 2 is to be agreed by the Society. In such a case, a lower safety factor can be used, provided it is proven by the benchmark study deemed appropriate by the Society.

Additional safety factor may also be applied under the judgment of Classification Society. (3.1.3)

4.23.9.3.2 Procedure for non-linear finite element analysis (3.2)

4.23.9.3.2.1 Figure 6 shows an overview of the non-linear analysis process. The detailed procedure should be ascertained in advance in consultation with each Classification Society. (3.2.1)

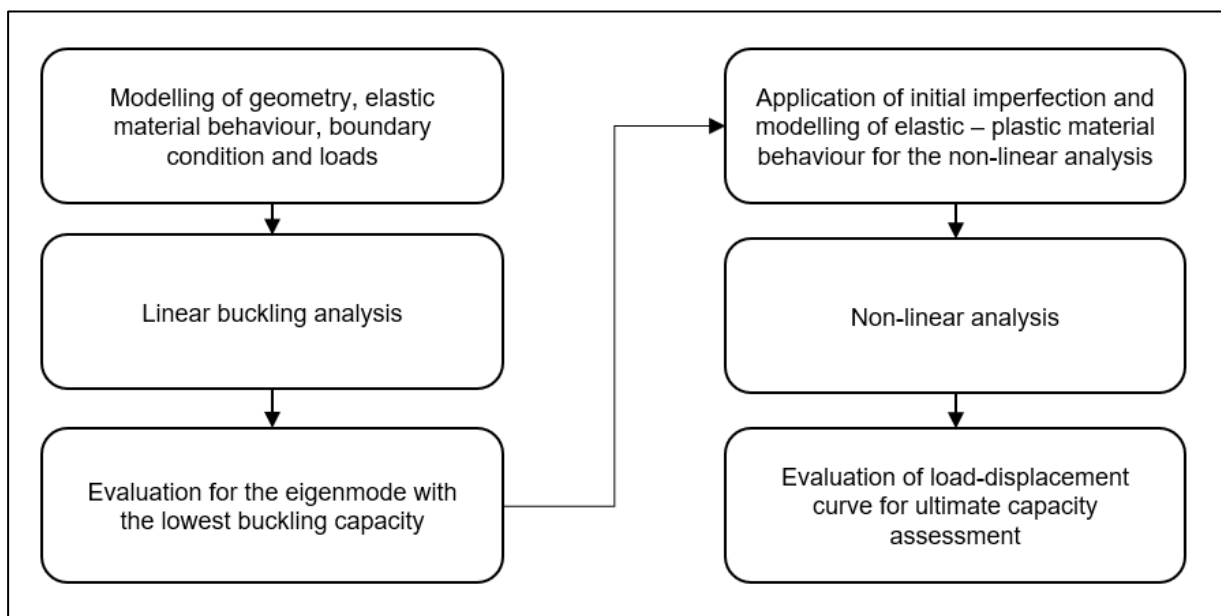

Figure 6 Flow chart for non-linear finite element analysis

4.23.9.3.3 Modelling (3.3)

4.23.9.3.3.1 The mesh size should be fine enough to simulate the relevant localised deformation of failure mode appropriately. Also, 2D shell elements are acceptable for the analysis. It is recommended as much as possible to use 4-node elements with aspect ratio not greater than 2. Examples are shown in Figure 7 and Figure 8. (3.3.1)

4.23.9.3.3.2 Type C tanks are generally made up of a combination of a cylindrical body with stiffening rings and spherical shells. It is recommended to evaluate the buckling capacity using the full model including both cylindrical and spherical shell components as well as stiffening rings. Simply supported ends are acceptable as a boundary condition.

However, if the location of the buckling is away from the boundary conditions and the distorted stresses induced by the boundary conditions are proven negligible, then it is possible to evaluate it through a partial model. (3.3.2)

4.23.9.3.3.3 In general, as the spherical shell has a higher buckling capacity than the cylindrical shell, most of the vulnerable parts appear in the cylindrical shell when evaluating the buckling capacity using the entire model. In addition, the openings, which are initially designed with a sufficiently large strength compared to the tank itself, and saddle structures are not required to be modelled in the buckling evaluation. (3.3.3)

4.23.9.3.4 Initial imperfection (3.4)

4.23.9.3.4.1 For conventional type C tanks generally made of cylindrical body with stiffening rings and spherical shells, initial imperfection such as out of roundness occurs due to mechanical processing or welding in the manufacturing process.

The maximum allowable imperfection should be considered in the assessment in accordance with Classification Society's requirement or recognized standard such as EN 13445. (3.4.1)

4.23.9.3.4.2 Where the shape and size of the initial imperfection may not be available, the buckling mode of n^{th} order with the lowest buckling capacity should be used as an initial imperfection shape as shown in Figure 6. The magnitude of the imperfection should take into account the manufacture and workmanship tolerances specified by Classification Societies or accepted manufacture standard. (3.4.2)

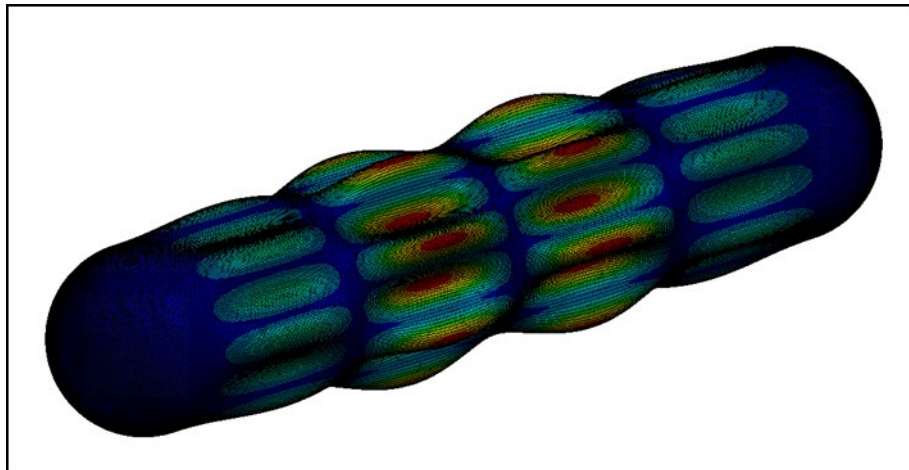

Figure 7 Linear buckling mode of typical single cylinder tank

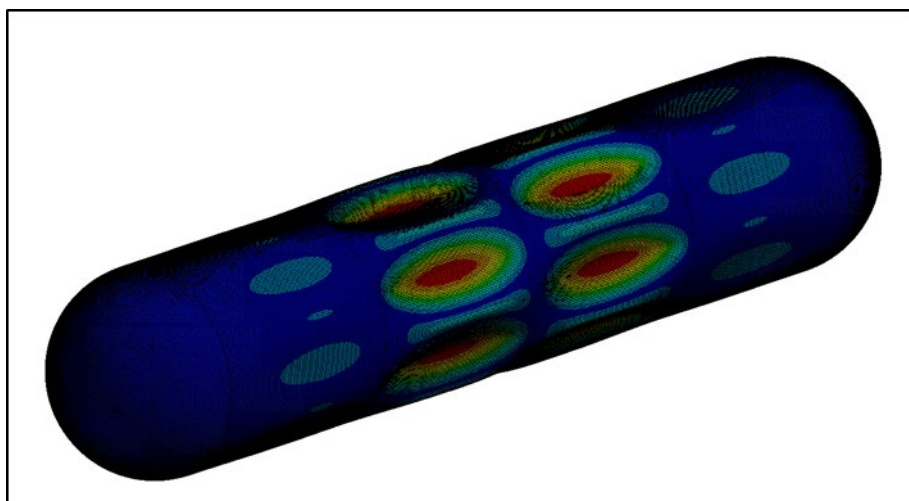

Figure 8 Deformation of typical single cylinder tank under collapse pressure

4.23.9.3.5 Load-displacement curve for assessment (3.5)

4.23.9.3.5.1 In order to obtain the maximum buckling capacity, the load-displacement curve from the non-linear finite element analysis should be evaluated. The buckling capacity should be conservatively determined considering the stable capacity level, which may be below the highest, yet unstable, limit point as shown in Figure 9. (3.5.1)

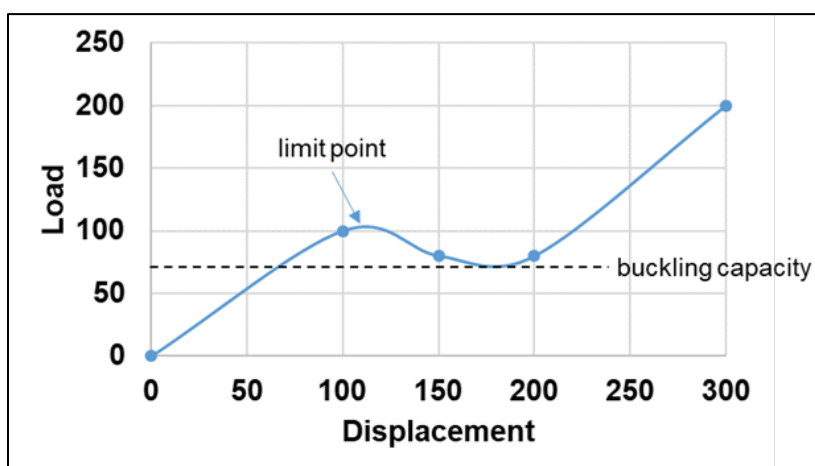

Figure 9 Load-displacement curve

4.23.9.4 Fatigue strength assessment (4)

4.23.9.4.1 Objectives and scope (4.1)

4.23.9.4.1.1 The prescriptive formula for design vapour pressure as defined in 4.23.1.2 (IGC Code 4.23.1.2) is intended to provide a simple design method to ensure sufficient fatigue strength capacity without further detailed finite element analysis.

However, for larger tanks or tanks with more complex designs, the prescriptive formula does not take into account the stresses occurred at local hot spots and support interactions. It may be required to document the tank design with finite element analysis for such cases. (4.1.1)

4.23.9.4.1.2 The following locations of multi-lobe tank should be evaluated for fatigue performance. Figure 10 to 12 show the location where high dynamic stresses may be expected.

- Tank shell in way of supports
- Tank joint connections between cylinders and their longitudinal bulkhead (Y-joint)
- Support ring frames
- High stressed locations identified by the ULS FE calculation (4.1.2)

4.23.9.4.1.3 This document offers basic guidelines for a simplified fatigue assessment. Alternative methods also may be applied in consultation with each Classification Society. (4.1.3)

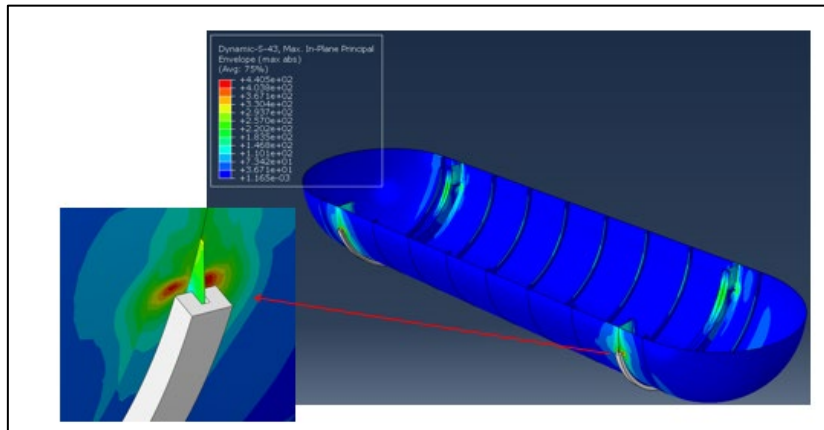

Figure 10 High dynamic stress at the interface with saddle support

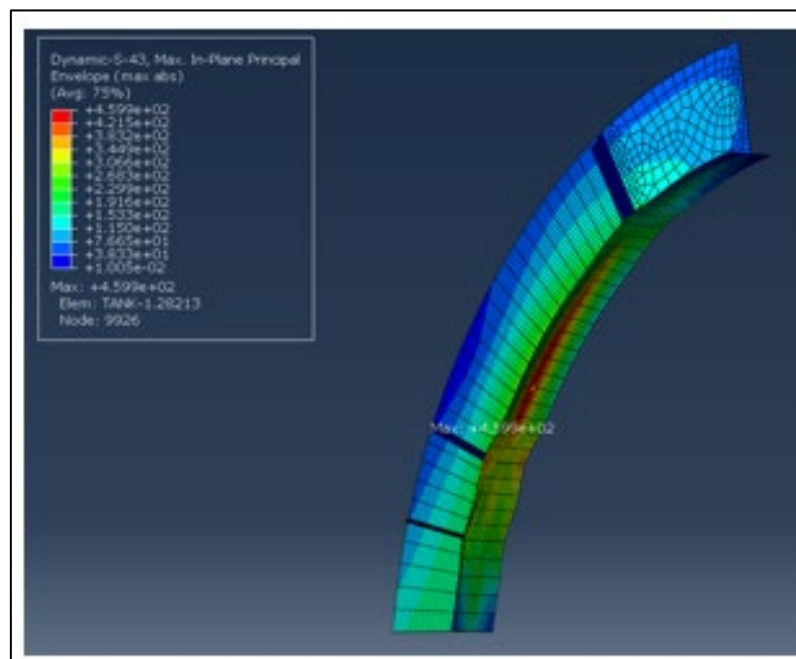

Figure 11 High dynamic stress at the stiffening ring frame

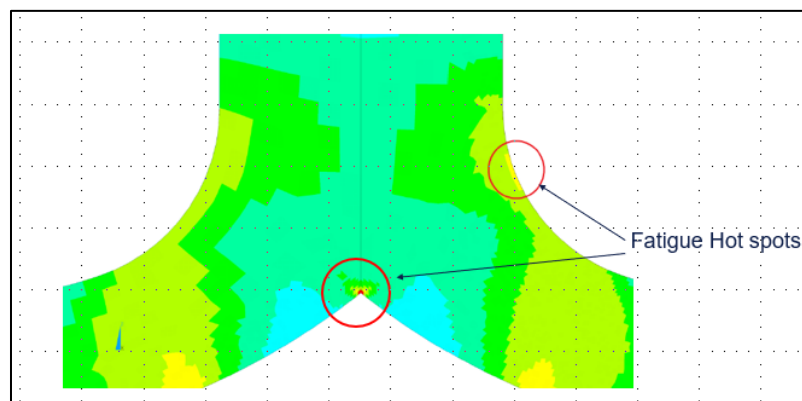

Figure 12 High dynamic stress at the Y-connection of bi-lobe tank

4.23.9.4.2 Modelling (4.2)

4.23.9.4.2.1 The finite element model will depend on configuration and arrangement of tanks and supports. In addition, the design temperature of the tank may affect the way how the tank is modelled. A few typical tank design applications are as follows:

- Single cylinder tanks on a typical saddle support with arrangement of wooden block between tank and saddle
- Single cylinder tanks with arrangement of vacuum insulated outer jacket – the support between inner tank and outer jacket is a fully welded type design
- Single cylinder tanks with arrangement of vacuum insulated outer jacket – the support between inner tank and outer jacket is made by contact blocks
- Multi-lobe tanks (4.2.1)

4.23.9.4.2.2 Finite element model should in principle be in accordance with 4.23.9.2.2 (Section 2.2). However, fatigue calculations require a finer mesh than normally required by the ULS calculations. (4.2.2)

4.23.9.4.2.3 The local finite element models should include fine mesh zones for the evaluation of hot spot stresses in way of areas of stress concentration. The fine mesh zones should cover all potential fatigue check areas.

The mesh size in way of the fine mesh zone should be taken as close to $t \times t$ as possible, where t is the thickness of the plate where crack is likely to initiate. The extent of the fine mesh zone, in the principal direction of the stress leading to maximum stress concentration at the detail, should be in order of at least 10 times the plate thickness, so that a realistic stress gradient toward the hotspot is correctly and realistically modelled. (4.2.3)

4.23.9.4.2.4 It is recommended to use 8-node shell element or 4-node shell elements with additional internal degree of freedom, and with the mesh size of $t \times t$ in the high stressed area, where t denotes plate thickness. (4.2.4)

4.23.9.4.2.5 The welding geometry can be modelled in local areas to investigate the hot spot stress. If necessary, 20 node quadratic solid elements are recommended to be used.

It is recommended that also the fillet weld is modelled to achieve proper local stiffness and geometry (See Figure 13). In such cases, the dimensions of the first two or three elements in front of the weld toe should be chosen as follows.

The element length may be selected to correspond to the plate thickness (See 4.2.6). In the perpendicular direction, the plate thickness may be chosen again for the breadth of the plate elements.

However, the breadth should not exceed the attachment width, i.e. the thickness of the attached plate plus two times the weld leg length. The length of the elements should be limited to $2.0 t$ (See Figure14). (4.2.5)

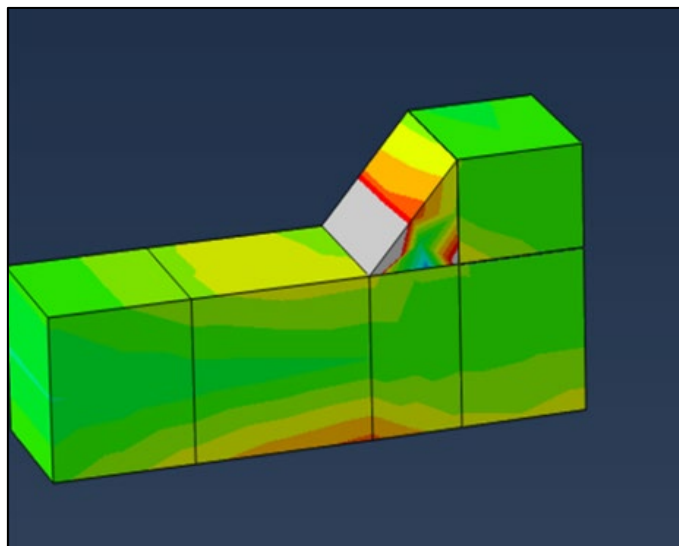

Figure13 A section of a plate, weld and an attachment modelled by 20-node solid elements

4.23.9.4.2.6 Mesh around hot spots: The mesh size should be maintained within the hot spot mesh zone (see Figure 14), extending over at least 10 elements in all directions from the fatigue hot spot position.

The transition of element size between the coarser mesh and the hot spot mesh zone should be done gradually and an acceptable mesh quality should be maintained. This transition mesh should be such that a uniform mesh with regular shape gradually transitions from smaller elements to larger ones. As a guidance mesh incremental size should be about 1:2. (4.2.6)

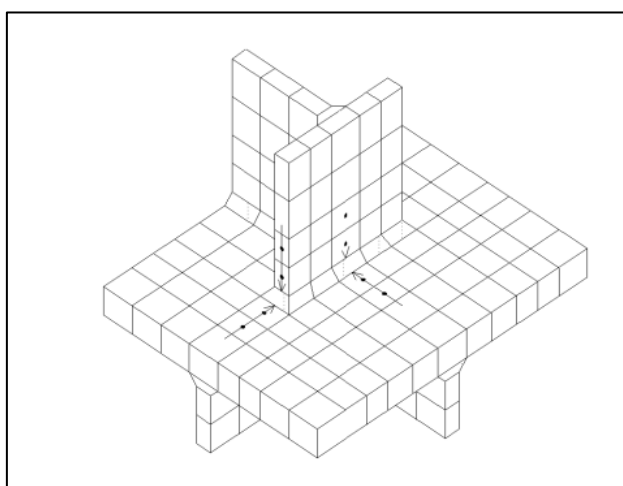

Figure 14 Example of a meshed geometry close to hotspot area based on 20-node solid elements

4.23.9.4.3 Design load (4.3)

4.23.9.4.3.1 The load cases defined in Table 7 should be considered to determine dynamic stress range for the high cycle fatigue utilisation. The stress response is advised to be determined based on the accelerations at 10^{-4} probability level. For fatigue evaluations the dynamic stress range at the local hotspot is to be determined based on the load cases defined in Table 7.

As the stress response for a type C tank is often non-linear due to contact elements and affected by deflections from static loads and thermal effects, the load cases will need to include all these effects correctly. However, the static stresses will need to be deducted or filtered away to extract the dynamic stress range. Load cases in Table 7 shall, in addition to the dynamic load component, include all static load components including relative shrinkage due to thermal loads.

It should also be noted that the recommended acceleration probability level of 10^{-4} is selected primarily based on the relative deflexions between tank and supports (geometrical non-linearity) to define a stress response that is representative for the fatigue utilisation. (4.3.1)

Table 7 Load combinations for high cycle fatigue load cases

Load case ID	Description	Permanent loads	Functional loads			Environment loads
			Filling level	Internal pressure	Thermal load ³⁾	Loads due to ship motion
LD1	Positive longitudinal acceleration	Gravity	Full	$P_{eq}^{1)}$	Minimum design temperature	$+a_x^{2)}$
LD2	Negative longitudinal acceleration	Gravity	Full	$P_{eq}^{1)}$	Minimum design temperature	$-a_x^{2)}$
TD1	Positive transverse acceleration	Gravity	Full	$P_{eq}^{1)}$	Minimum design temperature	$+a_y^{2)}$
TD2	Negative transverse acceleration	Gravity	Full	$P_{eq}^{1)}$	Minimum design temperature	$-a_y^{2)}$
VD1	Positive vertical acceleration	Gravity	Full	$P_{eq}^{1)}$	Minimum design temperature	$+a_z^{2)}$
VD2	Negative vertical acceleration	Gravity	Full	$P_{eq}^{1)}$	Minimum design temperature	$-a_z^{2)}$

¹⁾ Internal pressure as defined in 4.13.2.4 (IGC Code 4.13.2.4).

²⁾ Accelerations at 10^{-4} probability level in longitudinal, transverse and vertical directions. Accelerations may be determined based on 4.28.2.1 (the IGC Code 4.28.2.1). Direct calculation may be considered in accordance with 4.14.1.3 (IGC Code 4.14.1.3).

³⁾ Minimum design cargo temperature is given for tank. IGC condition may be assumed as it is a more representative ambient temperature for normal operation. Applicable temperature gradient for the saddle supports can be separately considered.

4.23.9.4.3.2 A fully loaded condition and empty tank condition cycle, including a complete pressure and thermal cycle should be assumed for low cycle fatigue utilisation. The number of stresses cycles due to loading and unloading should be taken as a minimum of 1000. (4.3.2)

4.23.9.4.4 Stress calculation (4.4)

4.23.9.4.4.1 Linear extrapolation to stress at hotspots should be based on stress evaluation points located at distances $t/2$ and $3 \cdot t/2$ away from the hot spot, where t is the plate thickness at the weld toe (See Figure 15).

These locations are also denoted as stress read out points. The extrapolation method is regarded as the basic method but read out at $t/2$ with stress correction is often regarded more convenient for many standard details (See Figure 15).

For read out at $0.5t$ from hotspot an additional stress concentration should be considered to be added to compensate for use of this method. A commonly used stress concentration factor is 1.12, unless other value is documented. (4.4.1)

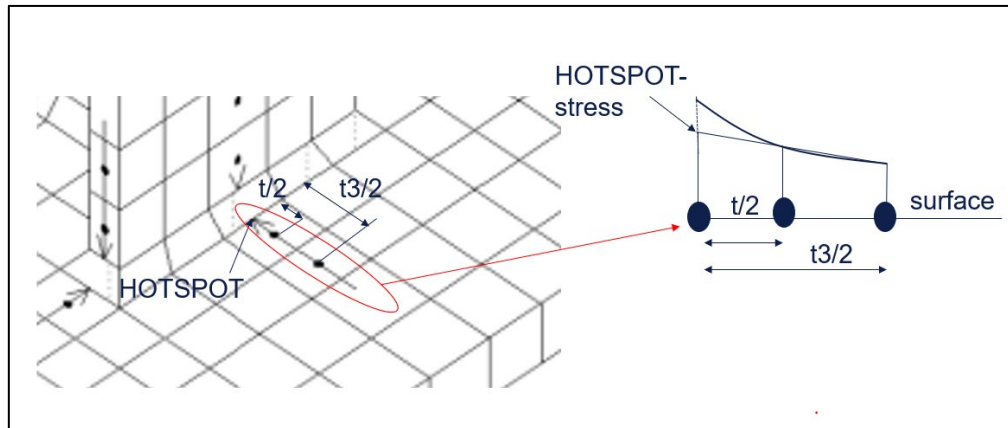

Figure 15 Illustration of stress interpolation for solid elements

4.23.9.4.4.2 The stresses at the location, where the fatigue performance is evaluated, should first be extrapolated to the surface of the plate then to the hot spot.

The extrapolation technique should be used with care as it can be non-conservative with large local stress variation. The extraction of principal stress range which is selected within $\pm 45^\circ$ of the normal to the weld toe should be used for the analysis. (4.4.2)

4.23.9.4.5 Determination of stress range from load cases (4.5)

4.23.9.4.5.1 The stress ranges for longitudinal, transverse and vertical load cases should be calculated from the hot spot stress response described in 4.4.1 and 4.4.2 of the six load cases as defined in Table 7.

$$\Delta\sigma_x = \sigma(+x) - \sigma(-x)$$

where:

$\Delta\sigma_x$ = Stress range for accelerations in longitudinal direction

$\sigma(+x)$ = Principal stress amplitude from load case LD1

$\sigma(-x)$ = Principal stress amplitude from load case LD2

$$\Delta\sigma_y = \sigma(+y) - \sigma(-y)$$

where:

$\Delta\sigma_y$ = Stress range for accelerations in transverse direction

$\sigma(+y)$ = Principal stress amplitude from load case TD1

$\sigma(-y)$ = Principal stress amplitude from load case TD2

$$\Delta\sigma_z = \sigma(+z) - \sigma(-z)$$

where:

$\Delta\sigma_z$ = Stress range for accelerations in vertical direction

$\sigma(+z)$ = Principal stress amplitude from load case VD1

$\sigma(-z)$ = Principal stress amplitude taken from load case VD2 (4.5.1)

4.23.9.4.5.2 The combined stress range ($\Delta\sigma_A$) determined based on all three load directions can be calculated as a root square summation based on the assumption that each stress component is statistically independent of the other load components. The combined stress range can accordingly be determined as:

$$\Delta\sigma_A = \sqrt{\Delta\sigma_x^2 + \Delta\sigma_y^2 + \Delta\sigma_z^2} \quad (4.5.2)$$

4.23.9.4.5.3 Where appropriate, additional stress concentration factors to account for construction qualities and plate thickness effects may need to be applied. (4.5.3)

4.23.9.4.5.4 For simplified fatigue assessment, long term distribution of stress may be assumed to follow a two-parameter Weibull distribution. The stress range may be distributed over 10^8 cycles according to Weibull probability function with shape factor 1,0. (4.5.4)

4.23.9.4.6 S-N Curves (4.6)

4.23.9.4.6.1 The fatigue damage should be calculated using S-N curves and the Miner-Palmgren linear cumulative fatigue damage law. (4.6.1)

4.23.9.4.6.2 In principle, the fatigue S-N curves should be derived from experimental data obtained from tests. 4.18.2 Fatigue Design Condition (IGC Code 4.18.2 Fatigue Design Condition) requires that the S-N curves used in the analysis shall be applicable to the materials and weldments, construction details, fabrication procedures and applicable stress envisioned.

The curves also shall be based on 97.6% probability of survival corresponding to the mean-minus-two-standard-deviation curves of relevant experimental data up to final failure. The S-N curves complying with these requirements should be used as design S-N curves. (4.6.2)

4.23.9.4.6.3 The design S-N curve for concerned materials should be taken in accordance with recognised standards or equivalent acceptable to each Classification Society. (4.6.3)

4.23.9.4.7 Acceptance criteria (4.7)

4.23.9.4.7.1 If a fatigue analysis is required, the cumulative effect of the load should comply with:

$$\sum \frac{n_i}{N_i} + \frac{n_{\text{Loading}}}{N_{\text{Loading}}} \leq C_w$$

where:

n_i = number of stress cycles at each stress level during the life of the tank

N_i = number of cycles to fracture for the respective stress level according to the Wohler (S-N) curve

n_{Loading} = number of loading and unloading cycles during the life of the tank, not to be less than 1000. Loading and unloading cycles include a complete pressure and thermal cycle;

N_{Loading} = number of cycles to fracture for the fatigue loads due to loading and unloading

C_w = maximum allowable cumulative fatigue damage ratio (4.7.1)

4.23.9.4.7.2 The maximum allowable cumulative fatigue damage ratio should not exceed that of 4.23.3.1 (UI GC8C). (4.7.2)

END OF IACS REC 174

4.24 Membrane tanks

4.24.1 Design basis

4.24.1.1 The design basis for membrane containment systems is that thermal and other expansion or contraction is compensated for without undue risk of losing the tightness of the membrane.

4.24.1.2 A systematic approach based on analysis and testing shall be used to demonstrate that the system will provide its intended function in consideration of the events identified in service as specified in 4.24.2.1.

4.24.1.3 If the cargo temperature at atmospheric pressure is below -10°C , a complete secondary barrier shall be provided as required in 4.5. The secondary barrier shall be designed according to 4.6.

4.24.1.4 The design vapour pressure P_o shall not normally exceed 0.025 MPa. If the hull scantlings are increased accordingly and consideration is given, where appropriate, to the strength of the supporting thermal insulation, P_o may be increased to a higher value, but less than 0.07 MPa.

4.24.1.5 The definition of membrane tanks does not exclude designs such as those in which non-metallic membranes are used or where membranes are included or incorporated into the thermal insulation.

4.24.1.6 The thickness of the membranes shall not normally exceed 10 mm.

4.24.1.7 The circulation of inert gas throughout the primary insulation space and the secondary insulation space, in accordance with 9.2.1, shall be sufficient to allow for effective means of gas detection.

4.24.2 Design considerations

4.24.2.1 Potential incidents that could lead to loss of fluid tightness over the life of the membranes shall be evaluated. These include, but are not limited to:

- .1 Ultimate design events:
 - .1 tensile failure of membranes;
 - .2 compressive collapse of thermal insulation;
 - .3 thermal ageing;
 - .4 loss of attachment between thermal insulation and hull structure;
 - .5 loss of attachment of membranes to thermal insulation system;
 - .6 structural integrity of internal structures and their supporting structures; and
 - .7 failure of the supporting hull structure.
- .2 Fatigue design events:
 - .1 fatigue of membranes including joints and attachments to hull structure;
 - .2 fatigue cracking of thermal insulation;
 - .3 fatigue of internal structures and their supporting structures; and
 - .4 fatigue cracking of inner hull leading to ballast water ingress.
- .3 Accident design events:
 - .1 accidental mechanical damage (such as dropped objects inside the tank while in service);
 - .2 accidental overpressurization of thermal insulation spaces;
 - .3 accidental vacuum in the tank; and

.4 water ingress through the inner hull structure.

Designs where a single internal event could cause simultaneous or cascading failure of both membranes are unacceptable.

4.24.2.2 The necessary physical properties (mechanical, thermal, chemical, etc.) of the materials used in the construction of the cargo containment system shall be established during the design development in accordance with 4.24.1.2.

4.24.3 *Loads and load combinations*

Particular consideration shall be given to the possible loss of tank integrity due to either an overpressure in the interbarrier space, a possible vacuum in the cargo tank, the sloshing effects, hull vibration effects, or any combination of these events.

4.24.4 *Structural analyses*

4.24.4.1 Structural analyses and/or testing for the purpose of determining the ultimate strength and fatigue assessments of the cargo containment and associated structures, e.g. structures as defined in 4.9, shall be performed. The structural analysis shall provide the data required to assess each failure mode that has been identified as critical for the cargo containment system.

4.24.4.2 Structural analyses of the hull shall take into account the internal pressure as indicated in 4.13.2. Special attention shall be paid to deflections of the hull and their compatibility with the membrane and associated thermal insulation.

4.24.4.3 The analyses referred to in 4.24.4.1 and 4.24.4.2 shall be based on the particular motions, accelerations and response of ships and cargo containment systems.

4.24.5 *Ultimate design condition*

4.24.5.1 The structural resistance of every critical component, subsystem or assembly shall be established, in accordance with 4.24.1.2, for in-service conditions.

4.24.5.2 The choice of strength acceptance criteria for the failure modes of the cargo containment system, its attachments to the hull structure and internal tank structures, shall reflect the consequences associated with the considered mode of failure.

4.24.5.3 The inner hull scantlings shall meet the requirements for deep tanks, taking into account the internal pressure as indicated in 4.13.2 and the specified appropriate requirements for sloshing load as defined in 4.14.3.

4.24.6 *Fatigue design condition*

4.24.6.1 Fatigue analysis shall be carried out for structures inside the tank, i.e. pump towers, and for parts of membrane and pump tower attachments, where failure development cannot be reliably detected by continuous monitoring.

4.24.6.2 The fatigue calculations shall be carried out in accordance with 4.18.2, with relevant requirements depending on:

- .1** the significance of the structural components with respect to structural integrity; and
- .2** availability for inspection.

4.24.6.3 For structural elements for which it can be demonstrated by tests and/or analyses that a crack will not develop to cause simultaneous or cascading failure of both membranes, C_w shall be less than or equal to 0.5.

4.24.6.4 Structural elements subject to periodic inspection, and where an unattended fatigue crack can develop to cause simultaneous or cascading failure of both membranes, shall satisfy the fatigue and fracture mechanics requirements stated in 4.18.2.8.

4.24.6.5 Structural element not accessible for in-service inspection, and where a fatigue crack can develop without warning to cause simultaneous or cascading failure of both membranes, shall satisfy the fatigue and fracture mechanics requirements stated in 4.18.2.9.

4.24.7 Accident design condition

4.24.7.1 The containment system and the supporting hull structure shall be designed for the accidental loads specified in 4.15. These loads need not be combined with each other or with environmental loads.

4.24.7.2 Additional relevant accident scenarios shall be determined based on a risk analysis. Particular attention shall be paid to securing devices inside tanks.

4.24.8 Design development testing

4.24.8.1 The design development testing required in 4.24.1.2 shall include a series of analytical and physical models of both the primary and secondary barriers, including corners and joints, tested to verify that they will withstand the expected combined strains due to static, dynamic and thermal loads. This will culminate in the construction of a prototype-scaled model of the complete cargo containment system. Testing conditions considered in the analytical and physical models shall represent the most extreme service conditions the cargo containment system will be likely to encounter over its life. Proposed acceptance criteria for periodic testing of secondary barriers required in 4.6.2 may be based on the results of testing carried out on the prototype-scaled model.

4.24.8.2 The fatigue performance of the membrane materials and representative welded or bonded joints in the membranes shall be determined by tests. The ultimate strength and fatigue performance of arrangements for securing the thermal insulation system to the hull structure shall be determined by analyses or tests.

4.24.9 Testing

4.24.9.1 In ships fitted with membrane cargo containment systems, all tanks and other spaces that may normally contain liquid and are adjacent to the hull structure supporting the membrane, shall be hydrostatically tested.

4.24.9.2 All hold structures supporting the membrane shall be tested for tightness before installation of the cargo containment system.

4.24.9.3 Pipe tunnels and other compartments that do not normally contain liquid need not be hydrostatically tested.

4.25 Integral tanks

4.25.1 Design basis

Integral tanks that form a structural part of the hull and are affected by the loads that stress the adjacent hull structure shall comply with the following:

- .1 the design vapour pressure P_o as defined in 4.1.2 shall not normally exceed 0.025 MPa. If the hull scantlings are increased accordingly, P_o may be increased to a higher value, but less than 0.07 MPa;
- .2 integral tanks may be used for products, provided the boiling point of the cargo is not below -10°C . A lower temperature may be accepted by the Administration or recognized organization acting on its behalf subject to special consideration, but in such cases a complete secondary barrier shall be provided; and
- .3 products required by Chapter 19 to be carried in type 1G ships shall not be carried in integral tanks.

4.25.2 Structural analysis

The structural analysis of integral tanks shall be in accordance with recognized standards.

4.25.3 Ultimate design condition

4.25.3.1 The tank boundary scantlings shall meet the requirements for deep tanks, taking into account the internal pressure as indicated in 4.13.2.

4.25.3.2 For integral tanks, allowable stresses shall normally be those given for hull structure in the requirements of the Administration or recognized organization acting on its behalf.

4.25.4 Accident design condition

4.25.4.1 The tanks and the tank supports shall be designed for the accidental loads specified in 4.3.4.3 and 4.15, as relevant.

4.25.4.2 When subjected to the accidental loads specified in 4.15, the stress shall comply with the acceptance criteria specified in 4.25.3, modified as appropriate, taking into account their lower probability of occurrence.

4.25.5 Testing

All integral tanks shall be hydrostatically or hydropneumatically tested. The test shall be performed so that the stresses approximate, as far as practicable, to the design stresses and that the pressure at the top of the tank corresponds at least to the MARVS.

4.26 Semi-membrane tanks

4.26.1 Design basis

4.26.1.1 Semi-membrane tanks are non-self-supporting tanks when in the loaded condition and consist of a layer, parts of which are supported through thermal insulation by the adjacent hull structure, whereas the rounded parts of this layer connecting the above-mentioned supported parts are designed also to accommodate the thermal and other expansion or contraction.

4.26.1.2 The design vapour pressure P_o shall not normally exceed 0.025 MPa. If the hull scantlings are increased accordingly, and consideration is given, where appropriate, to the strength of the supporting thermal insulation, P_o may be increased to a higher value, but less than 0.07 MPa.

4.26.1.3 For semi-membrane tanks the relevant requirements in this section for independent tanks or for membrane tanks shall be applied as appropriate.

4.26.1.4 In the case of semi-membrane tanks that comply in all respects with the requirements applicable to type B independent tanks, except for the manner of support, the Administration may, after special consideration, accept a partial secondary barrier.

Part F

CARGO CONTAINMENT SYSTEMS OF NOVEL CONFIGURATION

4.27 Limit state design for novel concepts

4.27.1 Cargo containment systems that are of a novel configuration that cannot be designed using sections 4.21 to 4.26 shall be designed using this section and parts A and B of this Chapter, and also parts C and D, as applicable. Cargo containment system design according to this section shall be based on the principles of limit state design which is an approach to structural design that can be applied to established design solutions as well as novel designs. This more generic approach maintains a level of safety similar to that achieved for known containment systems as designed using 4.21 to 4.26.

4.27.2 Limit state design approach

4.27.2.1 The limit state design is a systematic approach where each structural element is evaluated with respect to possible failure modes related to the design conditions identified in 4.3.4. A limit state can be defined as a condition beyond which the structure, or part of a structure, no longer satisfies the requirements.

4.27.2.2 For each failure mode, one or more limit states may be relevant. By consideration of all relevant limit states, the limit load for the structural element is found as the minimum limit load resulting from all the relevant limit states. The limit states are divided into the three following categories:

- .1 Ultimate limit states (ULS), which correspond to the maximum load-carrying capacity or, in some cases, to the maximum applicable strain or deformation; under intact (undamaged) conditions.
- .2 Fatigue limit states (FLS), which correspond to degradation due to the effect of time varying (cyclic) loading.
- .3 Accident limit states (ALS), which concern the ability of the structure to resist accidental situations.

4.27.3 The procedure and relevant design parameters of the limit state design shall comply with the Standards for the Use of limit state methodologies in the design of cargo containment systems of novel configuration (LSD Standard), as set out in Appendix 5.

Part G

GUIDANCE

4.28 Guidance notes for Chapter 4

Note:

Provisions of section 4.28 serve as guidance and information only – see 1.1.12.

4.28.1 *Guidance to detailed calculation of internal pressure for static design purpose*

4.28.1.1 This section provides guidance for the calculation of the associated dynamic liquid pressure for the purpose of static design calculations. This pressure may be used for determining the internal pressure referred to in 4.13.2.4, where:

- .1 $(P_{gd})_{\max}$ is the associated liquid pressure determined using the maximum design accelerations.
- .2 $(P_{gd \text{ site}})_{\max}$ is the associated liquid pressure determined using site specific accelerations.

.3 P_{eq} should be the greater of P_{eq1} and P_{eq2} calculated as follows:

$$P_{eq1} = P_o + (P_{gd})_{\max} \quad (\text{MPa}),$$

$$P_{eq2} = P_h + (P_{gd \text{ site}})_{\max} \quad (\text{MPa}).$$

4.28.1.2 The internal liquid pressures are those created by the resulting acceleration of the centre of gravity of the cargo due to the motions of the ship referred to in 4.14.1. The value of internal liquid pressure P_{gd} resulting from combined effects of gravity and dynamic accelerations should be calculated as follows:

$$P_{gd} = a_{\beta} Z_{\beta} \frac{\rho}{1.02 \times 10^5} \quad (\text{MPa})$$

where:

a_{β} = dimensionless acceleration (i.e. relative to the acceleration of gravity), resulting from gravitational and dynamic loads, in an arbitrary direction β (see figure 4.1). For large tanks, an acceleration ellipsoid taking account of transverse vertical and longitudinal accelerations, should be used.

Z_{β} = largest liquid height (m) above the point where the pressure is to be determined measured from the tank shell in the β direction (see figure 4.2)

Tank domes considered to be part of the accepted total tank volume shall be taken into account when determining Z_{β} , unless the total volume of tank domes V_d does not exceed the following value:

$$V_d = V_t \left(\frac{100 - FL}{FL} \right)$$

with:

V_t = tank volume without any domes; and

FL = filling limit according to Chapter 15.

ρ = maximum cargo density (kg/m³) at the design temperature.

The direction that gives the maximum value $(P_{gd})_{\max}$ or $(P_{gd \text{ site}})_{\max}$ should be considered.

The above formula applies only to full tanks.

4.28.1.3 Equivalent calculation procedures may be applied.

4.28.2 Guidance formulae for acceleration components

4.28.2.1 The following formulae are given as guidance for the components of acceleration due to ship's motions corresponding to a probability level of 10⁻⁸ in the North Atlantic and apply to ships with a length exceeding 50 m and at or near their service speed:

– vertical acceleration, as defined in 4.14.1:

$$a_z = \pm a_0 \sqrt{1 + \left(5.3 - \frac{45}{L_0}\right)^2 \left(\frac{x}{L_0} + 0.05\right)^2 \left(\frac{0.6}{C_B}\right)^{1.5} + \left(\frac{0.6yK^{1.5}}{B}\right)^2},$$

– transverse acceleration, as defined in 4.14.1:

$$a_y = \pm a_0 \sqrt{0.6 + 2.5 \left(\frac{x}{L_0} + 0.05\right)^2 + K \left(1 + 0.6K \frac{Z}{B}\right)^2},$$

– longitudinal acceleration, as defined in 4.14.1:

$$a_x = \pm a_0 \sqrt{0.06 + A^2 - 0.25A} ,$$

where:

$$a_0 = 0.2 \frac{V}{\sqrt{L_0}} + \frac{34 - \left(\frac{600}{L_0}\right)}{L_0}$$

L_0 = length of the ship for determination of scantlings as defined in recognized standards (m);

C_B = block coefficient;

B = greatest moulded breadth of the ship (m);

x = longitudinal distance (m) from amidships to the centre of gravity of the tank with contents; x is positive forward of amidships, negative aft of amidships;

y = transverse distance (m) from centreline to the centre of gravity of the tank with contents;

z = vertical distance (m) from the ship's actual waterline to the centre of gravity of tank with contents; z is positive above and negative below the waterline;

K = 1 in general. For particular loading conditions and hull forms, determination of K according to the following formula may be necessary:

K = $13GM/B$, where $K \geq 1$ and GM = metacentric height (m);

$$A = \left(0.7 - \frac{L_0}{1200} + 5 \frac{z}{L_0}\right) \left(\frac{0.6}{C_B}\right); \text{ and}$$

V = service speed (knots);

a_x, a_y, a_z = maximum dimensionless accelerations (i.e. relative to the acceleration of gravity) in the respective directions. They are considered as acting separately for calculation purposes, and a_z does not include the component due to the static weight, a_y includes the component due to the static weight in the transverse direction due to rolling and a_x includes the component due to the static weight in the longitudinal direction due to pitching. The accelerations derived from the above formulae are applicable only to ships at or near their service speed, not while at anchor or otherwise near stationary in exposed locations.

4.28.3 Stress categories

4.28.3.1 For the purpose of stress evaluation, stress categories are defined in this section as follows.

4.28.3.2 Normal stress is the component of stress normal to the plane of reference.

4.28.3.3 Membrane stress is the component of normal stress that is uniformly distributed and equal to the average value of the stress across the thickness of the section under consideration.

4.28.3.4 Bending stress is the variable stress across the thickness of the section under consideration, after the subtraction of the membrane stress.

4.28.3.5 Shear stress is the component of the stress acting in the plane of reference.

4.28.3.6 Primary stress is a stress produced by the imposed loading, which is necessary to balance the external forces and moments. The basic characteristic of a primary stress is that it is not self-limiting. Primary stresses that considerably exceed the yield strength will result in failure or at least in gross deformations.

4.28.3.7 Primary general membrane stress is a primary membrane stress that is so distributed in the structure that no redistribution of load occurs as a result of yielding.

4.28.3.8 Primary local membrane stress arises where a membrane stress produced by pressure or other mechanical loading and associated with a primary or a discontinuity effect produces excessive distortion in the transfer of loads for other portions of the structure. Such a stress is classified as a primary local membrane stress, although it has some characteristics of a secondary stress. A stress region may be considered as local, if:

$$S_1 \leq 0.5\sqrt{Rt} \quad \text{and}$$

$$S_2 \leq 2.5\sqrt{Rt},$$

where:

- S_1 = distance in the meridional direction over which the equivalent stress exceeds $1.1f$;
- S_2 = distance in the meridional direction to another region where the limits for primary general membrane stress are exceeded;
- R = mean radius of the vessel;
- t = wall thickness of the vessel at the location where the primary general membrane stress limit is exceeded; and
- f = allowable primary general membrane stress.

4.28.3.9 Secondary stress is a normal stress or shear stress developed by constraints of adjacent parts or by self-constraint of a structure. The basic characteristic of a secondary stress is that it is self-limiting. Local yielding and minor distortions can satisfy the conditions that cause the stress to occur.

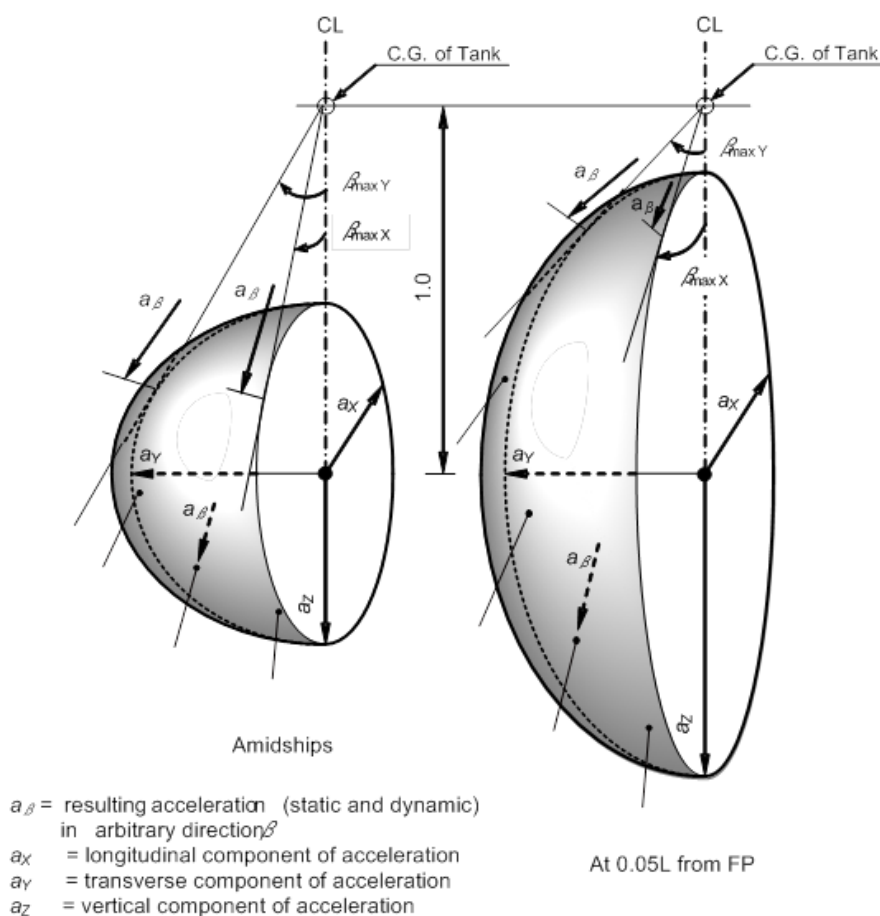

Figure 4.1 – Acceleration ellipsoid

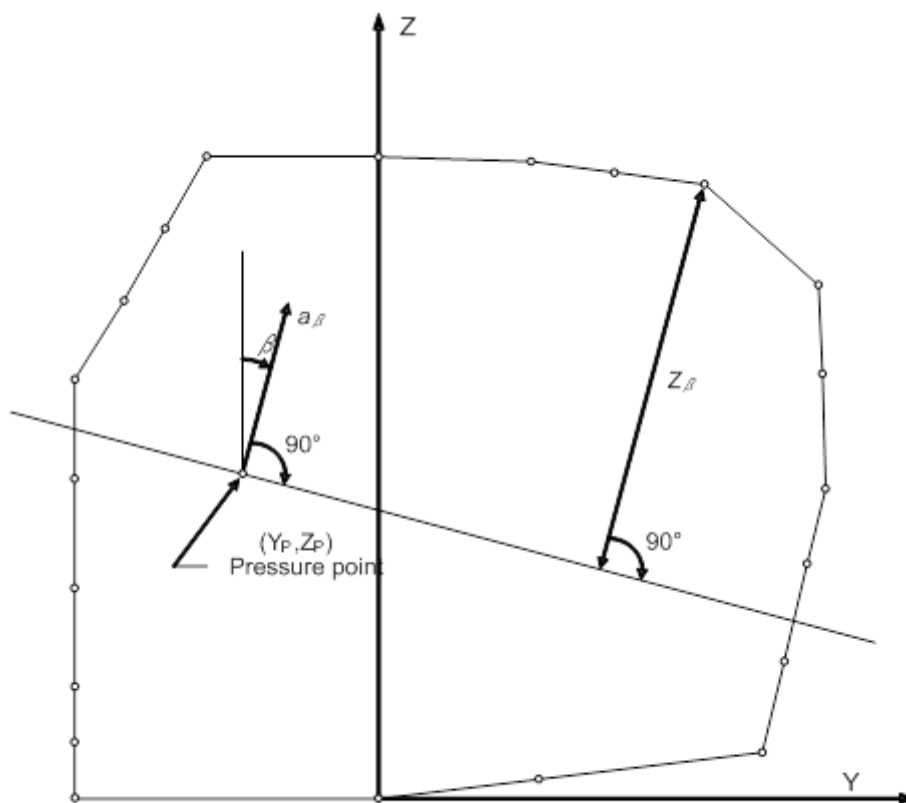

Figure 4.2 – Determination of internal pressure heads

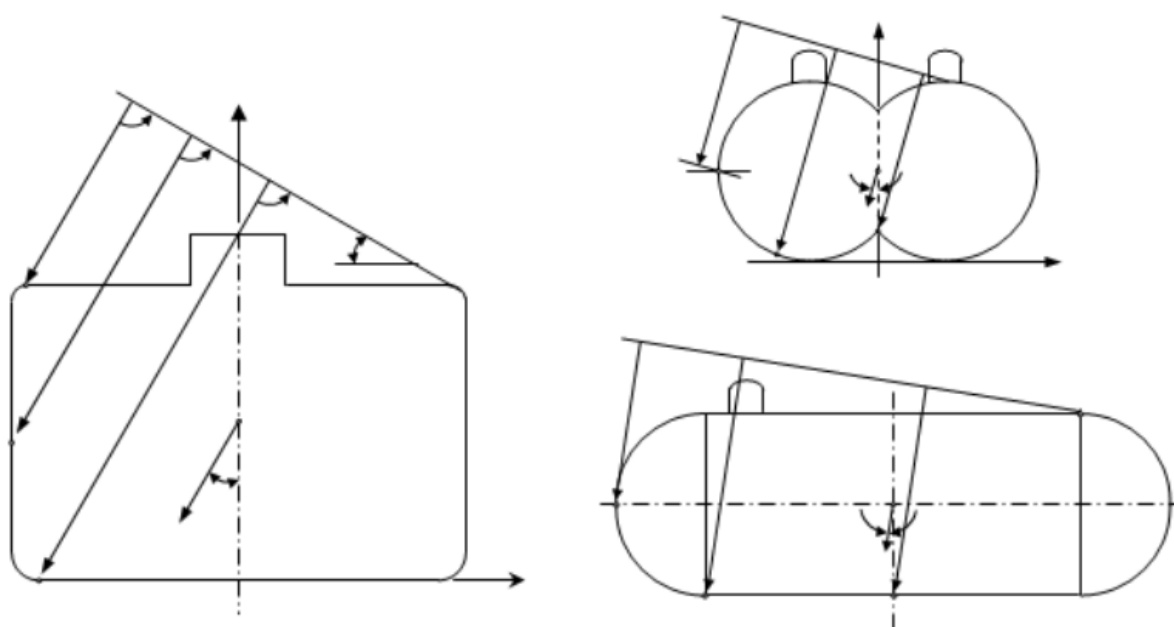
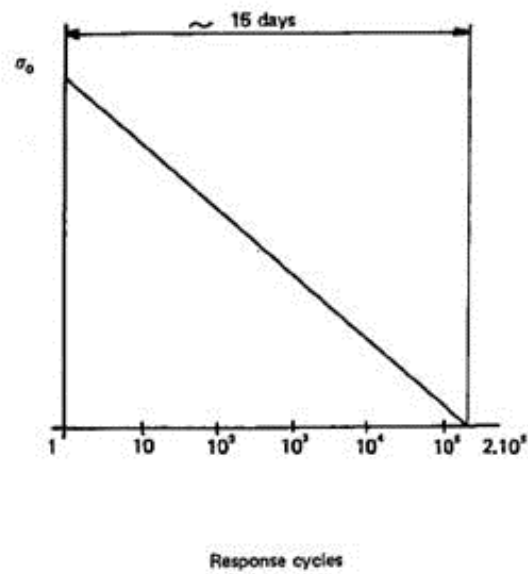

Figure 4.3 – Determination of liquid height Z_{β} for points 1, 2 and 3



σ_0 = most probable maximum stress over the life of the ship
Response cycle scale is logarithmic; the value of $2 \cdot 10^5$ is given as an example of estimate.

Figure 4.4 – Simplified load distribution

CHAPTER 5

(IGC Code Chapter 5)

Goal

To ensure the safe handling of all cargo and process liquid and vapour, under all operating conditions, to minimize the risk to the ship, crew and to the environment, having regard to the nature of the products involved. This will:

- .1 ensure the integrity of process pressure vessels, piping systems and cargo hoses;
- .2 prevent the uncontrolled transfer of cargo;
- .3 ensure reliable means to fill and empty the containment systems; and
- .4 prevent pressure or vacuum excursions of cargo containment systems, beyond design parameters, during cargo transfer operations.

5 PROCESS PRESSURE VESSELS AND LIQUID, VAPOUR AND PRESSURE PIPING SYSTEMS**5.1 General**

5.1.1 The requirements of this Chapter shall apply to products and process piping, including vapour piping, gas fuel piping and vent lines of safety valves or similar piping. Auxiliary piping systems not containing cargo are exempt from the general requirements of this Chapter.

5.1.2 The requirements for type C independent tanks provided in Chapter 4 may also apply to process pressure vessels. If so required, the term "pressure vessels" as used in Chapter 4, covers both type C independent tanks and process pressure vessels.

5.1.3 Process pressure vessels include surge tanks, heat exchangers and accumulators that store or treat liquid or vapour cargo.

5.2 System requirements

5.2.1 The cargo handling and cargo control systems shall be designed taking into account the following:

- .1 prevention of an abnormal condition escalating to a release of liquid or vapour cargo;
- .2 the safe collection and disposal of cargo fluids released;
- .3 prevention of the formation of flammable mixtures;
- .4 prevention of ignition of flammable liquids or gases and vapours released; and
- .5 limiting the exposure of personnel to fire and other hazards.

5.2.2 Arrangements: general

5.2.2.1 Any piping system that may contain cargo liquid or vapour shall:

- .1 be segregated from other piping systems, except where interconnections are required for cargo-related operations such as purging, gas-freeing or inerting. The requirements of 9.4.4 shall be taken into account with regard to preventing back-flow of cargo. In such cases, precautions shall be taken to ensure that cargo or cargo vapour cannot enter other piping systems through the interconnections;
- .2 except as provided in Chapter 16, not pass through any accommodation space, service space or control station or through a machinery space other than a cargo machinery space;
- .3 be connected to the cargo containment system directly from the weather decks except where pipes installed in a vertical trunkway or equivalent are used to traverse void spaces above a cargo containment system and except where pipes for drainage, venting or purging traverse cofferdams;

- .4 be located in the cargo area above the weather deck except for bow or stern loading and unloading arrangements in accordance with 3.8, emergency cargo jettisoning piping systems in accordance with 5.3.1, turret compartment systems in accordance with 5.3.3 and except in accordance with Chapter 16; and
- .5 be located inboard of the transverse tank location requirements of 2.4.1, except for athwartship shore connection piping not subject to internal pressure at sea or emergency cargo jettisoning piping systems.

5.2.2.2 Suitable means shall be provided to relieve the pressure and remove liquid cargo from loading and discharging crossover headers; likewise, any piping between the outermost manifold valves and loading arms or cargo hoses to the cargo tanks, or other suitable location, prior to disconnection.

5.2.2.3 Piping systems carrying fluids for direct heating or cooling of cargo shall not be led outside the cargo area unless a suitable means is provided to prevent or detect the migration of cargo vapour outside the cargo area (see 13.6.2.6).

5.2.2.4 Relief valves discharging liquid cargo from the piping system shall discharge into the cargo tanks. Alternatively, they may discharge to the cargo vent mast, if means are provided to detect and dispose of any liquid cargo that may flow into the vent system. Where required to prevent overpressure in downstream piping, relief valves on cargo pumps shall discharge to the pump suction.

5.3 Arrangements for cargo piping outside the cargo area

5.3.1 *Emergency cargo jettisoning*

If fitted, an emergency cargo jettisoning piping system shall comply with 5.2.2, as appropriate, and may be led aft, external to accommodation spaces, service spaces or control stations or machinery spaces, but shall not pass through them. If an emergency cargo jettisoning piping system is permanently installed, a suitable means of isolating the piping system from the cargo piping shall be provided within the cargo area.

5.3.2 *Bow and stern loading arrangements*

5.3.2.1 Subject to the requirements of 3.8, this section and 5.10.1, cargo piping may be arranged to permit bow or stern loading and unloading.

5.3.2.2 Arrangements shall be made to allow such piping to be purged and gas-freed after use. When not in use, the spool pieces shall be removed and the pipe ends blank-flanged. The vent pipes connected with the purge shall be located in the cargo area.

5.3.3 *Turret compartment transfer systems*

For the transfer of liquid or vapour cargo through an internal turret arrangement located outside the cargo area, the piping serving this purpose shall comply with 5.2.2, as applicable, 5.10.2 and the following:

- .1 piping shall be located above the weather deck, except for the connection to the turret;
- .2 portable arrangements shall not be permitted; and
- .3 arrangements shall be made to allow such piping to be purged and gas-freed after use. When not in use, the spool pieces for isolation from the cargo piping shall be removed and the pipe ends blank-flanged. The vent pipes connected with the purge shall be located in the cargo area.

5.3.4 Gas fuel piping systems

Gas fuel piping in machinery spaces shall comply with all applicable sections of this Chapter in addition to the requirements of Chapter 16.

5.4 Design pressure

Note:

See also 5.14.3.2.

5.4.1 The design pressure P_o , used to determine minimum scantlings of piping and piping system components, shall be not less than the maximum gauge pressure to which the system may be subjected in service. The minimum design pressure used shall not be less than 1 MPa gauge, except for open-ended lines or pressure relief valve discharge lines, where it shall be not less than the lower of 0.5 MPa gauge, or 10 times the relief valve set pressure.

5.4.2 The greater of the following design conditions shall be used for piping, piping systems and components, based on the cargoes being carried:

- .1 for vapour piping systems or components that may be separated from their relief valves and which may contain some liquid, the saturated vapour pressure at a design temperature of 45°C. Higher or lower values may be used (see 4.13.2.2); or
- .2 for systems or components that may be separated from their relief valves and which contain only vapour at all times, the superheated vapour pressure at 45°C. Higher or lower values may be used (see 4.13.2.2), assuming an initial condition of saturated vapour in the system at the system operating pressure and temperature; or
- .3 the MARVS of the cargo tanks and cargo processing systems; or
- .4 the pressure setting of the associated pump or compressor discharge relief valve; or
- .5 the maximum total discharge or loading head of the cargo piping system considering all possible pumping arrangements or the relief valve setting on a pipeline system.

5.4.3 Those parts of the liquid piping systems that may be subjected to surge pressures shall be designed to withstand this pressure.

5.4.4 The design pressure of the outer pipe or duct of gas fuel systems shall not be less than the maximum working pressure of the inner gas pipe. Alternatively, for gas fuel piping systems with a working pressure greater than 1 MPa, the design pressure of the outer duct shall not be less than the maximum built-up pressure arising in the annular space considering the local instantaneous peak pressure in way of any rupture and the ventilation arrangements.

IACS interpretation

Outer Duct in Gas Fuel Piping Systems

1. The expression "duct" in 5.4.4 and 5.13.2.4 means to include the equipment enclosure required in 16.4.3.1 and 16.4.3.2 (e.g. Gvu enclosure) as well as the structural pipe duct intended to contain any release of gas from inner pipe or equipment. The term "structural pipe duct" means an outer duct forming part of a structure such as a hull structure or superstructure or deck house, where permitted, other than gas valve unit rooms.

The gas valve unit rooms are to be:

- .1 gastight toward other enclosed spaces;
 - .2 equipped with mechanical exhaust ventilation having a capacity of at least 30 air changes per hour and arranged to maintain a pressure less than the atmospheric pressure; and
 - .3 able to withstand the maximum built-up pressure arising in the room in case of a gas pipe rupture, as documented by suitable calculations taking into account the ventilation arrangements.
- 2 The expression "design pressure of the outer pipe or duct" in 5.4.4 is either of the following:
- .1 the maximum pressure that can act on the outer pipe or equipment enclosure after the inner pipe rupture as documented by suitable calculations taking into account the venting arrangements; or

- .2 for gas fuel systems with inner pipe working pressure greater than 1 MPa, the "maximum built-up pressure arising in the annular space", after the inner pipe rupture, which is to be calculated in accordance with paragraph 9.8.2 of the IGF Code as adopted by MSC.391(95).*
- 3. The expression "maximum pressure at gas pipe rupture" in 5.13.2.4 is the maximum pressure to which the outer pipe or duct is subjected after the inner pipe rupture and for testing purposes it is the same as the design pressure used in 5.4.4. (IACS UI GC32)*

5.5 Cargo system valve requirements

5.5.1.1 Every cargo tank and piping system shall be fitted with manually operated valves for isolation purposes as specified in this section.

5.5.1.2 In addition, remotely operated valves shall also be fitted, as appropriate, as part of the emergency shutdown (ESD) system the purpose of which is to stop cargo flow or leakage in the event of an emergency when cargo liquid or vapour transfer is in progress. The ESD system is intended to return the cargo system to a safe static condition so that any remedial action can be taken. Due regard shall be given in the design of the ESD system to avoid the generation of surge pressures within the cargo transfer pipework. The equipment to be shut down on ESD activation includes manifold valves during loading or discharge, any pump or compressor, etc., transferring cargo internally or externally (e.g. to shore or another ship/barge) and cargo tank valves, if the MARVS exceeds 0.07 MPa.

5.5.2 Cargo tank connections

5.5.2.1 All liquid and vapour connections, except for safety relief valves and liquid level gauging devices, shall have shutoff valves located as close to the tank as practicable. These valves shall provide full closure and shall be capable of local manual operation. They may also be capable of remote operation.

5.5.2.2 For cargo tanks with a MARVS exceeding 0.07 MPa gauge, the above connections shall also be equipped with remotely controlled ESD valves. These valves shall be located as close to the tank as practicable. A single valve may be substituted for the two separate valves, provided the valve complies with the requirements of 18.10.2 and provides full closure of the line.

5.5.3 Cargo manifold connections

5.5.3.1 One remotely controlled ESD valve shall be provided at each cargo transfer connection in use to stop liquid and vapour transfer to or from the ship. Transfer connections not in use shall be isolated with suitable blank flanges.

5.5.3.2 If the cargo tank MARVS exceeds 0.07 MPa, an additional manual valve shall be provided for each transfer connection in use, and may be inboard or outboard of the ESD valve to suit the ship's design.

5.5.4 Excess flow valves may be used in lieu of ESD valves, if the diameter of the protected pipe does not exceed 50 mm. Excess flow valves shall close automatically at the rated closing flow of vapour or liquid as specified by the manufacturer. The piping including fittings, valves and appurtenances protected by an excess flow valve shall have a capacity greater than the rated closing flow of the excess flow valve. Excess flow valves may be designed with a bypass not exceeding the area of a 1 mm diameter circular opening to allow equalization of pressure after a shutdown activation.

5.5.5 Cargo tank connections for gauging or measuring devices need not be equipped with excess flow valves or ESD valves, provided that the devices are constructed so that the outward flow of tank contents cannot exceed that passed by a 1.5 mm diameter circular hole.

5.5.6 All pipelines or components which may be isolated in a liquid full condition shall be protected with relief valves for thermal expansion and evaporation.

5.5.7 All pipelines or components which may be isolated automatically due to a fire with a liquid volume of more than 0.05 m³ entrapped shall be provided with PRVs sized for a fire condition.

5.6 Cargo transfer arrangements

5.6.1 Where cargo transfer is by means of cargo pumps that are not accessible for repair with the tanks in service, at least two separate means shall be provided to transfer cargo from each cargo tank, and the design shall be such that failure of one cargo pump or means of transfer will not prevent the cargo transfer by another pump or pumps, or other cargo transfer means.

5.6.2 The procedure for transfer of cargo by gas pressurization shall preclude lifting of the relief valves during such transfer. Gas pressurization may be accepted as a means of transfer of cargo for those tanks where the design factor of safety is not reduced under the conditions prevailing during the cargo transfer operation. If the cargo tank relief valves or set pressure are changed for this purpose, as it is permitted in accordance with 8.2.7 and 8.2.8, the new set pressure shall not exceed P_h as is defined in 4.13.2.

5.6.3 Vapour return connections

Connections for vapour return to the shore installations shall be provided.

5.6.4 Cargo tank vent piping systems

The pressure relief system shall be connected to a vent piping system designed to minimize the possibility of cargo vapour accumulating on the decks, or entering accommodation spaces, service spaces, control stations and machinery spaces, or other spaces where it may create a dangerous condition.

5.6.5 Cargo sampling connections

IACS and IMO interpretation

Cargo Sampling

These requirements are only applicable if such a sampling system is fitted on board. Connections used for control of atmosphere in cargo tanks during inerting or gassing up are not considered as cargo sampling connections. (IACS UI GC33, MSC.1/Circ.1625)

5.6.5.1 Connections to cargo piping systems for taking cargo liquid samples shall be clearly marked and shall be designed to minimize the release of cargo vapours. For vessels permitted to carry toxic products, the sampling system shall be of a closed loop design to ensure that cargo liquid and vapour are not vented to atmosphere.

5.6.5.2 Liquid sampling systems shall be provided with two valves on the sample inlet. One of these valves shall be of the multi-turn type to avoid accidental opening, and shall be spaced far enough apart to ensure that they can isolate the line if there is blockage, by ice or hydrates for example.

5.6.5.3 On closed loop systems, the valves on the return pipe shall also comply with 5.6.5.2.

5.6.5.4 The connection to the sample container shall comply with recognized standards and be supported so as to be able to support the weight of a sample container. Threaded connections shall be tack-welded, or otherwise locked, to prevent them being unscrewed during the normal connection and disconnection of sample containers. The sample connection shall be fitted with a closure plug or flange to prevent any leakage when the connection is not in use.

5.6.5.5 Sample connections used only for vapour samples may be fitted with a single valve in accordance with 5.5, 5.8 and 5.13, and shall also be fitted with a closure plug or flange.

5.6.5.6 (...)

5.6.6 Cargo filters

The cargo liquid and vapour systems shall be capable of being fitted with filters to protect against damage by extraneous objects. Such filters may be permanent or temporary, and the standards of filtration shall be appropriate to the risk of debris, etc., entering the cargo system. Means shall be provided to indicate that filters are becoming blocked, and to isolate, depressurize and clean the filters safely.

IACS and IMO interpretation

Cargo Filters

Means to indicate that filters are becoming blocked and filter maintenance is required is to be provided for fixed in-line filter arrangement and portable filter installations where dedicated filter housing piping is provided.

Where portable filters for fitting to manifold presentation flanges are used without dedicated filter housing, and these can be visually inspected after each loading and discharging operation, no additional arrangements for indicating blockage or facilitating drainage are required. (IACS UI GC34, MSC.1/Circ.1625)

5.7 Installation requirements

5.7.1 Design for expansion and contraction

Provision shall be made to protect the piping, piping system and components and cargo tanks from excessive stresses due to thermal movement and from movements of the tank and hull structure. The preferred method outside the cargo tanks is by means of offsets, bends or loops, but multi-layer bellows may be used if offsets, bends or loops are not practicable.

5.7.2 Precautions against low temperature

Low temperature piping shall be thermally isolated from the adjacent hull structure, where necessary, to prevent the temperature of the hull from falling below the design temperature of the hull material. Where liquid piping is dismantled regularly, or where liquid leakage may be anticipated, such as at shore connections and at pump seals, protection for the hull beneath shall be provided.

5.7.3 Water curtain

For cargo temperatures below -110°C, a water distribution system shall be fitted in way of the hull under the shore connections to provide a low-pressure water curtain for additional protection of the hull steel and the ship's side structure. This system is in addition to the requirements of 11.3.1.4, and shall be operated when cargo transfer is in progress.

5.7.4 Bonding

Where tanks or cargo piping and piping equipment are separated from the ship's structure by thermal isolation, provision shall be made for electrically bonding both the piping and the tanks.

All gasketed pipe joints and hose connections shall be electrically bonded. Except where bonding straps are used, it shall be demonstrated that the electrical resistance of each joint or connection is less than 1M Ω .

5.8 Piping fabrication and joining details

5.8.1 General

Note:

See also 5.14.7.1.

The requirements of this section apply to piping inside and outside the cargo tanks. Relaxation from these requirements may be accepted, in accordance with recognized standards for piping inside cargo tanks and open-ended piping.

5.8.2 Direct connections

Note:

See also 5.14.7.2.

The following direct connection of pipe lengths, without flanges, may be considered:

- .1 butt-welded joints with complete penetration at the root may be used in all applications. For design temperatures colder than -10°C, butt welds shall be either double welded or equivalent to a double welded butt joint. This may be accomplished by use of a backing ring, consumable insert or inert gas backup on the first pass. For design pressures in excess of 1 MPa and design temperatures of -10°C or colder, backing rings shall be removed;
- .2 slip-on welded joints with sleeves and related welding, having dimensions in accordance with recognized standards, shall only be used for instrument lines and open-ended lines with an external diameter of 50 mm or less and design temperatures not colder than -55°C; and
- .3 screwed couplings complying with recognized standards shall only be used for accessory lines and instrumentation lines with external diameters of 25 mm or less.

5.8.3 Flanged connections

Note:

See also 5.14.7.3.

5.8.3.1 Flanges in flanged connections shall be of the welded neck, slip-on or socket welded type.

5.8.3.2 Flanges shall comply with recognized standards for their type, manufacture and test. For all piping, except open ended, the following restrictions apply:

- .1 for design temperatures colder than -55°C, only welded-neck flanges shall be used; and
- .2 for design temperatures colder than -10°C, slip-on flanges shall not be used in nominal sizes above 100 mm and socket welded flanges shall not be used in nominal sizes above 50 mm.

5.8.4 Expansion joints

Note:

See also 5.14.7.5.

Where bellows and expansion joints are provided in accordance with 5.7.1, the following requirements apply:

- .1 if necessary, bellows shall be protected against icing; and
- .2 slip joints shall not be used except within the cargo tanks.

5.8.5 *Other connections*

Note: See also 5.14.7.4.

Piping connections shall be joined in accordance with 5.8.2 to 5.8.4, but for other exceptional cases the Administration may consider alternative arrangements.

5.9 **Welding, post-weld heat treatment and non-destructive testing**

Note: See also 5.14.7.6.

5.9.1 *General*

Welding shall be carried out in accordance with 6.5.

5.9.2 *Post-weld heat treatment*

Post-weld heat treatment shall be required for all butt welds of pipes made with carbon, carbon-manganese and low alloy steels. The Administration or recognized organization acting on its behalf may waive the requirements for thermal stress relieving of pipes with wall thickness less than 10 mm in relation to the design temperature and pressure of the piping system concerned.

5.9.3 *Non-destructive testing*

In addition to normal controls before and during the welding, and to the visual inspection of the finished welds, as necessary for proving that the welding has been carried out correctly and according to the requirements of this paragraph, the following tests shall be required:

- .1 100% radiographic or ultrasonic inspection of butt-welded joints for piping systems with design temperatures colder than -10°C , and with inside diameters of more than 75 mm, or wall thicknesses greater than 10 mm;
- .2 when such butt-welded joints of piping sections are made by automatic welding procedures approved by the Administration or recognized organization acting on its behalf, then a progressive reduction in the extent of radiographic or ultrasonic inspection can be agreed, but in no case to less than 10% of each joint. If defects are revealed, the extent of examination shall be increased to 100% and shall include inspection of previously accepted welds. This approval can only be granted if well-documented quality assurance procedures and records are available to assess the ability of the manufacturer to produce satisfactory welds consistently; and
- .3 for other butt-welded joints of pipes not covered by 5.9.3.1 and 5.9.3.2, spot radiographic or ultrasonic inspection or other non-destructive tests shall be carried out depending upon service, position and materials. In general, at least 10% of butt-welded joints of pipes shall be subjected to radiographic or ultrasonic inspection.

5.10 **Installation requirements for cargo piping outside the cargo area**

5.10.1 *Bow and stern loading arrangements*

The following requirements shall apply to cargo piping and related piping equipment located outside the cargo area:

- .1 cargo piping and related piping equipment outside the cargo area shall have only welded connections. The piping outside the cargo area shall run on the weather decks and shall be at least 0.8 m inboard, except for athwartships shore connection piping. Such piping shall be clearly identified and fitted with a shutoff valve at its connection to the cargo piping system within the cargo area. At this location, it shall also be capable of being separated by means of a removable spool piece and blank flanges, when not in use; and

- .2 the piping shall be full penetration butt-welded and subjected to full radiographic or ultrasonic inspection, regardless of pipe diameter and design temperature. Flange connections in the piping shall only be permitted within the cargo area and at the shore connection.

5.10.2 Turret compartment transfer systems

The following requirements shall apply to liquid and vapour cargo piping where it is run outside the cargo area:

- .1 cargo piping and related piping equipment outside the cargo area shall have only welded connections; and
- .2 the piping shall be full penetration butt-welded, and subjected to full radiographic or ultrasonic inspection, regardless of pipe diameter and design temperature. Flange connections in the piping shall only be permitted within the cargo area and at connections to cargo hoses and the turret connection.

5.10.3 Gas fuel piping

Gas fuel piping, as far as practicable, shall have welded joints. Those parts of the gas fuel piping that are not enclosed in a ventilated pipe or duct according to 16.4.3, and are on the weather decks outside the cargo area, shall have full penetration butt-welded joints and shall be subjected to full radiographic or ultrasonic inspection.

5.11 Piping system component requirements

5.11.1 General

5.11.1.1 Piping systems shall be designed in accordance with recognized standards.

Note: See also 5.14.3.1.

5.11.2 Piping scantlings

Note: See also 5.14.3.4.

5.11.2.1 The following criteria shall be used for determining pipe wall thickness.

5.11.2.2 The wall thickness of pipes shall not be less than:

$$t = \frac{t_0 + b + c}{1 - \frac{a}{100}} \quad (\text{mm})$$

where:

t_0 = theoretical thickness, determined by the following formula:

$$t_0 = \frac{PD}{2Ke + P} \quad (\text{mm})$$

with:

P = design pressure (MPa) referred to in 5.4;

D = outside diameter (mm);

K = allowable stress (N/mm²) referred to in 5.11.3;

e = efficiency factor equal to 1 for seamless pipes and for longitudinally or spirally welded pipes, delivered by approved manufacturers of welded pipes, that are considered equivalent to seamless pipes when non-destructive testing on welds is carried out in accordance with recognized standards. In other cases, an efficiency factor of less than 1, in accordance with recognized standards, may be required, depending on the manufacturing process;

b = allowance for bending (mm). The value of b shall be chosen so that the calculated stress in the bend, due to internal pressure only, does not exceed the allowable stress. Where such justification is not given, b shall be:

$$b = \frac{Dt_0}{2.5r} \quad (\text{mm})$$

with:

r = mean radius of the bend (mm);

c = corrosion allowance (mm). If corrosion or erosion is expected, the wall thickness of the piping shall be increased over that required by other design requirements. This allowance shall be consistent with the expected life of the piping; and

a = negative manufacturing tolerance for thickness (%).

5.11.2.3 The minimum wall thickness shall be in accordance with recognized standards.

5.11.2.4 Where necessary for mechanical strength to prevent damage, collapse, excessive sag or buckling of pipes due to superimposed loads, the wall thickness shall be increased over that required by 5.11.2.2 or, if this is impracticable or would cause excessive local stresses, these loads may be reduced, protected against or eliminated by other design methods. Such superimposed loads may be due to: supporting structures, ship deflections, liquid pressure surge during transfer operations, the weight of suspended valves, reaction to loading arm connections, or otherwise.

5.11.3 Allowable stress

Note: See also 5.14.3.3.

5.11.3.1 For pipes, the allowable stress K referred to in the formula in 5.11.2 is the lower of the following values:

$$\frac{R_m}{A} \quad \text{or} \quad \frac{R_e}{B}$$

where:

R_m = specified minimum tensile strength at room temperature (N/mm^2); and

R_e = specified minimum yield stress at room temperature (N/mm^2). If the stress-strain curve does not show a defined yield stress, the 0.2% proof stress applies.

The values of A and B shall be shown on the *International Certificate of Fitness for the Carriage of Liquefied Gases in Bulk* required in 1.4.4, and have values of at least $A = 2.7$ and $B = 1.8$.

5.11.4 High-pressure gas fuel outer pipes or ducting scantlings

Note: See also 5.14.3.4 d).

In fuel gas piping systems of design pressure greater than the critical pressure, the tangential membrane stress of a straight section of pipe or ducting shall not exceed the tensile strength divided by 1.5 ($R_m/1.5$) when subjected to the design pressure specified in 5.4. The pressure ratings of all other piping components shall reflect the same level of strength as straight pipes.

5.11.5 Stress analysis

Note: See also 5.14.4.

When the design temperature is -110°C or lower, a complete stress analysis, taking into account all the stresses due to the weight of pipes, including acceleration loads if significant, internal pressure, thermal contraction and loads induced by hog and sag of the ship for each branch of the piping system shall be submitted to the Administration. For temperatures above -110°C , a stress

analysis may be required by the Administration in relation to such matters as the design or stiffness of the piping system and the choice of materials. In any case, consideration shall be given to thermal stresses even though calculations are not submitted. The analysis may be carried out according to a code of practice acceptable to the Administration.

5.11.6 *Flanges, valves and fittings*

Note: See also 5.14.3.5.

5.11.6.1 Flanges, valves and other fittings shall comply with recognized standards, taking into account the material selected and the design pressure defined in 5.4. For bellows expansion joints used in vapour service, a lower minimum design pressure may be accepted.

5.11.6.2 For flanges not complying with a recognized standard, the dimensions of flanges and related bolts shall be to the satisfaction of the Administration or recognized organization acting on its behalf.

5.11.6.3 All emergency shutdown valves shall be of the "fail-closed" type (see 5.13.1.1 and 18.10.2).

5.11.6.4 The design and installation of expansion bellows shall be in accordance with recognized standards and be fitted with means to prevent damage due to over-extension or compression.

5.11.7 *Ship's cargo hoses*

5.11.7.1 Liquid and vapour hoses used for cargo transfer shall be compatible with the cargo and suitable for the cargo temperature.

5.11.7.2 Hoses subject to tank pressure, or the discharge pressure of pumps or vapour compressors, shall be designed for a bursting pressure not less than five times the maximum pressure the hose will be subjected to during cargo transfer.

5.11.7.3 Each new type of cargo hose, complete with end-fittings, shall be prototype-tested at a normal ambient temperature, with 200 pressure cycles from zero to at least twice the specified maximum working pressure. After this cycle pressure test has been carried out, the prototype test shall demonstrate a bursting pressure of at least 5 times its specified maximum working pressure at the upper and lower extreme service temperature. Hoses used for prototype testing shall not be used for cargo service. Thereafter, before being placed in service, each new length of cargo hose produced shall be hydrostatically tested at ambient temperature to a pressure not less than 1.5 times its specified maximum working pressure, but not more than two fifths of its bursting pressure. The hose shall be stencilled, or otherwise marked, with the date of testing, its specified maximum working pressure and, if used in services other than ambient temperature services, its maximum and minimum service temperature, as applicable. The specified maximum working pressure shall not be less than 1 MPa gauge.

5.12 **Materials**

Note: See also 5.14.5.

5.12.1 The choice and testing of materials used in piping systems shall comply with the requirements of Chapter 6, taking into account the minimum design temperature. However, some relaxation may be permitted in the quality of material of open-ended vent piping, provided that the temperature of the cargo at the pressure relief valve setting is not lower than -55°C, and that no liquid discharge to the vent piping can occur. Similar relaxations may be permitted under the same temperature conditions to open-ended piping inside cargo tanks, excluding discharge piping and all piping inside membrane and semi-membrane tanks.

5.12.2 Materials having a melting point below 925°C shall not be used for piping outside the cargo tanks except for short lengths of pipes attached to the cargo tanks, in which case fire-resisting insulation shall be provided.

5.12.3 *Cargo piping insulation system*

Note: See also 5.14.9.

5.12.3.1 Cargo piping systems shall be provided with a thermal insulation system as required to minimize heat leak into the cargo during transfer operations and to protect personnel from direct contact with cold surfaces.

IACS and IMO interpretation

Cargo piping insulation

The expression 'a thermal insulation system as required to minimize heat leak into the cargo during transfer operations' means that properties of the piping insulation are to be taken into consideration when calculating the heat balance of the containment system and capacity of the pressure/temperature control system.

The expression 'cargo piping systems shall be provided with a thermal insulation system as required ... to protect personnel from direct contact with cold surfaces' means that surfaces of cargo piping systems with which personnel is likely to contact under normal conditions shall be protected by a thermal insulation, with the exception of the following examples:

- .1 surfaces of cargo piping systems which are protected by physical screening measures to prevent such direct contact;*
- .2 surfaces of manual valves, having extended spindles that protect the operator from the cargo temperature, and*
- .3 surfaces of cargo piping systems whose design temperature (to be determined from inner fluid temperature) is above minus 10 °C. (IACS UI GC25, MSC.1/Circ.1625)*

5.12.3.2 Where applicable, due to location or environmental conditions, insulation materials shall have suitable properties of resistance to fire and flame spread and shall be adequately protected against penetration of water vapour and mechanical damage.

5.12.4 Where the cargo piping system is of a material susceptible to stress corrosion cracking in the presence of a salt-laden atmosphere, adequate measures to avoid this occurring shall be taken by considering material selection, protection of exposure to salty water and/or readiness for inspection.

5.13 Testing requirements

5.13.1 *Type testing of piping components*

Note: For cargo pumps prototype and unit production testing – see 5.14.6.3.1 and 5.14.6.3.2.

5.13.1.1 Valves ⁷

⁷ Refer to SIGTTO Publication on "The Selection and Testing of Valves for LNG Applications"

Note: See also 5.14.6.1.

Each type of valve intended to be used at a working temperature below -55°C shall be subject to the following type tests:

- .1** each size and type of valve shall be subjected to seat tightness testing over the full range of operating pressures for bi-directional flow and temperatures, at intervals, up to the rated design pressure of the valve. Allowable leakage rates shall be to the requirements of the Administration or recognized organization acting on its behalf. During the testing, satisfactory operation of the valve shall be verified;
- .2** the flow or capacity shall be certified to a recognized standard for each size and type of valve;

IACS and IMO interpretation

The expression "Each type of valve...shall be certified to a recognized standard" is interpreted to mean that:

- .1 for pressure relief valves (PRVs) that are subject to 8.2.5 (IGC Code paragraph 8.2.5), the flow or capacity are to be certified by the Administration or Recognized Organization acting on its behalf; and
- .2 for other types of valves, the manufacturer is to certify the flow properties of the valves based on tests carried out according to recognized standards. (IACS UI GC26, MSC.1/Circ.1625)
- .3 pressurized components shall be pressure tested to at least 1.5 times the rated pressure; and
- .4 for emergency shutdown valves, with materials having melting temperatures lower than 925°C, the type testing shall include a fire test to a standard acceptable to the Administration.

IACS and IMO interpretation**Type testing requirements for valves**

"Emergency shutdown valves, with materials having melting temperatures lower than 925°C" does not include an emergency shutdown valves in which components made of materials having melting temperatures lower than 925°C do not contribute to the of shell or seat tightness of the valve. (IACS UI GC24, MSC.1/Circ.1606)

5.13.1.2 Expansion bellows

Note: See also 5.14.6.2.

The following type tests shall be performed on each type of expansion bellows intended for use on cargo piping outside the cargo tank and where required by the Administration or recognized organization acting on its behalf, on those installed within the cargo tanks:

- .1 elements of the bellows, not pre-compressed, shall be pressure tested at not less than five times the design pressure without bursting. The duration of the test shall not be less than 5 min;
- .2 a pressure test shall be performed on a type expansion joint, complete with all the accessories such as flanges, stays and articulations, at the minimum design temperature and twice the design pressure at the extreme displacement conditions recommended by the manufacturer, without permanent deformation;
- .3 a cyclic test (thermal movements) shall be performed on a complete expansion joint, which shall withstand at least as many cycles under the conditions of pressure, temperature, axial movement, rotational movement and transverse movement as it will encounter in actual service. Testing at ambient temperature is permitted when this testing is at least as severe as testing at the service temperature; and
- .4 a cyclic fatigue test (ship deformation) shall be performed on a complete expansion joint, without internal pressure, by simulating the bellows movement corresponding to a compensated pipe length, for at least 2,000,000 cycles at a frequency not higher than 5 Hz. This test is only required when, due to the piping arrangement, ship deformation loads are actually experienced.

5.13.2 System testing requirements

Note: See also 5.14.8.

5.13.2.1 The requirements of this section shall apply to piping inside and outside the cargo tanks.

5.13.2.2 After assembly, all cargo and process piping shall be subjected to a strength test with a suitable fluid. The test pressure shall be at least 1.5 times the design pressure (1.25 times the design pressure where the test fluid is compressible) for liquid lines and 1.5 times the maximum

system working pressure (1.25 times the maximum system working pressure where the test fluid is compressible) for vapour lines. When piping systems or parts of systems are completely manufactured and equipped with all fittings, the test may be conducted prior to installation on board the ship. Joints welded on board shall be tested to at least 1.5 times the design pressure.

5.13.2.3 After assembly on board, each cargo and process piping system shall be subjected to a leak test using air, or other suitable medium, to a pressure depending on the leak detection method applied.

5.13.2.4 In double wall gas-fuel piping systems, the outer pipe or duct shall also be pressure tested to show that it can withstand the expected maximum pressure at gas pipe rupture.

Note: IMO interpretation in 5.4.4 also applies to 5.13.2.4.

5.13.2.5 All piping systems, including valves, fittings and associated equipment for handling cargo or vapours, shall be tested under normal operating conditions not later than at the first loading operation, in accordance with recognized standards.

Note: IACS Interpretation in 4.20.3.5 also applies to this 5.13.2.5.

5.13.3 *Emergency shutdown valves*

The closing characteristics of emergency shutdown valves used in liquid cargo piping systems shall be tested to demonstrate compliance with 18.10.2.1.3. This testing may be carried out on board after installation.

5.14 **Liquefied gas cargo and process piping**

IACS UR G3

Note: Some requirements of this UR G3 are identical with the requirements of Chapter 5.

5.14.1 **General** (G3.1)

5.14.1.1 The present texts give general principles for approval and survey of the relevant items of liquefied gas tankers for classification purposes. They do not intend to cover full details of such approval and survey procedures which are to be found in the rules of each Classification Society. (G3.1.1)

5.14.1.2 Consideration of future technical advances may warrant modifications to the principles and details set forth in the text. IACS will accordingly review continuously these requirements. (G3.1.2)

5.14.1.3 IGC Code means the International Code for the Construction and Equipment of Ships Carrying Liquefied Gases in Bulk (as amended by IMO Resolutions MSC.370(93), MSC.411(97) and MSC.441(99)). (G3.1.3)

5.14.2 **Scope**

The requirements here below apply to liquefied gas cargo and process piping including cargo gas piping and exhaust lines of safety valves or similar piping. (G3.2)

5.14.3 **Scantlings for internal pressure** (G3.3)

5.14.3.1 **Piping Scantlings** (see also 5.11.1.1)

Piping systems are to be designed in accordance with recognized standards acceptable to the Classification Society. (G3.3.1)

5.14.3.2 Design pressure (see also 5.4)

- a) The design pressure P in the formula in 5.14.3.4 a) (G3.3.4 (a)) is the maximum pressure to which the system may be subjected in service.
- b) The greatest of the following design conditions is to be used for piping, piping systems and components, based on the cargoes being carried:
 - (i) for vapour piping systems or components which may be separated from their relief valves and which may contain some liquid, the saturated vapour pressure at 45°C, or higher or lower values, if agreed upon by the Classification Society, may be used (see 4.13.2.2 of these *Rules* (the IGC Code)).
 - (ii) for systems or components which may be separated from their relief valves and which contain only vapour at times, the superheated vapour pressure at 45°C or higher or lower values, if agreed upon by the Classification Society, may be used (see 4.13.2.2 of these *Rules* (the IGC Code)), assuming an initial condition of saturated vapour in the system operating pressure and temperature; or
 - (iii) design conditions defined in 5.4.2.3 to 5.4.2.5 of these *Rules* (the IGC Code).
- c) The minimum design pressure is not to be less than the value defined in 5.4.1 of these *Rules* (the IGC Code).
- d) The additional requirements regarding surge pressures defined in 5.4.3 of these *Rules* (the IGC Code) are to be complied with.
- e) The design pressure of the outer pipe or duct of gas fuel systems are not to be less than the value defined in 5.4.4 of these *Rules* (the IGC Code). (G3.3.2)

5.14.3.3 Allowable stress (see also 5.11.3)

For pipes, the allowable stress K referred to in the formula in 5.14.3.4 a) (G3.3.4 (a)) is the lower of the values defined in 5.11.3.1 of these *Rules* (the IGC Code). (G3.3.3)

5.14.3.4 Minimum wall thickness (see also 5.11.2)

- a) The wall thickness of pipes is not to be less than that determined from the following formula:

$$t = \frac{(t_0 + b + c)}{\left(1 - \frac{a}{100}\right)}$$

where:

- t = minimum thickness (mm)
- t_0 = theoretical thickness (mm)
- $t_0 = PD/(2Ke + P)$
- P = design pressure (MPa)
- D = outside diameter (mm)
- K = allowable stress (N/mm²) (see 5.14.3.3 (G3.3.3))
- e = efficiency factor

- (i) $e = 1$ for seamless pipes and for longitudinally or spirally welded pipes, delivered by manufactures approved for making welded pipes which are considered equivalent to seamless pipes when non destructive testing on welds is carried out in accordance with the Rules of the Classification Society.
 - (ii) in other cases an efficiency factor of less than 1.0 may be required by the Classification Society depending on the manufacturing process.
- b = allowance for bending (mm). The value of b is to be chosen so that the calculated stress in the bend, due to internal pressure only, does not exceed the allowable stress. Where such justification is not given, b is to be determined from the following formula:

$$b = \frac{1}{2,5} \frac{D}{r} t_0$$

with r = mean radius of the bend (mm)

c = corrosion allowance (mm). When corrosion or erosion is expected, an increase in wall thickness of the piping is to be provided over that required by other design requirements.

This allowance is to be consistent with the expected life of the piping.

a = negative manufacturing tolerance for thickness (%).

b) The minimum thickness is to be in accordance with recognized standards acceptable to the Classification Society.

c) The additional requirements in 5.11.2.4 of these *Rules* (the IGC Code) are to be complied with.

d) In fuel gas piping systems of design pressure greater than the critical pressure, the tangential membrane stress of straight section of pipe or ducting shall be according to 5.11.4 of these *Rules* (the IGC Code). (see also 5.11.4) (G3.3.4)

5.14.3.5 Flanges, valves, fittings etc. (see also 5.11.6)

a) For selection of flanges, valves, fittings etc., a recognised Standard is to be used taking into account the design pressure defined under 5.4 of these *Rules* (the IGC Code).

b) For flanges not complying with a recognised standard, the dimension of flanges and relative bolts are to be to the satisfaction of the Classification Society.

c) The design and installation of expansion bellows shall be in accordance with recognized standards acceptable to the Classification Society and to be fitted with means to prevent damage due to over-extension or compression. (G3.3.5)

5.14.4 Stress analysis (G3.4) (see also 5.11.5)

5.14.4.1 When design temperature is -110°C or lower, a complete stress analysis, taking into account all the stresses due to weight of pipes (including acceleration if significant), internal pressure, thermal contraction and loads induced by hog and sag of the ship for each branch of the piping system is to be submitted to the Classification Society. For temperatures above -110°C , stress analysis may be required in relation to design or stiffness of the piping system, choice of materials, etc; in any case, consideration is to be given by the designer to thermal stresses, even though calculations are not submitted. (G3.4.1)

5.14.4.2 This analysis is to take into account the various loads such as pressure, weight of piping with insulation and internal medium, loads due to the contraction, for the various operating conditions. The analysis may be carried out according to the Rules of the Classification Society or to a recognised code of practice. (G3.4.2)

5.14.5 Materials (G3.5) (see also 5.12)

5.14.5.1 Choice and testing of materials used in piping systems are to comply with 5.12.1 and 5.12.2 of these *Rules* (the IGC Code) and 6.4.2 (W1) taking into account the minimum design temperature. (G3.5.1)

5.14.5.2 For an outer pipe or duct equipped with mechanical exhaust ventilation having a capacity of at least 30 air changes per hour, the effects of both pressure and possible low temperature in the event of a high pressure line failure shall be taking into account (G3.5.2)

5.14.5.3 Where the cargo piping system is of a material susceptible to stress corrosion cracking in the presence of a salt-laden atmosphere, requirements of 5.12.4 of these *Rules* (the IGC Code) are to be complied with. (G3.5.3)

5.14.6 Tests of piping components and pumps prior to installation on board (G3.6)

5.14.6.1 Valves (G3.6.1) (see also 5.13.1.1)

5.14.6.1.1 Prototype Testing

Each type of valve intended to be used at a working temperature below -55°C shall be subject to the type tests defined in 5.13.1.1.1 to 5.13.1.1.3 of these *Rules* (the IGC Code).

For emergency shutdown valves, with materials having melting temperatures lower than 925°C, the type testing shall include a fire test to a standard acceptable to the Classification Society. (G3.6.1.1)

5.14.6.1.2 Unit Production Testing

All valves are to be tested at the plant of manufacturer in the presence of the Society's representative. Testing is to include hydrostatic test of the valve body at a pressure equal to 1.5 times the design pressure for all valves, seat and stem leakage test at a pressure equal to 1.1 times the design pressure for valves other than safety valves. In addition, cryogenic testing consisting of valve operation and leakage verification for a minimum of 10% of each type and size of valve for valves other than safety valves intended to be used at a working temperature below -55°C. The set pressure of safety valves is to be tested at ambient temperature.

For valves used for isolation of instrumentation in piping not greater than 25mm, unit production testing need not be witnessed by the surveyor. Records of testing are to be available for review.

As an alternative to the above, if so requested by the relevant Manufacturer, the certification of a valve may be issued subject to the following:

- The valve has been approved as required by 5.14.6.1.1 (3.6.1.1) for valves intended to be used at a working temperature below -55°C, and
- The manufacturer has a recognized quality system that has been assessed and certified by the Society subject to periodic audits, and
- The quality control plan contains a provision to subject each valve to a hydrostatic test of the valve body at a pressure equal to 1.5 times the design pressure for all valves and seat and stem leakage test at a pressure equal to 1.1 times the design pressure for valves other than safety valves. The set pressure of safety valves is to be tested at ambient temperature. The manufacturer is to maintain records of such tests, and
- Cryogenic testing consisting of valve operation and leakage verification for a minimum of 10% of each type and size of valve for valves other than safety valves intended to be used at a working temperature below -55°C in the presence of the Society's representative. (G3.6.1.2)

5.14.6.2 Bellows (see also 5.13.1.2)

The prototype tests defined in 5.13.1.2.1 to 5.13.1.2.4 of these *Rules* (the IGC Code) are to be performed on each type of expansion bellows intended for use on cargo piping outside the cargo tank and where required by the Administration or recognized organization acting on its behalf, on those installed within the cargo tanks. (G3.6.2)

5.14.6.3 Cargo Pumps and Gas/Reliquefaction/Refrigeration Compressors (G3.6.3)

Compressors and pumps are to be suitable for their intended purpose. All equipment and machinery are to be adequately designed to ensure suitability within a marine environment with due consideration to *Publication 11/P – Environmental Tests on Marine Equipment* (UR E10) and *PKiBSM Part VI, 1.16.2* (UR M46). Such items to be considered would include, but not be limited to:

- (a) environmental;
- (b) shipboard vibrations and accelerations;
- (c) effects of pitch, heave and roll motions, etc.; and
- (d) physical and chemical properties of product

The manufacturer is to submit documentation indicating the equipment has been designed to comply with the above criteria.

5.14.6.4 Cargo Pumps (G3.6.3.1)

Each size and type of pump is to be approved through design assessment and prototype testing. Prototype testing is to be witnessed in the presence of the Classification Society's representative.

For the design assessment of the pumps, ISO 13709:2009 and ISO 24490:2016, as applicable, can be used. Other applicable recognized standards acceptable to the Classification Society may be considered.

- (a) **Material Testing:** Tests for pump materials need not be witnessed by the Classification Society's representative except for the boundary components, which are in direct contact with the medium and for a design temperature below – 55°C in accordance with 6.2.2 of *these Rules* (the IGC Code).

Note: The following pump components can, for example, be considered boundary components:

- For centrifugal type pump: impeller, inducer, guide vane, casing, shaft and coupling.
- For reciprocating type pump: cylinder cover, valve cover, cylinder liner, piston and piston rod, crankshaft, crank case.

- (b) **Prototype Testing:** Prototype testing is to include hydrostatic test of the pump body equal to 1.5 times the design pressure and a capacity test. For submerged electric motor driven pumps, the capacity test is to be carried out with the design medium or with a medium below the minimum working temperature. For shaft driven deep well pumps, the capacity test may be carried out with water. In addition, for shaft driven deep well pumps, a spin test to demonstrate satisfactory operation of bearing clearances, wear rings and sealing arrangements is to be carried out at the minimum design temperature. The full length of shafting is not required for the spin test but must be of sufficient length to include at least one bearing and sealing arrangements. After completion of tests, the pump is to be opened out for examination.

The vibration criteria of machinery and equipment are to be provided by the pump manufacturer. These are to be compared against an applicable internationally recognised standard¹, as applied to the design, and are to be accepted by the Classification Society.

¹ The following standards can be used as guidance:

- ISO 7919-3:2009/AMD 1:2017, Mechanical vibration – Evaluation of machine vibration by measurements on rotating shafts – Part 3 Coupled industrial machines
- ISO 10816-3:2009/AMD 1: 2017, Evaluation of machine vibration by measurements on non-rotating parts – Part 3: Industrial machines with nominal power above 15 kW and nominal speeds between 120 r/min and 15 000 r/min when measured in situ.

- ISO 10816-7:2009, Mechanical vibration – Evaluation of machine vibration by measurements on non-rotating parts – Part 7: Rotodynamic pumps for industrial applications, including measurements on rotating shafts
- ISO 10816-8:2014, Mechanical vibration – Evaluation of machine vibration by measurements on non-rotating parts – Part 8: Reciprocating compressor systems
- ISO 20816-1:2016, Mechanical vibration – Measurement and evaluation of machine vibration – Part 1: General Guidelines
- ISO 20816-8:2018, Mechanical vibration - Measurement and evaluation of machine vibration – Part 8: Reciprocating compressor systems.

(c) Unit Production Testing

All pumps are to be tested at the plant of manufacturer in the presence of the Classification Society's representative. Testing is to include hydrostatic test of the pump body equal to 1.5 times the design pressure and a capacity test. For submerged electric motor driven pumps, the capacity test is to be carried out with the design medium or with a medium below the minimum working temperature. For shaft driven deep well pumps, the capacity test may be carried out with water.

As an alternative to the above, if so, requested by the relevant Manufacturer, the certification of a pump may be issued subject to the following:

- The pump has been approved as required by 5.14.6.4 (3.6.3.1) (a) and (b), and
- The manufacturer has a recognised quality system that has been assessed and certified by the Classification Society subject to periodic audits, and
- The quality control plan contains a provision to subject each pump to a hydrostatic test of the pump body equal to 1.5 times the design pressure and a capacity test. The manufacturer is to maintain records of such tests.

5.14.6.5 Gas Cargo and Reliquefaction/Refrigeration Compressors (G3.6.3.2)

Each size and type of compressor is to be approved through design assessment and prototype testing. Prototype testing is to be witnessed in the presence of the Classification Society's representative.

For the design assessment of the gas compressors, API standards. 617:2014 (w. Errata 1:2016), 618:2016 or 619:2010, as applicable, can be used. Other applicable recognized standards acceptable to the Classification Society may be considered.

(a) Material Testing: Tests for compressor materials need not be witnessed by the Classification Society's representative except for the boundary components, which are in direct contact with the medium and for a design temperature below – 55°C in accordance with 6.2.2 of *these Rules* (the IGC Code).

Note: The following compressor components can, for example, be considered boundary components:

- For centrifugal type compressor: impeller, inducer, guide vane, casing, shaft and coupling.
- For reciprocating type compressor: cylinder cover, valve cover, cylinder liner, piston and piston rod, crankshaft, crank case.

(b) Prototype Testing: Prototype testing is to be consistent with the applicable standard as applied for design assessment and is to include hydrostatic test of the compressor pressure boundary components, mechanical running test and a performance test. The hydrostatic test is to be carried out at a pressure equal to 1.5 times the design pressure (or 1.25 times the design pressure where the test fluid is compressible) and for, at least, 30 minutes. The mechanical running test and performance tests should include recording of the gas used, temperatures, pressures, testing of alarms and shut down, pressure relief devices and vibration measurements to ensure that the limits do not exceed those proposed by the

manufacturer and that other features relating to the performance of the equipment are in accordance with the specification. Similarly, during the performance test, power consumption and the gas loads are to be recorded.

The vibration criteria of machinery and equipment are to be provided by manufacturers, consistent with the applicable recognized standard¹ as applied to the design. Otherwise, when the data on the vibration criteria are not available, justification is to be submitted for criteria used as reference in terms of overall Root Mean Square (RMS) vibrational velocity value for normal operation conditions.

¹ The following standards can be used as guidance:

- ISO 7919-3:2009/AMD 1:2017, Mechanical vibration – Evaluation of machine vibration by measurements on rotating shafts – Part 3 Coupled industrial machines
- ISO 10816-3:2009/AMD 1: 2017, Evaluation of machine vibration by measurements on non-rotating parts – Part 3: Industrial machines with nominal power above 15 kW and nominal speeds between 120 r/min and 15 000 r/min when measured in situ.
- ISO 10816-7:2009, Mechanical vibration – Evaluation of machine vibration by measurements on non-rotating parts – Part 7: Rotodynamic pumps for industrial applications, including measurements on rotating shafts
- ISO 10816-8:2014, Mechanical vibration – Evaluation of machine vibration by measurements on non-rotating parts – Part 8: Reciprocating compressor systems
- ISO 20816-1:2016, Mechanical vibration – Measurement and evaluation of machine vibration – Part 1: General Guidelines
- ISO 20816-8:2018, Mechanical vibration - Measurement and evaluation of machine vibration – Part 8: Reciprocating compressor systems.

Alternative limits, demonstrated by fatigue calculations, may be accepted by the Classification Society.

- (c) Unit Production Testing: Each compressor is to be tested at the plant of manufacture in the presence of the Classification Society's representative. Testing is to include hydrostatic test of the compressor pressure boundary components. The hydrostatic test is to be carried out at a pressure equal to 1.5 times the design pressure (or 1.25 times the design pressure where the test fluid is compressible) and for, at least, 30 minutes.

As an alternative to the above, if so, requested by the relevant Manufacturer, the certification of a compressor may be issued subject to the following:

- The compressor has been approved as required by 5.14.6.5 (3.6.3.2) (a) and (b), and
- The manufacturer has a recognised quality system that has been assessed and certified by the Classification Society subject to periodic audits, and
- The quality control plan contains a provision to subject each compressor to the hydrostatic test of the compressor body equal to 1.5 times the design pressure (or 1.25 times the design pressure where the test fluid is compressible) for, at least, 30 minutes, and a mechanical running and performance test. The manufacturer is to maintain records of such tests.

- (d) Installation: The complete compressor assembly connected to the vessel systems is to be subjected to a leak test using air or other suitable medium, to a pressure depending on the leak detection method applied. The test is to be performed in presence of the Classification Society's representative and considered satisfactory when no joint leaks are observed.

5.14.7 Piping fabrication and joining details (G3.7)

5.14.7.1 General (see also 5.8.1)

The requirements of this section apply to piping inside and outside the cargo tanks. However, the Classification Society may accept relaxations from these requirements for piping inside cargo tanks and open ended piping. (G3.7.1)

5.14.7.2 Direct connection of pipe lengths (without flanges) (see also 5.8.2)

The types of connections defined in 5.8.2.1 to 5.8.2.3 of these *Rules* (the IGC Code) may be considered. (G3.7.2)

5.14.7.3 Flange connections (see also 5.8.3)

- a) Flanges are to be of the welding neck, slip-on or socket welding type.
- b) Flanges are to be selected as to type, made and tested in accordance with the Rules of the Classification Society. For all piping (except open end lines) the restrictions defined in 5.8.3.2.1 and 5.8.3.2.2 of these *Rules* (the IGC Code) apply. (G3.7.3)

5.14.7.4 Other types of pipes connections (see also 5.8.5)

Acceptance of types of piping connections other than those mentioned in 5.14.7.2 (G3.7.2) and 5.14.7.3 (G3.7.3) may be considered by the Classification Society in each particular case. (G3.7.4)

5.14.7.5 Bellows and expansion joints (see also 5.8.4)

Where bellows and expansion joints are provided, requirements in 5.8.4 of these *Rules* (the IGC Code) are to be complied with. (G3.7.5)

5.14.7.6 Welding, post-weld heat treatments and non-destructive tests (see also 5.9)

- a) Welding is to be carried out in accordance with 5.9 of these *Rules* (the IGC Code and requirements of the Classification Society).
- b) Post-weld heat treatments are required for all butt welds of pipes made with carbon, carbon-manganese and low alloy steels.

The Classification Society may waive the requirement for thermal stress relieving for pipes having a wall thickness less than 10 mm in relation to the design temperature and pressure of the concerned piping system.

- c) In addition to normal procedures before and during the welding and also visual inspection of the finished welds, as necessary for proving that the manufacture has been carried out in a correct way according to the requirements, the following inspections are required:
 - (i) 100% radiographic or ultrasonic inspection testing of butt welded joints for piping systems with service temperatures lower than -10°C, and with inside diameters of more than 75 mm or wall thickness greater than 10 mm.
 - (ii) For butt welded joints of pipes not included in (i), spot radiographic controls or other non-destructive controls are to be carried out at the discretion of the Classification Society depending upon service, position and materials. In general at least 10% of butt welded joints of pipe are to be subjected to radiographic or ultrasonic inspection. (G3.7.6)

5.14.8 Tests onboard (G3.8) (see also 5.13.2)

5.14.8.1 General

The requirements of this section apply to piping inside and outside the cargo tanks. (G3.8.1)

5.14.8.2 Pressure tests (strength and leak test)

- a) After assembly, all cargo and process piping should be subjected to a strength test with a suitable fluid in accordance with 5.13.2.2 of these *Rules* (the IGC Code).
- b) The additional requirements regarding leak tests defined in 5.13.2.3 of these *Rules* (the IGC Code) are to be complied with.
- c) The additional requirements regarding double wall gas-fuel piping system defined in 5.13.2.4 of these *Rules* (the IGC Code) are to be complied with. (G3.8.2)

5.14.8.3 Functional tests

All piping systems including all valves, fittings and associated equipment for handling cargo or vapours are to be tested under normal operating conditions not later than at the first loading operation, in accordance with recognized standards acceptable to the Classification Society. (G3.8.3)

5.14.9 Cargo piping insulation system (G3.9) (see also 5.12.3)

5.14.9.1 Requirements regarding cargo piping insulation in 5.12.3.1 and 5.12.3.2 of these *Rules* (the IGC Code) are to be complied with. (G3.9.1)

END OF IACS UR G3

CHAPTER 6

(IGC Code Chapter 6)

Goal

To identify the required properties, testing standards and stability of metallic and non-metallic materials and fabrication processes used in the construction of cargo containment and piping systems to ensure they serve the functions for which they have been selected, as required in Chapters 4 and 5.

6 MATERIALS OF CONSTRUCTION AND QUALITY CONTROL**6.1 Definitions**

6.1.1 Where reference is made in this Chapter to A, B, D, E, AH, DH, EH and FH hull structural steels, these steel grades are hull structural steels according to recognized standards.

6.1.2 A *piece* is the rolled product from a single slab or billet or from a single ingot, if this is rolled directly into plates, strips, sections or bars.

6.1.3 A *batch* is the number of items or pieces to be accepted or rejected together, on the basis of the tests to be carried out on a sampling basis. The size of a batch is given in the recognized standards.

6.1.4 *Controlled rolling (CR)* is a rolling procedure in which the final deformation is carried out in the normalizing temperature range, resulting in a material condition generally equivalent to that obtained by normalizing.

6.1.5 *Thermo-mechanical controlled processing (TMCP)* is a procedure that involves strict control of both the steel temperature and the rolling reduction. Unlike CR, the properties conferred by TMCP cannot be reproduced by subsequent normalizing or other heat treatment. The use of accelerated cooling on completion of TMCP may also be accepted, subject to approval by the Administration. The same applies for the use of tempering after completion of TMCP.

6.1.6 *Accelerated cooling (AcC)* is a process that aims to improve mechanical properties by controlled cooling with rates higher than air cooling, immediately after the final TMCP operation. Direct quenching is excluded from accelerated cooling. The material properties conferred by TMCP and AcC cannot be reproduced by subsequent normalizing or other heat treatment.

6.2 Scope and general requirements

6.2.1 This Chapter gives the requirements for metallic and non-metallic materials used in the construction of the cargo system. This includes requirements for joining processes, production process, personnel qualification, NDT and inspection and testing including production testing. The requirements for rolled materials, forgings and castings are given in 6.4 and tables 6.1, to 6.5. The requirements for weldments are given in 6.5, and the guidance for non-metallic materials is given in Appendix 4. A quality assurance/quality control programme shall be implemented to ensure that the requirements of 6.2 are complied with.

6.2.2 The manufacture, testing, inspection and documentation shall be in accordance with recognized standards and the specific requirements given in these *Rules* (the Code).

6.2.3 Where post-weld heat treatment is specified or required, the properties of the base material shall be determined in the heat-treated condition, in accordance with the applicable table of this Chapter, and the weld properties shall be determined in the heat treated condition in accordance with 6.5. In cases where a post-weld heat treatment is applied, the test requirements may be modified at the discretion of the Administration.

6.3 General test requirements and specifications

6.3.1 Tensile test

6.3.1.1 Tensile testing shall be carried out in accordance with recognized standards.

6.3.1.2 Tensile strength, yield stress and elongation shall be to the satisfaction of the Administration. For carbon-manganese steel and other materials with definitive yield points, consideration shall be given to the limitation of the yield to tensile ratio.

6.3.2 Toughness test

6.3.2.1 Acceptance tests for metallic materials shall include Charpy V-notch toughness tests, unless otherwise specified by the Administration. The specified Charpy V-notch requirements are minimum average energy values for three full size (10 mm × 10 mm) specimens and minimum single energy values for individual specimens. Dimensions and tolerances of Charpy V-notch specimens shall be in accordance with recognized standards. The testing and requirements for specimens smaller than 5 mm in size shall be in accordance with recognized standards. Minimum average values for subsized specimens shall be:

Charpy V-notch specimen size (mm)	Minimum average energy of three specimens
10 x 10	KV
10 x 7.5	5/6 KV
10 x 5	2/3 KV

where:

KV = the energy values (J) specified in tables 6.1 to 6.4.

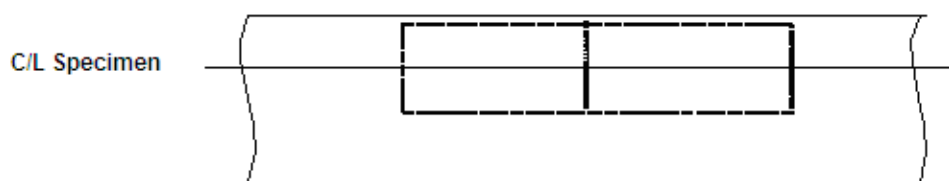

Figure 6.1 – Orientation of base metal test specimen

6.3.2.2 For a weld test specimen, the largest size Charpy V-notch specimens possible for the material thickness shall be machined, with the specimens located as near as practicable to a point midway between the surface and the centre of the thickness. In all cases, the distance from the surface of the material to the edge of the specimen shall be approximately 1 mm or greater. In addition, for double-V butt welds, specimens shall be machined closer to the surface of the second welded section. The specimens shall be taken generally at each of the following locations, as shown in figure 6.2, on the centreline of the welds, the fusion line and 1 mm, 3 mm and 5 mm from the fusion line.

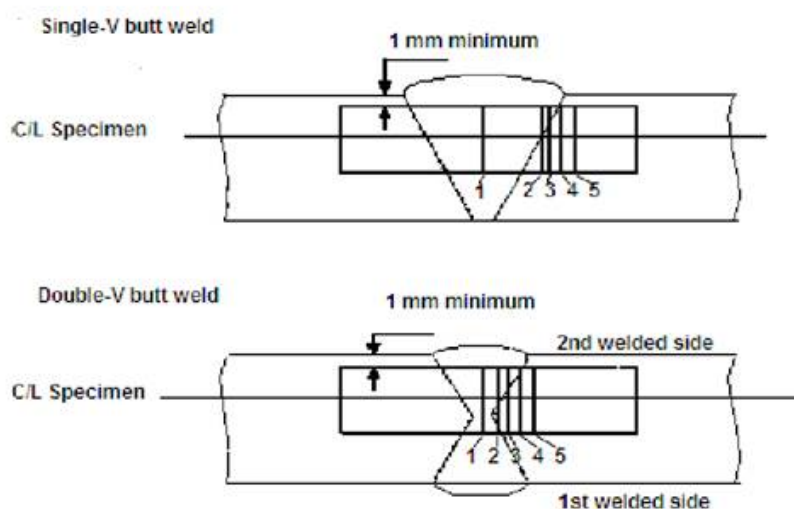

Figure 6.2 – Orientation of weld test specimen

Notch locations in figure 6.2:

- 1 Centreline of the weld.
- 2 Fusion line.
- 3 In heat-affected zone (HAZ), 1 mm from the fusion line.
- 4 In HAZ, 3 mm from the fusion line.
- 5 In HAZ, 5 mm from the fusion line.

6.3.2.3 If the average value of the three initial Charpy V-notch specimens fails to meet the stated requirements, or the value for more than one specimen is below the required average value, or when the value for one specimen is below the minimum value permitted for a single specimen, three additional specimens from the same material may be tested and the results be combined with those previously obtained to form a new average. If this new average complies with the requirements and if no more than two individual results are lower than the required average and no more than one result is lower than the required value for a single specimen, the piece or batch may be accepted.

6.3.3 Bend test

6.3.3.1 The bend test may be omitted as a material acceptance test, but is required for weld tests. Where a bend test is performed, this shall be done in accordance with recognized standards.

6.3.3.2 The bend tests shall be transverse bend tests, which may be face, root or side bends at the discretion of the Administration. However, longitudinal bend tests may be required in lieu of transverse bend tests in cases where the base material and weld metal have different strength levels.

6.3.4 Section observation and other testing

Macrosection, microsection observations and hardness tests may also be required by the Administration, and they shall be carried out in accordance with recognized standards, where required.

6.4 Requirements for metallic materials

6.4.1 General requirements for metallic materials

6.4.1.1 The requirements for materials of construction are shown in the tables as follows:

- .1 **Table 6.1:** Plates, pipes (seamless and welded), sections and forgings for cargo tanks and process pressure vessels for design temperatures not lower than 0°C.

Note: See additional requirements to Table 6.1 in 6.4.2.

- .2 **Table 6.2:** Plates, sections and forgings for cargo tanks, secondary barriers and process pressure vessels for design temperatures below 0°C and down to -55°C.

Note: See additional requirements to Table 6.2 in 6.4.2.

- .3 **Table 6.3:** Plates, sections and forgings for cargo tanks, secondary barriers and process pressure vessels for design temperatures below -55°C and down to -165°C.

Note: See additional requirements to Table 6.3 in 6.4.2.

- .4 **Table 6.4:** Pipes (seamless and welded), forgings and castings for cargo and process piping for design temperatures below 0°C and down to -165°C.

- .5 **Table 6.5:** Plates and sections for hull structures required by 4.19.1.2 and 4.19.1.3.

Table 6.1

PLATES, PIPES (SEAMLESS AND WELDED) ^{See notes 1 and 2} , SECTIONS AND FORGINGS FOR CARGO TANKS AND PROCESS PRESSURE VESSELS FOR DESIGN TEMPERATURES NOT LOWER THAN 0°C		
CHEMICAL COMPOSITION AND HEAT TREATMENT		
Carbon-manganese steel		
Fully killed fine grain steel		
Small additions of alloying elements by agreement with the Administration		
Composition limits to be approved by the Administration		
Normalized, or quenched and tempered ^{See note 4}		
TENSILE AND TOUGHNESS (IMPACT) TEST REQUIREMENTS		
Sampling frequency		
Plates	Each "piece" to be tested	
Sections and forgings	Each "batch" to be tested.	
Mechanical properties		
Tensile properties	Specified minimum yield stress not to exceed 410 N/mm ² ^{See note 5}	
Toughness (Charpy V-notch test)		
Plates	Transverse test pieces. Minimum average energy value (KV) 27J	
Sections and forgings	Longitudinal test pieces. Minimum average energy (KV) 41J	
Test temperature	Thickness <i>t</i> (mm)	Test temperature (°C)
	$t \leq 20$	0
	$20 < t \leq 40$ ^{See note 3}	-20
Notes		
1 For seamless pipes and fittings normal practice applies. The use of longitudinally and spirally welded pipes shall be specially approved by the Administration or recognized organization acting on its behalf.		
2 Charpy V-notch impact tests are not required for pipes.		
3 This table is generally applicable for material thicknesses up to 40 mm. Proposals for greater thicknesses shall be approved by the Administration or recognized organization acting on its behalf.		

- 4 A controlled rolling procedure or TMCP may be used as an alternative.
 5 Materials with specified minimum yield stress exceeding 410 N/mm² may be approved by the Administration or recognized organization acting on its behalf. For these materials, particular attention shall be given to the hardness of the welded and heat affected zones.

Table 6.2

PLATES, SECTIONS AND FORGINGS <small>See note 1</small> FOR CARGO TANKS, SECONDARY BARRIERS AND PROCESS PRESSURE VESSELS FOR DESIGN TEMPERATURES BELOW 0°C AND DOWN TO -55°C Maximum thickness 25 mm <small>See note 2</small>					
CHEMICAL COMPOSITION AND HEAT TREATMENT					
Carbon-manganese steel					
Fully killed, aluminium treated fine grain steel					
Chemical composition (ladle analysis)					
C	Mn	Si	S	P	
0.16% max <small>See note 3</small>	0.7-1.60%	0.1-0.50%	0.025% max	0.025% max	
Optional additions: Alloys and grain refining elements may be generally in accordance with the following:					
Ni	Cr	Mo	Cu	Nb	V
0.8% max	0.25% max	0.08% max	0.35% max	0.05% max	0.1% max
Al content total 0.02% min (Acid soluble 0.015% min)					
Normalized, or quenched and tempered <small>See note 4</small>					
TENSILE AND TOUGHNESS (IMPACT) TEST REQUIREMENTS					
Sampling frequency					
Plates		Each "piece" to be tested			
Sections and forgings		Each "batch" to be tested			
Mechanical properties					
Tensile properties		Specified minimum yield stress not to exceed 410 N/mm ² <small>See note 5</small>			
Toughness (Charpy V-notch test)					
Plates		Transverse test pieces. Minimum average energy value (KV) 27J			
Sections and forgings		Longitudinal test pieces. Minimum average energy (KV) 41J			
Test temperature		5°C below the design temperature or -20°C, whichever is lower			
Notes					
1 The Charpy V-notch and chemistry requirements for forgings may be specially considered by the Administration.					
2 For material thickness of more than 25 mm, Charpy V-notch tests shall be conducted as follows:					
Material thickness (mm)		Test temperature (°C)			
20 < t ≤ 30		10°C below the design temperature or -20°C, whichever is lower			
30 < t ≤ 35		15°C below the design temperature or -20°C, whichever is lower			
35 < t ≤ 40		20°C below the design temperature			
40 < t		Temperature approved by the Administration or recognized organization acting on its behalf			
The impact energy value shall be in accordance with the table for the applicable type of test specimen.					
Materials for tanks and parts of tanks which are completely thermally stress relieved after welding may be tested at a temperature 5°C below design temperature or -20°C, whichever is lower.					
For thermally stress relieved reinforcements and other fittings, the test temperature shall be the same as that required for the adjacent tank-shell thickness.					

- 3 By special agreement with the Administration, the carbon content may be increased to 0.18% maximum, provided the design temperature is not lower than -40°C.
- 4 A controlled rolling procedure or TMCP may be used as an alternative.
- 5 Materials with specified minimum yield stress exceeding 410 N/mm² may be approved by the Administration or recognized organization acting on its behalf. For these materials, particular attention shall be given to the hardness of the welded and heat affected zones.

Guidance:

For materials exceeding 25 mm in thickness for which the test temperature is -60°C or lower, the application of specially treated steels or steels in accordance with table 6.3 may be necessary.

Table 6.3

PLATES, SECTIONS AND FORGINGS See note 1 FOR CARGO TANKS, SECONDARY BARRIERS AND PROCESS PRESSURE VESSELS FOR DESIGN TEMPERATURES BELOW -55°C AND DOWN TO -165°C See note 2		
Maximum thickness 25 mm See notes 3 and 4		
Minimum design temperature (°C)	Chemical composition See note 5 and heat treatment	Impact test temperature (°C)
-60	1.5% nickel steel – normalized or normalized and tempered or quenched and tempered or TMCP See note 6	-65
-65	2.25% nickel steel – normalized or normalized and tempered or quenched and tempered or TMCP See notes 6 and 7	-70
-90	3.5% nickel steel – normalized or normalized and tempered or quenched and tempered or TMCP See notes 6 and 7	-95
-105	5% nickel steel – normalized or normalized and tempered or quenched and tempered See notes 6, 7 and 8	-110
-165	9% nickel steel – double normalized and tempered or quenched and tempered See note 6	-196
-165	Austenitic steels, such as types 304, 304L, 316, 316L, 321 and 347 solution treated See note 9	-196
-165	High manganese austenitic steel – hot rolling and controlled cooling See notes 10 and 11	-196
-165	Aluminium alloys; such as type 5083 annealed	Not required
-165	Austenitic Fe-Ni alloy (36% nickel). Heat treatment as agreed	Not required
TENSILE AND TOUGHNESS (IMPACT) TEST REQUIREMENTS		
Sampling frequency		
Plates	Each "piece" to be tested	
Sections and forgings	Each "batch" to be tested	
Toughness (Charpy V-notch test)		
Plates	Transverse test pieces. Minimum average energy value (KV) 27J	
Sections and forgings	Longitudinal test pieces. Minimum average energy (KV) 41J	
Notes		
1 The impact test required for forgings used in critical applications shall be subject to special consideration by the Administration.		
2 The requirements for design temperatures below -165°C shall be specially agreed with the Administration.		
3 For materials 1.5% Ni, 2.25% Ni, 3.5% Ni and 5% Ni, with thicknesses greater than 25 mm, the impact tests shall be conducted as follows:		
Material thickness (mm)	Test temperature (°C)	
25 < t ≤ 30	10°C below the design temperature or -20°C, whichever is lower	
30 < t ≤ 35	15°C below the design temperature or -20°C, whichever is lower	

$35 < t \leq 40$	20°C below the design temperature
<p>The energy value shall be in accordance with the table for the applicable type of test specimen. For material thickness of more than 40 mm, the Charpy V-notch values shall be specially considered.</p>	
<p>4 For 9% Ni steels, austenitic stainless steels and aluminium alloys, thickness greater than 25 mm may be used.</p>	
<p>5 The chemical composition limits shall be in accordance with recognized standards.</p>	
<p>6 TMCP nickel steels will be subject to acceptance by the Administration.</p>	
<p>7 A lower minimum design temperature for quenched and tempered steels may be specially agreed with the Administration.</p>	
<p>8 A specially heat treated 5% nickel steel, for example triple heat treated 5% nickel steel, may be used down to -165°C, provided that the impact tests are carried out at -196°C.</p>	
<p>9 The impact test may be omitted, subject to agreement with the Administration.</p>	
<p>10 The use of the material shall be subject to the required conditions specified by the Administration based on the Guidelines developed by the Organization. *</p>	
<p>* Refer to the Revised guidelines on the application of high manganese austenitic steel for cryogenic service (MSC.1/Circ.1599/Rev.2).</p>	
<p>11 The impact test may not be omitted for high manganese austenitic steel.</p>	

Table 6.4

PIPES (SEAMLESS AND WELDED) See note 1, FORGINGS See note 2 AND CASTINGS See note 2 FOR CARGO AND PROCESS PIPING FOR DESIGN TEMPERATURES BELOW 0°C AND DOWN TO -165°C See note 3 Maximum thickness 25 mm			
Minimum design temperature (°C)	Chemical composition See note 5 and heat treatment	Impact test	
		Test temp. (°C)	Minimum average energy (KV)
-55	Carbon-manganese steel. Fully killed fine grain. Normalized or as agreed See note 6	See note 4	27
-65	2.25% nickel steel. Normalized, normalized and tempered or quenched and tempered See note 6	-70	34
-90	3.5% nickel steel. Normalized, normalized and tempered or quenched and tempered See note 6	-95	34
-165	9% nickel steel See note 7. Double normalized and tempered or quenched and tempered	-196	41
	Austenitic steels, such as types 304, 304L, 316, 316L, 321 and 347. Solution treated See note 8	-196	41
	Aluminium alloys; such as type 5083 annealed		Not required
TENSILE AND TOUGHNESS (IMPACT) TEST REQUIREMENTS			
Sampling frequency			
Each "batch" to be tested.			
Toughness (Charpy V-notch test)			
Impact test: Longitudinal test pieces			
Notes			
1 The use of longitudinally or spirally welded pipes shall be specially approved by the Administration.			
2 The requirements for forgings and castings may be subject to special consideration by the Administration.			
3 The requirements for design temperatures below -165°C shall be specially agreed with the Administration.			
4 The test temperature shall be 5°C below the design temperature or -20°C, whichever is lower.			
5 The composition limits shall be in accordance with recognized standards.			
6 A lower design temperature may be specially agreed with the Administration for quenched and tempered materials.			
7 This chemical composition is not suitable for castings.			
8 Impact tests may be omitted, subject to agreement with the Administration.			

Table 6.5

PLATES AND SECTIONS FOR HULL STRUCTURES REQUIRED BY 4.19.1.2 AND 4.19.1.3								
Minimum design temperature of hull structure (°C)	Maximum thickness (mm) for steel grades							
	A	B	D	E	AH	DH	EH	FH
0 and above <small>See note 1</small> -5 and above <small>See note 2</small>	Recognized standards							
down to -5	15	25	30	50	25	45	50	50
down to -10	x	20	25	50	20	40	50	50
down to -20	x	x	20	50	x	30	50	50
down to -30	x	x	x	40	x	20	40	50
Below -30	In accordance with table 6.2, except that the thickness limitation given in table 6.2 and in note 2 of that table does not apply.							
Notes "x" means steel grade not to be used. 1 For the purpose of 4.19.1.3. 2 For the purpose of 4.19.1.2.								

6.4.2 Material and welding for ships carrying liquefied gases in bulk and ships using gases or other low-flashpoint fuels

IACS UR W1

6.4.2.1 Scope (1)

6.4.2.1.1 This document gives additional requirements to the ones prescribed in these *Rules* (the *International Code for the Construction and Equipment of Ships Carrying Liquefied Gases in Bulk* (IGC Code) or *International Code of Safety for Ships using Gases or other low-flashpoint Fuels* (IGF Code)). (1.1)

6.4.2.1.2 The manufacture, testing, inspection and documentation shall be in accordance with the general practice of the Classification Society. (1.2)

6.4.2.2 Material requirements

In addition to these *Rules* Table 6.1 (IGC Code Table 6.1 or IGF Code Table 7.1) for design temperature not lower than 0°C, the following applies. (2)

Table 1 Plates, pipes (seamless and welded), sections and forgings for cargo tanks, fuel tanks and process pressure vessels for design temperatures not lower than 0°C.

CHARPY V-NOTCH IMPACT TEST REQUIREMENTS		
TEST TEMPERATURE	Thickness t (mm)	Test temperature (°C)
	40 < t ≤ 50 ⁽¹⁾	-20 ⁽²⁾
	40 < t ≤ 50 ⁽¹⁾	-30 ⁽³⁾
NOTES:		
(1) A further set of impact test at mid thickness for products with t>40mm is required except rolled steels specified in <i>PKiBSM, Part IX</i> , chapter 3 or 4 (UR W11 or W16).		
(2) Applies to type C independent tanks and process pressure vessels. In addition, post-weld stress relief heat treatment shall be performed. Exemption to post-weld stress relief heat treatment based on alternative approach (e.g. Engineering Critical Assessment) shall be approved by the Classification Society or shall be to recognized standards.		
(3) Applies to cargo tank or fuel tank other than type C.		

In addition to these *Rules* Table 6.2 (IGC Code Table 6.2 or IGF Code Table 7.2), the following applies:

Table 2a Plates, sections and forgings for cargo tanks, fuel tanks, secondary barriers and process pressure vessels for design temperatures below 0°C and strictly down to -10°C

CHARPY V-NOTCH IMPACT TEST REQUIREMENTS		
TEST TEMPERATURE	Thickness t (mm)	Test temperature (°C)
	40 < t ≤ 50 ⁽¹⁾	5 °C below design temperature or -20°C, whichever is lower ⁽²⁾
	40 < t ≤ 45 ⁽¹⁾	25 °C below design temperature ⁽³⁾
	45 < t ≤ 50 ⁽¹⁾	30 °C below design temperature ⁽³⁾
NOTES:		
(1) A further set of impact test at mid thickness for products with t>40mm is required except rolled steels specified in <i>PKiBSM, Part IX, chapter 3 or 4</i> (UR W11 or W16).		
(2) Applies to type C independent tanks and process pressure vessels. In addition, post-weld stress relief heat treatment shall be performed. Exemption to post-weld stress relief heat treatment based on alternative approach (e.g. Engineering Critical Assessment) shall be approved by the Classification Society or shall be to recognized standards.		
(3) Applies to cargo tank or fuel tank other than type C.		

Table 2b Plates, sections and forgings for cargo tanks, fuel tanks, secondary barriers and process pressure vessels for design temperatures below -10°C and down to -55°C

CHARPY V-NOTCH IMPACT TEST REQUIREMENTS		
TEST TEMPERATURE	Thickness t (mm)	Test temperature (°C)
	40 < t ≤ 50 ⁽¹⁾	5 °C below design temperature or -20°C, whichever is lower ⁽²⁾
	40 < t ≤ 45 ⁽¹⁾	25 °C below design temperature ⁽³⁾
	45 < t ≤ 50 ⁽¹⁾	30 °C below design temperature ⁽³⁾
NOTES:		
(1) A further set of impact test at mid thickness for products with t>40mm is required except rolled steels specified in <i>PKiBSM, Part IX, chapter 3 or 4</i> (UR W11 or W16).		
(2) 6.6.2.2 (IGC code section 6.6.2.2) applies with regards to post-weld stress relief heat treatment. Exemption to post-weld stress relief heat treatment based on alternative approach (e.g. Engineering Critical Assessment) shall be approved by the Classification Society or shall be to recognized standards..		
(3) Applies to cargo tank or fuel tank other than type C.		

In addition to these *Rules* Table 6.3 (IGC Code Table 6.3 or IGF Code Table 7.3), the following applies:

Table 3 Plates, sections and forgings for cargo tanks, fuel tanks, secondary barriers and process pressure vessels for design temperatures below -55°C and down to -165°C.

CHARPY V-NOTCH IMPACT TEST REQUIREMENTS	
40 < t ≤ 45 ⁽¹⁾	25 °C below design temperature
45 < t ≤ 50 ⁽¹⁾	30 °C below design temperature
(1) A further set of impact test at mid thickness for products with t>40mm is required except rolled steels specified in <i>PKiBSM, Part IX, chapter 3 or 4</i> (UR W11 or W16).	

END OF IACS UR W1

6.5 Welding of metallic materials and non-destructive testing

6.5.1 General

6.5.1.1 This section shall apply to primary and secondary barriers only, including the inner hull where this forms the secondary barrier. Acceptance testing is specified for carbon, carbon-manganese, nickel alloy and stainless steels, but these tests may be adapted for other materials. At the discretion of the Administration, impact testing of stainless steel and aluminium alloy weldments may be omitted and other tests may be specially required for any material.

6.5.2 Welding consumables

6.5.2.1 Consumables intended for welding of cargo tanks shall be in accordance with recognized standards. Deposited weld metal tests and butt weld tests shall be required for all consumables. The results obtained from tensile and Charpy V-notch impact tests shall be in accordance with recognized standards. The chemical composition of the deposited weld metal shall be recorded for information.

6.5.3 Welding procedure tests for cargo tanks and process pressure vessels

6.5.3.1 Welding procedure tests for cargo tanks and process pressure vessels are required for all butt welds.

6.5.3.2 The test assemblies shall be representative of:

- .1 each base material;
- .2 each type of consumable and welding process; and
- .3 each welding position.

6.5.3.3 For butt welds in plates, the test assemblies shall be so prepared that the rolling direction is parallel to the direction of welding. The range of thickness qualified by each welding procedure test shall be in accordance with recognized standards. Radiographic or ultrasonic testing may be performed at the option of the fabricator.

6.5.3.4 The following welding procedure tests for cargo tanks and process pressure vessels shall be carried out in accordance with 6.3, with specimens made from each test assembly:

- .1 cross-weld tensile tests;
- .2 longitudinal all-weld testing, where required by the recognized standards;
- .3 transverse bend tests, which may be face, root or side bends. However, longitudinal bend tests may be required in lieu of transverse bend tests in cases where the base material and weld metal have different strength levels;
- .4 one set of three Charpy V-notch impacts, generally at each of the following locations, as shown in figure 6.2:
 - .1 centreline of the weld;
 - .2 fusion line;
 - .3 1 mm from the fusion line;
 - .4 3 mm from the fusion line; and
 - .5 5 mm from the fusion line; and
- .5 macrosection, microsection and hardness survey may also be required.

6.5.3.5 Each test shall satisfy the following requirements:

- .1 tensile tests: cross-weld tensile strength shall not be less than the specified minimum tensile strength for the appropriate parent materials. For materials such as aluminium alloys, reference shall be made to 4.18.1.3 with regard to the requirements for weld metal

strength of under-matched welds (where the weld metal has a lower tensile strength than the parent metal). In every case, the position of fracture shall be recorded for information;

- .2 bend tests: no fracture is acceptable after a 180° bend over a former of a diameter four times the thickness of the test pieces; and
- .3 Charpy V-notch impact tests: Charpy V-notch tests shall be conducted at the temperature prescribed for the base material being joined. The results of weld metal impact tests, minimum average energy (KV), shall be no less than 27 J. The weld metal requirements for subsize specimens and single energy values shall be in accordance with 6.3.2. The results of fusion line and heat-affected zone impact tests shall show a minimum average energy (KV) in accordance with the transverse or longitudinal requirements of the base material, whichever is applicable, and for subsize specimens, the minimum average energy (KV) shall be in accordance with 6.3.2. If the material thickness does not permit machining either full-size or standard subsize specimens, the testing procedure and acceptance standards shall be in accordance with recognized standards.

6.5.3.6 Procedure tests for fillet welding shall be in accordance with recognized standards. In such cases, consumables shall be so selected that exhibit satisfactory impact properties.

6.5.4 *Welding procedure tests for piping*

Welding procedure tests for piping shall be carried out and shall be similar to those detailed for cargo tanks in 6.5.3.

6.5.5 *Production weld tests*

6.5.5.1 For all cargo tanks and process pressure vessels, except integral and membrane tanks, production weld tests shall generally be performed for approximately each 50 m of butt-weld joints and shall be representative of each welding position. For secondary barriers, the same type production tests as required for primary tanks shall be performed, except that the number of tests may be reduced subject to agreement with the Administration. Tests, other than those specified in 6.5.5.2 to 6.5.5.5 may be required for cargo tanks or secondary barriers.

6.5.5.2 The production tests for type A and type B independent tanks and semi-membrane tanks shall include bend tests and, where required for procedure tests, one set of three Charpy V-notch tests. The tests shall be made for each 50 m of weld. The Charpy V-notch tests shall be made with specimens having the notch alternately located in the centre of the weld and in the heat-affected zone (most critical location based on procedure qualification results). For austenitic stainless steel, all notches shall be in the centre of the weld.

6.5.5.3 For type C independent tanks and process pressure vessels, transverse weld tensile tests are required in addition to the tests listed in 6.5.5.2. Tensile tests shall meet the requirements of 6.5.3.5.

6.5.5.4 The quality assurance/quality control programme shall ensure the continued conformity of the production welds as defined in the material manufacturers quality manual.

6.5.5.5 The test requirements for integral and membrane tanks are the same as the applicable test requirements listed in 6.5.3.

6.5.6 *Non-destructive testing*

6.5.6.1 All test procedures and acceptance standards shall be in accordance with recognized standards, unless the designer specifies a higher standard in order to meet design assumptions. Radiographic testing shall be used, in principle, to detect internal defects. However, an approved

ultrasonic test procedure in lieu of radiographic testing may be conducted, but, in addition, supplementary radiographic testing at selected locations shall be carried out to verify the results. Radiographic and ultrasonic testing records shall be retained.

6.5.6.2 For type A independent tanks and semi-membrane tanks, where the design temperature is below -20°C, and for type B independent tanks, regardless of temperature, all full penetration butt welds of the shell plating of cargo tanks shall be subjected to non-destructive testing suitable to detect internal defects over their full length. Ultrasonic testing in lieu of radiographic testing may be carried out under the same conditions as described in 6.5.6.1.

6.5.6.3 Where the design temperature is higher than -20°C, all full penetration butt welds in way of intersections and at least 10% of the remaining full penetration welds of tank structures shall be subjected to radiographic testing or ultrasonic testing under the same conditions as described in 6.5.6.1.

6.5.6.4 In each case, the remaining tank structure, including the welding of stiffeners and other fittings and attachments, shall be examined by magnetic particle or dye penetrant methods, as considered necessary.

6.5.6.5 For type C independent tanks, the extent of non-destructive testing shall be total or partial according to recognized standards, but the controls to be carried out shall not be less than the following:

.1 Total non-destructive testing referred to in 4.23.2.1.3:

Radiographic testing:

.1 all butt welds over their full length;

Non-destructive testing for surface crack detection:

.2 all welds over 10% of their length;

.3 reinforcement rings around holes, nozzles, etc., over their full length.

As an alternative, ultrasonic testing as described in 6.5.6.1 may be accepted as a partial substitute for the radiographic testing. In addition, the Administration may require total ultrasonic testing on welding of reinforcement rings around holes, nozzles, etc.

.2 Partial non-destructive testing referred to in 4.23.2.1.3:

Radiographic testing:

.1 all butt-welded crossing joints and at least 10% of the full length of butt welds at selected positions uniformly distributed;

Non-destructive testing for surface crack detection:

.2 reinforcement rings around holes, nozzles, etc., over their full length;

Ultrasonic testing:

.3 as may be required by the Administration or recognized organization acting on its behalf in each instance.

6.5.6.6 The quality assurance/quality control programme shall ensure the continued conformity of the non-destructive testing of welds, as defined in the material manufacturer's quality manual.

6.5.6.7 Inspection of piping shall be carried out in accordance with the requirements of Chapter 5.

6.5.6.8 The secondary barrier shall be non-destructive tested for internal defects as considered necessary. Where the outer shell of the hull is part of the secondary barrier, all sheer strake butts and the intersections of all butts and seams in the side shell shall be tested by radiographic testing.

6.6 Other requirements for construction in metallic materials

6.6.1 General

6.6.1.1 Inspection and non-destructive testing of welds shall be in accordance with the requirements of 6.5.5 and 6.5.6. Where higher standards or tolerances are assumed in the design, they shall also be satisfied.

6.6.2 Independent tank

6.6.2.1 For type C tanks and type B tanks primarily constructed of bodies of revolution, the tolerances relating to manufacture, such as out-of-roundness, local deviations from the true form, welded joints alignment and tapering of plates having different thicknesses, shall comply with recognized standards. The tolerances shall also be related to the buckling analysis referred to in 4.22.3.2 and 4.23.3.2.

6.6.2.2 For type C tanks of carbon and carbon-manganese steel, post-weld heat treatment shall be performed after welding, if the design temperature is below -10°C . Post-weld heat treatment in all other cases and for materials other than those mentioned above shall be to recognized standards. The soaking temperature and holding time shall be to the recognized standards.

6.6.2.3 In the case of type C tanks and large cargo pressure vessels of carbon or carbon-manganese steel, for which it is difficult to perform the heat treatment, mechanical stress relieving by pressurizing may be carried out as an alternative to the heat treatment and subject to the following conditions:

- .1** complicated welded pressure vessel parts such as sumps or domes with nozzles, with adjacent shell plates shall be heat treated before they are welded to larger parts of the pressure vessel;
- .2** the mechanical stress relieving process shall preferably be carried out during the hydrostatic pressure test required by 4.23.6, by applying a higher pressure than the test pressure required by 4.23.6.1. The pressurizing medium shall be water;
- .3** for the water temperature, 4.23.6.2 applies;
- .4** stress relieving shall be performed while the tank is supported by its regular saddles or supporting structure or, when stress relieving cannot be carried out on board, in a manner which will give the same stresses and stress distribution as when supported by its regular saddles or supporting structure;
- .5** the maximum stress relieving pressure shall be held for 2 h per 25 mm of thickness, but in no case less than 2 h;
- .6** the upper limits placed on the calculated stress levels during stress relieving shall be the following:
 - .1** equivalent general primary membrane stress: $0.9 R_e$;
 - .2** equivalent stress composed of primary bending stress plus membrane stress: $1.35 R_e$, where R_e is the specific lower minimum yield stress or 0.2% proof stress at test temperature of the steel used for the tank;
- .7** strain measurements will normally be required to prove these limits for at least the first tank of a series of identical tanks built consecutively. The location of strain gauges shall be included in the mechanical stress relieving procedure to be submitted in accordance with 6.6.2.3;

- .8 the test procedure shall demonstrate that a linear relationship between pressure and strain is achieved at the end of the stress relieving process when the pressure is raised again up to the design pressure;
- .9 high-stress areas in way of geometrical discontinuities such as nozzles and other openings shall be checked for cracks by dye penetrant or magnetic particle inspection after mechanical stress relieving. Particular attention in this respect shall be paid to plates exceeding 30 mm in thickness;
- .10 steels which have a ratio of yield stress to ultimate tensile strength greater than 0.8 shall generally not be mechanically stress relieved. If, however, the yield stress is raised by a method giving high ductility of the steel, slightly higher rates may be accepted upon consideration in each case;
- .11 mechanical stress relieving cannot be substituted for heat treatment of cold formed parts of tanks, if the degree of cold forming exceeds the limit above which heat treatment is required;
- .12 the thickness of the shell and heads of the tank shall not exceed 40 mm. Higher thicknesses may be accepted for parts which are thermally stress relieved;
- .13 local buckling shall be guarded against, particularly when tori-spherical heads are used for tanks and domes; and
- .14 the procedure for mechanical stress relieving shall be to a recognized standard.

6.6.3 Secondary barriers

During construction, the requirements for testing and inspection of secondary barriers shall be approved or accepted by the Administration or recognized organization acting on its behalf (see 4.6.2.5 and 4.6.2.6).

6.6.4 Semi-membrane tanks

For semi-membrane tanks, the relevant requirements in section 6.6 for independent tanks or for membrane tanks shall be applied as appropriate.

6.6.5 Membrane tanks

The quality assurance/quality control programme shall ensure the continued conformity of the weld procedure qualification, design details, materials, construction, inspection and production testing of components. These standards and procedures shall be developed during the prototype testing programme.

6.7 Non-metallic materials

6.7.1 General

The information in the attached Appendix 4 is given for guidance in the selection and use of these materials, based on the experience to date.

CHAPTER 7

(IGC Code Chapter 7)

Goal

To maintain the cargo tank pressure and temperature within design limits of the containment system and/or carriage requirements of the cargo.

7 CARGO PRESSURE/TEMPERATURE CONTROL**7.1 Methods of control**

7.1.1 With the exception of tanks designed to withstand full gauge vapour pressure of the cargo under conditions of the upper ambient design temperatures, cargo tanks' pressure and temperature shall be maintained at all times within their design range by either one, or a combination of, the following methods:

- .1 reliquefaction of cargo vapours;
- .2 thermal oxidation of vapours;
- .3 pressure accumulation; and
- .4 liquid cargo cooling.

7.1.2 For certain cargoes, where required by Chapter 17, the cargo containment system shall be capable of withstanding the full vapour pressure of the cargo under conditions of the upper ambient design temperatures, irrespective of any system provided for dealing with boil-off gas.

7.1.3 (...)

7.2 Design of systems

For normal service, the upper ambient design temperature shall be:

- sea: 32°C
- air: 45°C

For service in particularly hot or cold zones, these design temperatures shall be increased or decreased, to the satisfaction of the Administration. The overall capacity of the system shall be such that it can control the pressure within the design conditions without venting to atmosphere.

7.3 Reliquefaction of cargo vapours**7.3.1 General**

The reliquefaction system may be arranged in one of the following ways:

- .1 a direct system, where evaporated cargo is compressed, condensed and returned to the cargo tanks;
- .2 an indirect system, where cargo or evaporated cargo is cooled or condensed by refrigerant without being compressed;
- .3 a combined system, where evaporated cargo is compressed and condensed in a cargo/refrigerant heat exchanger and returned to the cargo tanks; and
- .4 if the reliquefaction system produces a waste stream containing methane during pressure control operations within the design conditions, these waste gases, as far as reasonably practicable, are disposed of without venting to atmosphere.

Note:

The requirements of Chapters 17 and 19 may preclude the use of one or more of these systems or may specify the use of a particular system.

7.3.2 *Compatibility*

Refrigerants used for reliquefaction shall be compatible with the cargo they may come into contact with. In addition, when several refrigerants are used and may come into contact, they shall be compatible with each other.

7.4 **Thermal oxidation of vapours**

7.4.1 *General*

Maintaining the cargo tank pressure and temperature by means of thermal oxidation of cargo vapours, as defined in 1.2.52 and 16.2 shall be permitted only for LNG cargoes. In general:

- .1 thermal oxidation systems shall exhibit no externally visible flame and shall maintain the uptake exhaust temperature below 535°C;
- .2 arrangement of spaces where oxidation systems are located shall comply with 16.3 and supply systems shall comply with 16.4; and
- .3 if waste gases coming from any other system are to be burnt, the oxidation system shall be designed to accommodate all anticipated feed gas compositions.

7.4.2 *Thermal oxidation systems*

Thermal oxidation systems shall comply with the following:

- .1 each thermal oxidation system shall have a separate uptake;
- .2 each thermal oxidation system shall have a dedicated forced draught system; and
- .3 combustion chambers and uptakes of thermal oxidation systems shall be designed to prevent any accumulation of gas.

7.4.3 *Burners*

Burners shall be designed to maintain stable combustion under all design firing conditions.

7.4.4 *Safety*

7.4.4.1 Suitable devices shall be installed and arranged to ensure that gas flow to the burner is cut off unless satisfactory ignition has been established and maintained.

7.4.4.2 Each oxidation system shall have provision to manually isolate its gas fuel supply from a safely accessible position.

7.4.4.3 Provision shall be made for automatic purging the gas supply piping to the burners by means of an inert gas, after the extinguishing of these burners.

7.4.4.4 In case of flame failure of all operating burners for gas or oil or for a combination thereof, the combustion chambers of the oxidation system shall be automatically purged before relighting.

7.4.4.5 Arrangements shall be made to enable the combustion chamber to be manually purged.

7.5 **Pressure accumulation systems**

The containment system insulation, design pressure or both shall be adequate to provide for a suitable margin for the operating time and temperatures involved. No additional pressure and temperature control system is required. Conditions for acceptance shall be recorded in the *International Certificate of Fitness for the Carriage of Liquefied Gases in Bulk* required in 1.4.4.

7.6 **Liquid cargo cooling**

The bulk cargo liquid may be refrigerated by coolant circulated through coils fitted either inside the cargo tank or onto the external surface of the cargo tank.

7.7 Segregation

Where two or more cargoes that may react chemically in a dangerous manner are carried simultaneously, separate systems as defined in 1.2.47, each complying with availability criteria as specified in 7.8, shall be provided for each cargo. For simultaneous carriage of two or more cargoes that are not reactive to each other but where, due to properties of their vapour, separate systems are necessary, separation may be by means of isolation valves.

7.8 Availability

The availability of the system and its supporting auxiliary services shall be such that:

- .1 in case of a single failure of a mechanical non-static component or a component of the control systems, the cargo tanks' pressure and temperature can be maintained within their design range without affecting other essential services;
 - .2 redundant piping systems are not required;
 - .3 heat exchangers that are solely necessary for maintaining the pressure and temperature of the cargo tanks within their design ranges shall have a standby heat exchanger, unless they have a capacity in excess of 25% of the largest required capacity for pressure control and they can be repaired on board without external resources. Where an additional and separate method of cargo tank pressure and temperature control is fitted that is not reliant on the sole heat exchanger, then a standby heat exchanger is not required; and
 - .4 for any cargo heating or cooling medium, provisions shall be made to detect the leakage of toxic or flammable vapours into an otherwise non-hazardous area or overboard in accordance with 13.6. Any vent outlet from this leak detection arrangement shall be to a safe location and be fitted with a flame screen.
-

CHAPTER 8
(IGC Code Chapter 8)

Goal

To protect cargo containment systems from harmful overpressure or underpressure at all times.

8 VENT SYSTEMS FOR CARGO CONTAINMENT

8.1 General

All cargo tanks shall be provided with a pressure relief system appropriate to the design of the cargo containment system and the cargo being carried. Hold spaces and interbarrier spaces, which may be subject to pressures beyond their design capabilities, shall also be provided with a suitable pressure relief system. Pressure control systems specified in Chapter 7 shall be independent of the pressure relief systems.

IACS interpretation

Guidance for sizing pressure relief systems for interbarrier spaces

1 General

- 1.1** *The formula for determining the relieving capacity given in section 2 is for interbarrier spaces surrounding independent type A cargo tanks, where the thermal insulation is fitted to the cargo tanks.*
- 1.2** *The relieving capacity of pressure relief devices of interbarrier spaces surrounding independent type B cargo tanks may be determined on the basis of the method given in section 2, however, the leakage rate is to be determined in accordance with 4.7.2 (4.7.2 of the IGC Code).*
- 1.3** *The relieving capacity of pressure relief devices for interbarrier spaces of membrane and semi-membrane tanks is to be evaluated on the basis of specific membrane/semimembrane tank design.*
- 1.4** *The relieving capacity of pressure relief devices for interbarrier spaces adjacent to integral type cargo tanks may, if applicable, be determined as for type A independent cargo tanks.*

2 Size of pressure relief devices

The combined relieving capacity of the pressure relief devices for interbarrier spaces surrounding type A independent cargo tanks where the insulation is fitted to the cargo tanks may be determined by the following formula:

$$Q_{sa} = 3,4 \cdot A_c \frac{\rho}{\rho_v} \sqrt{h} \quad (\text{m}^3/\text{s})$$

where:

Q_{sa} = minimum required discharge rate of air at standard conditions of 273 K and 1.013 bar

A_c = design crack opening area (m²)

$A_c = \frac{\pi}{4} \cdot \delta \cdot l$ (m²)

δ = max, crack opening width (m)

$\delta = 0,2 \cdot t$ (m)

t = thickness of tank bottom plating (m)

l = design crack length (m) equal to the diagonal of the largest plate panel of the tank bottom, see sketch below.

h = max liquid height above tank bottom plus 10·MARVS (m)

ρ = density of product liquid phase (kg/m³) at the set pressure of the interbarrier space relief device

ρ_v = density of product vapour phase (kg/m³) at the set pressure of the interbarrier space relief device and a temperature of 273 K

MARVS = max allowable relief valve setting of the cargo tank (bar).

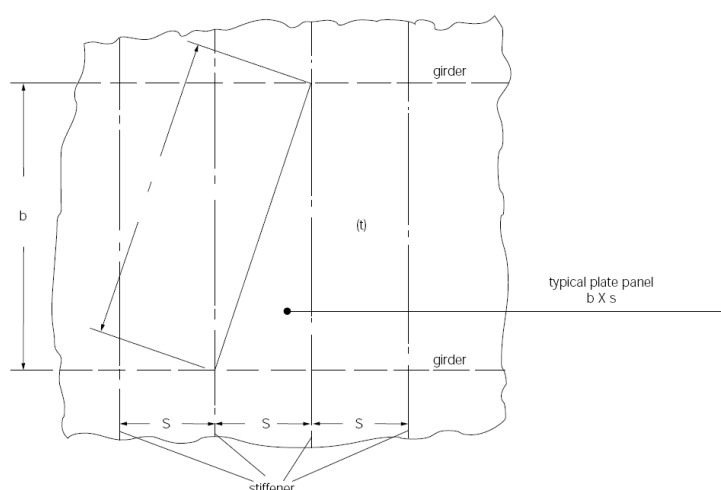

(IACS UI GC28)

8.2 Pressure relief systems

8.2.1 Cargo tanks, including deck tanks, shall be fitted with a minimum of two pressure relief valves (PRVs), each being of equal size within manufacturer's tolerances and suitably designed and constructed for the prescribed service.

8.2.2 Interbarrier spaces shall be provided with pressure relief devices ⁸. For membrane systems, the designer shall demonstrate adequate sizing of interbarrier space PRVs.

⁸ Refer to IACS Unified Interpretation GC9 entitled "Guidance for sizing pressure relief systems for interbarrier spaces"

IACS interpretation

Guidance for sizing pressure relief systems for interbarrier spaces

1 General

- 1.1** The formula for determining the relieving capacity given in section 2 is developed for interbarrier spaces surrounding independent type A cargo tanks, where the thermal insulation is fitted to the cargo tanks.
- 1.2** The relieving capacity of pressure relief devices of interbarrier spaces surrounding independent type B cargo tanks may be determined on the basis of the method given in section 2, however, the leakage rate is to be determined in accordance with 4.7.6.1 (4.7.6.1 of the IGC Code).
- 1.3** The relieving capacity of pressure relief devices for interbarrier spaces of membrane and semi-membrane tanks is to be evaluated on the basis of specific membrane/semimembrane tank design.
- 1.4** The relieving capacity of pressure relief devices for interbarrier spaces adjacent to integral type cargo tanks may, if applicable, be determined as for type A independent cargo tanks.

2 Size of pressure relief devices

The combined relieving capacity of the pressure relief devices for interbarrier spaces surrounding type A independent cargo tanks where the insulation is fitted to the cargo tanks may be determined by the following formula:

$$Q_{sa} = 3,4 \cdot A_c \frac{\rho}{\rho_v} \sqrt{h} \quad (\text{m}^3/\text{s})$$

where:

Q_{sa} = minimum required discharge rate of air at standard conditions of 273 K and 1.013 bar

A_c = design crack opening area (m^2)

$A_c = \frac{\pi}{4} \cdot \delta \cdot l$ (m^2)

δ = max, crack opening width (m)

$\delta = 0,2 \cdot t$ (m)

t = thickness of tank bottom plating (m)

- l = design crack length (m) equal to the diagonal of the largest plate panel of the tank bottom, see sketch below.
 h = max liquid height above tank bottom plus 10·MARVS (m)
 ρ = density of product liquid phase (kg/m³) at the set pressure of the interbarrier space relief device
 ρ_v = density of product vapour phase (kg/m³) at the set pressure of the interbarrier space relief device and a temperature of 273 K
MARVS = max allowable relief valve setting of the cargo tank (bar).

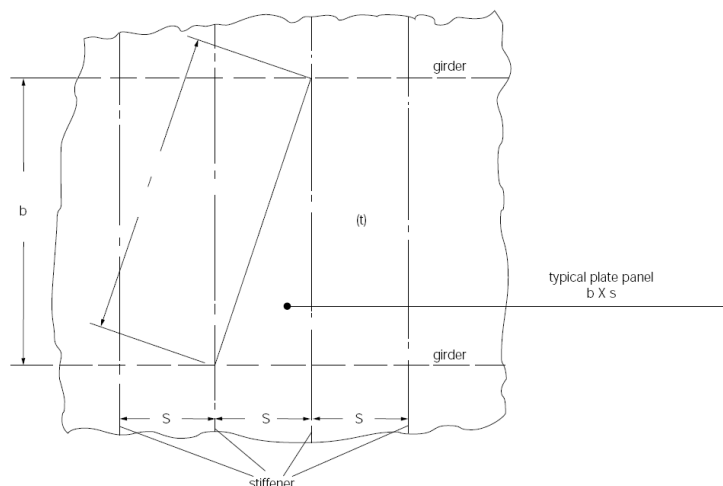

(IACS UI GC9)

8.2.3 The setting of the PRVs shall not be higher than the vapour pressure that has been used in the design of the tank. Where two or more PRVs are fitted, valves comprising not more than 50% of the total relieving capacity may be set at a pressure up to 5% above MARVS to allow sequential lifting, minimizing unnecessary release of vapour.

8.2.4 The following temperature requirements apply to PRVs fitted to pressure relief systems:

- .1 PRVs on cargo tanks with a design temperature below 0°C shall be designed and arranged to prevent their becoming inoperative due to ice formation;
- .2 the effects of ice formation due to ambient temperatures shall be considered in the construction and arrangement of PRVs;
- .3 PRVs shall be constructed of materials with a melting point above 925°C. Lower melting point materials for internal parts and seals may be accepted, provided that fail-safe operation of the PRV is not compromised; and
- .4 sensing and exhaust lines on pilot operated relief valves shall be of suitably robust construction to prevent damage.

8.2.5 Valve testing

8.2.5.1 PRVs shall be type-tested. Type tests shall include:

- .1 verification of relieving capacity;
- .2 cryogenic testing when operating at design temperatures colder than -55°C;
- .3 seat tightness testing; and
- .4 pressure containing parts are pressure tested to at least 1.5 times the design pressure.

PRVs shall be tested in accordance with recognized standards ⁹.

⁹ ISO 21013-1:2008 – Cryogenic vessels – Pressure-relief accessories for cryogenic service – part 1: Recloseable pressure-relief valves; and ISO 4126-1; 2004 Safety devices for protection against excessive pressure – part 1 and part 4: Safety valves.

8.2.5.2 Each PRV shall be tested to ensure that:

- .1 it opens at the prescribed pressure setting, with an allowance not exceeding $\pm 10\%$ for 0 to 0.15 MPa, $\pm 6\%$ for 0.15 to 0.3 MPa, $\pm 3\%$ for 0.3 MPa and above;
- .2 seat tightness is acceptable; and
- .3 pressure containing parts will withstand at least 1.5 times the design pressure.

8.2.6 PRVs shall be set and sealed by the Administration or recognized organization acting on its behalf, and a record of this action, including the valves' set pressure, shall be retained on board the ship.

8.2.7 Cargo tanks may be permitted to have more than one relief valve set pressure in the following cases:

- .1 installing two or more properly set and sealed PRVs and providing means, as necessary, for isolating the valves not in use from the cargo tank; or
- .2 installing relief valves whose settings may be changed by the use of a previously approved device not requiring pressure testing to verify the new set pressure. All other valve adjustments shall be sealed.

8.2.8 Changing the set pressure under the provisions of 8.2.7 and the corresponding resetting of the alarms referred to in 13.4.2 shall be carried out under the supervision of the master in accordance with approved procedures and as specified in the ship's operating manual. Changes in set pressure shall be recorded in the ship's log and a sign shall be posted in the cargo control room, if provided, and at each relief valve, stating the set pressure.

8.2.9 In the event of a failure of a cargo tank-installed PRV, a safe means of emergency isolation shall be available:

- .1 Procedures shall be provided and included in the cargo operations manual (see 18.2).
- .2 The procedures shall allow only one of the cargo tank installed PRVs to be isolated.
- .3 (...)
- .4 (...)

IMO interpretation

The "safe means of emergency isolation", as required by paragraph 8.2.9, should be provided so that a PRV can be isolated on a temporary basis to reseal or repair the valve before putting the PRV back into service. Such means of emergency isolation should be installed in a manner that does not allow their inadvertent operation. (MSC.1/Circ.1559)

8.2.10 8.2.10 Each PRV installed on a cargo tank shall be connected to a venting system, which shall be:

- .1 so constructed that the discharge will be unimpeded and directed vertically upwards at the exit;
- .2 arranged to minimize the possibility of water or snow entering the vent system;
- .3 arranged such that the height of vent exits shall not be less than B/3 or 6 m, whichever is the greater, above the weather deck; and
- .4 6 m above working areas and walkways.

8.2.11 Distances from air intakes and other openings

8.2.11.1 Cargo PRV vent exits shall be arranged at a distance at least equal to B or 25 m, whichever is less, from the nearest air intake, outlet or opening to accommodation spaces, service spaces and control stations, or other non-hazardous areas. For ships less than 90 m in length, smaller distances may be permitted.

8.2.11.2 All other vent outlets connected to the cargo containment system shall be arranged at a distance of at least 10 m from the nearest air intake, outlet or opening to accommodation spaces, service spaces and control stations, or other non-hazardous areas.

8.2.12 All other cargo vent outlets not dealt with in other chapters shall be arranged in accordance with 8.2.10, 8.2.11.1 and 8.2.11.2. Means shall be provided to prevent liquid overflow from vent mast outlets, due to hydrostatic pressure from spaces to which they are connected.

8.2.13 If cargoes that react in a dangerous manner with each other are carried simultaneously, a separate pressure relief system shall be fitted for each one.

8.2.14 In the vent piping system, means for draining liquid from places where it may accumulate shall be provided. The PRVs and piping shall be arranged so that liquid can, under no circumstances, accumulate in or near the PRVs.

8.2.15 Suitable protection screens of not more than 13 mm square mesh shall be fitted on vent outlets to prevent the ingress of extraneous objects without adversely affecting the flow. Other requirements for protection screens apply when carrying specific cargoes (see 17.9 and 17.21).

8.2.16 All vent piping shall be designed and arranged not to be damaged by the temperature variations to which it may be exposed, forces due to flow or the ship's motions.

8.2.17 PRVs shall be connected to the highest part of the cargo tank above deck level. PRVs shall be positioned on the cargo tank so that they will remain in the vapour phase at the filling limit (*FL*) as defined in Chapter 15, under conditions of 15° list and 0.015*L* trim, where *L* is defined in 1.2.31.

IACS recommendation

*Under normal operating conditions, the vapour space is continuous and in communication with the vapour/liquid domes where the vapour line and cargo tank pressure relief valves (PRVs) are located. However, due to the geometry of the tank there may be times when a vapour pocket can be formed in a cargo tank on a liquefied gas carrier which is not in communication with the vapour/liquid domes. The vast majority of these conditions occur in a dynamic condition and are dissipated by the motion of the ship. However, there can be situations where the pocket exists in a static condition, for instance, due to damage to the ship caused by an accident such as grounding or collision. Even though the Rules (IGC Code) states that the PRVs should be in the vapour phase under conditions of 15° list and 0.015*L* trim and presumes that no isolated vapour pockets are formed within this range in principle, this scenario can occur at other trim and list values based upon the filling level of the tank since the ship is designed to survive a damage condition up to 30° of list.*

In this condition, there is the potential for liquid build-up in the vapour/liquid domes caused by a pressure differential between the isolated vapour pocket and the vapour/liquid domes resulting in a possible overflow of cargo liquid into the vapour line or into the tank PRVs. Even though the likelihood of this situation occurring may be minimal, the consequences could be quite severe and lead up to the loss of the ship. Owners/operators of liquefied gas carriers, in consultation with the cargo containment system/cargo handling system designers, are recommended to develop emergency procedures to mitigate the risks to the vessel caused by isolated vapour pockets. These procedures should identify the condition when isolated vapour pockets can be present and contain measures to reduce or eliminate them and/or mitigate their consequences such as cargo jettisoning, transfer of cargo between tanks, and cargo vapourization/utilization based upon different scenarios following the accident, including, but not limited to, loss of power, limited ability to reduce angle of heel or trim.

These emergency procedures are not a substitute for requirement 15.4.1.1 when determining the increased filling limits. (IACS REC. 150)

8.2.18 The adequacy of the vent system fitted on tanks loaded in accordance with 15.5.2 shall be demonstrated, taking into account the recommendations developed by the Organization¹⁰. A relevant certificate shall be permanently kept on board the ship. For the purposes of this paragraph, vent system means:

- .1 the tank outlet and the piping to the PRV;



- .2 the PRV; and
- .3 the piping from the PRVs to the location of discharge to the atmosphere, including any interconnections and piping that joins other tanks.

¹⁰ Refer to the *Guidelines for the evaluation of the adequacy of type C tank vent systems* (resolution A.829(19)).

8.3 Vacuum protection systems

8.3.1 Cargo tanks not designed to withstand a maximum external pressure differential 0.025 MPa, or tanks that cannot withstand the maximum external pressure differential that can be attained at maximum discharge rates with no vapour return into the cargo tanks, or by operation of a cargo refrigeration system, or by thermal oxidation, shall be fitted with:

- .1 two independent pressure switches to sequentially alarm and subsequently stop all suction of cargo liquid or vapour from the cargo tank and refrigeration equipment, if fitted, by suitable means at a pressure sufficiently below the maximum external designed pressure differential of the cargo tank; or
- .2 vacuum relief valves with a gas flow capacity at least equal to the maximum cargo discharge rate per cargo tank, set to open at a pressure sufficiently below the external design differential pressure of the cargo tank.

8.3.2 Subject to the requirements of Chapter 17, the vacuum relief valves shall admit an inert gas, cargo vapour or air to the cargo tank and shall be arranged to minimize the possibility of the entrance of water or snow. If cargo vapour is admitted, it shall be from a source other than the cargo vapour lines.

8.3.3 The vacuum protection system shall be capable of being tested to ensure that it operates at the prescribed pressure.

8.4 Sizing of pressure relieving system

8.4.1 Sizing of pressure relief valves

PRVs shall have a combined relieving capacity for each cargo tank to discharge the greater of the following, with not more than a 20% rise in cargo tank pressure above the MARVS:

8.4.1.1 The maximum capacity of the cargo tank inerting system, if the maximum attainable working pressure of the cargo tank inerting system exceeds the MARVS of the cargo tanks; or

8.4.1.2 Vapours generated under fire exposure computed using the following formula:

$$Q = FGA^{0.82} \text{ (m}^3\text{/s)}$$

where:

Q = minimum required rate of discharge of air at standard conditions of 273.15 Kelvin (K) and 0.1013 MPa;

F = fire exposure factor for different cargo types as follows:

- 1 for tanks without insulation located on deck;
- 0.5 for tanks above the deck, when insulation is approved by the Administration. Approval will be based on the use of a fireproofing material, the thermal conductance of insulation and its stability under fire exposure;
- 0.5 for uninsulated independent tanks installed in holds;
- 0.2 for insulated independent tanks in holds (or uninsulated independent tanks in insulated holds);

- 0.1 for insulated independent tanks in inerted holds (or uninsulated independent tanks in inerted, insulated holds);
- 0.1 for membrane and semi-membrane tanks. For independent tanks partly protruding through the weather decks, the fire exposure factor shall be determined on the basis of the surface areas above and below deck.

G = gas factor according to formula:

$$G = \frac{12.4}{LD} \sqrt{\frac{ZT}{M}}$$

with:

T = temperature in degrees Kelvin at relieving conditions, i.e. 120% of the pressure at which the pressure relief valve is set;

L = latent heat of the material being vaporized at relieving conditions, in kJ/kg;

D = a constant based on relation of specific heats k and is calculated as follows:

$$D = \sqrt{k \left(\frac{2}{k+1} \right)^{\frac{k+1}{k-1}}}$$

where:

k = ratio of specific heats at relieving conditions, and the value of which is between 1 and 2.2. If k is not known, $D = 0.606$ shall be used;

Z = compressibility factor of the gas at relieving conditions. If not known, $Z = 1$ shall be used; and

M = molecular mass of the product.

The gas factor of each cargo to be carried shall be determined and the highest value shall be used for PRV sizing.

A = external surface area of the tank (m²), as defined in 1.2.14, for different tank types, as shown in figure 8.1.

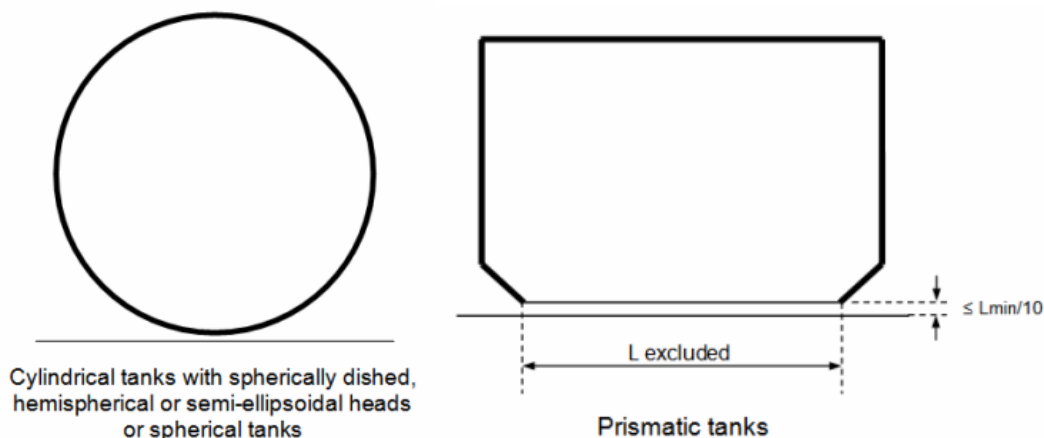

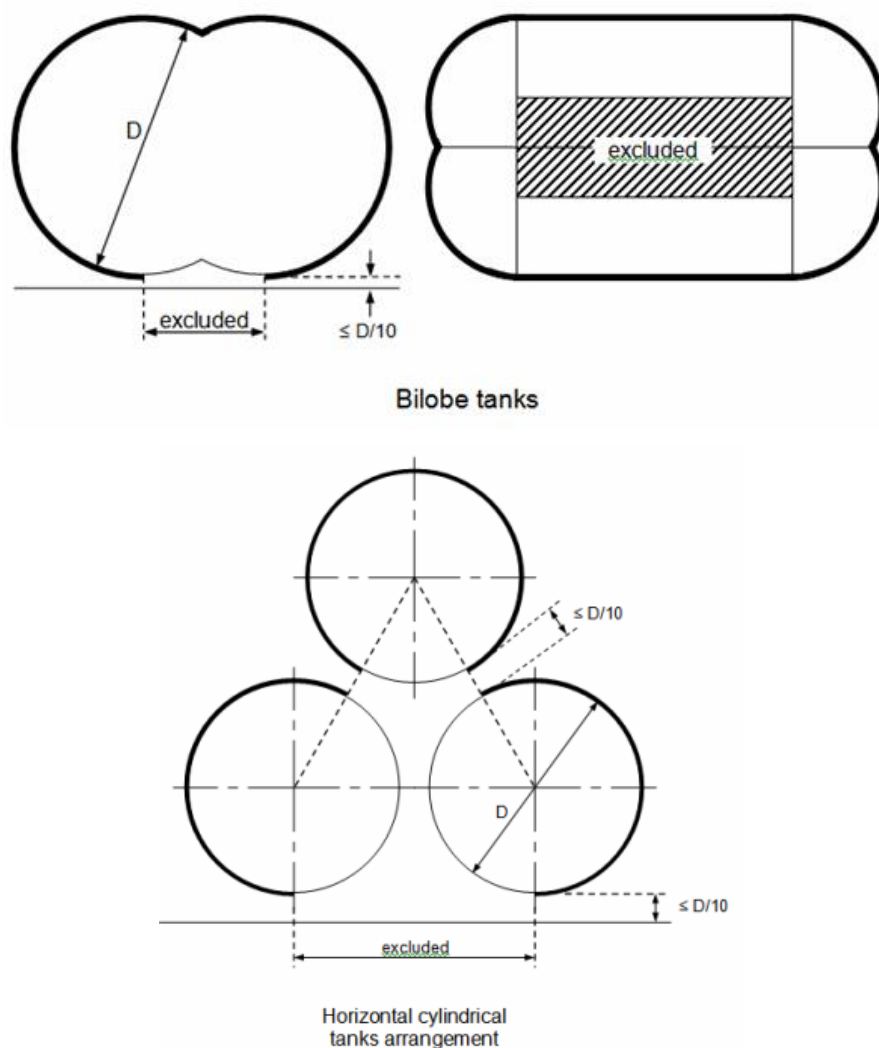

Figure 8.1

IACS and IMO interpretation

External surface area of the tank for determining sizing of pressure relief valve (paragraph 8.4.1.2 and figure 8.1)

For prismatic tanks

L_{min} , for non-tapered tanks, is the smaller of the horizontal dimensions of the flat bottom of the tank. For tapered tanks, as would be used for the forward tank, L_{min} is the smaller of the length and the average width.

For prismatic tanks whose distance between the flat bottom of the tank and bottom of the hold space is equal to or less than $L_{min}/10$:

A = external surface area minus flat bottom surface area.

For prismatic tanks whose distance between the flat bottom of the tank and bottom of the hold space is greater than $L_{min}/10$:

A = external surface area. (IACS UI GC19, MSC.1/Circ.1559)

8.4.1.3 The required mass flow of air at relieving conditions is given by the formula:

$$M_{air} = Q\rho_{air} \text{ (kg/s),}$$

where:

density of air (ρ_{air}) = 1.293 kg/m³ (air at 273.15 K, 0.1013 MPa).

8.4.2 Sizing of vent pipe system

Pressure losses upstream and downstream of the PRVs shall be taken into account when determining their size to ensure the flow capacity required by 8.4.1.

8.4.3 Upstream pressure losses

8.4.3.1 The pressure drop in the vent line from the tank to the PRV inlet shall not exceed 3% of the valve set pressure at the calculated flow rate, in accordance with 8.4.1.

8.4.3.2 Pilot-operated PRVs shall be unaffected by inlet pipe pressure losses when the pilot senses directly from the tank dome.

8.4.3.3 Pressure losses in remotely sensed pilot lines shall be considered for flowing type pilots.

8.4.4 Downstream pressure losses

8.4.4.1 Where common vent headers and vent masts are fitted, calculations shall include flow from all attached PRVs.

8.4.4.2 The built-up back pressure in the vent piping from the PRV outlet to the location of discharge to the atmosphere, and including any vent pipe interconnections that join other tanks, shall not exceed the following values:

- .1** for unbalanced PRVs: 10% of MARVS;
- .2** for balanced PRVs: 30% of MARVS; and
- .3** for pilot operated PRVs: 50% of MARVS.

Alternative values provided by the PRV manufacturer may be accepted.

8.4.5 To ensure stable PRV operation, the blow-down shall not be less than the sum of the inlet pressure loss and 0.02 MARVS at the rated capacity.

CHAPTER 9

(IGC Code Chapter 9)

Goal

To enable monitoring of the integrity of the containment system and to ensure that the atmosphere within the system and hold spaces is maintained in a safe condition at all times that the ship is in service.

9 CARGO CONTAINMENT SYSTEM ATMOSPHERE CONTROL**9.1 Atmosphere control within the cargo containment system**

9.1.1 A piping system shall be arranged to enable each cargo tank to be safely gas-freed, and to be safely filled with cargo vapour from a gas-free condition. The system shall be arranged to minimize the possibility of pockets of gas or air remaining after changing the atmosphere.

9.1.2 For flammable cargoes, the system shall be designed to eliminate the possibility of a flammable mixture existing in the cargo tank during any part of the atmosphere change operation by utilizing an inerting medium as an intermediate step.

9.1.3 Piping systems that may contain flammable cargoes shall comply with 9.1.1 and 9.1.2.

9.1.4 A sufficient number of gas sampling points shall be provided for each cargo tank and cargo piping system to adequately monitor the progress of atmosphere change. Gas sampling connections shall be fitted with a single valve above the main deck, sealed with a suitable cap or blank (see 5.6.5.5).

9.1.5 Inert gas utilized in these procedures may be provided from the shore or from the ship.

9.2 Atmosphere control within the hold spaces (cargo containment systems other than type C independent tanks)

9.2.1 Interbarrier and hold spaces associated with cargo containment systems for flammable gases requiring full or partial secondary barriers shall be inerted with a suitable dry inert gas and kept inerted with make-up gas provided by a shipboard inert gas generation system, or by shipboard storage, which shall be sufficient for normal consumption for at least 30 days.

9.2.2 Alternatively, subject to the restrictions specified in Chapter 17, the spaces referred to in 9.2.1 requiring only a partial secondary barrier may be filled with dry air provided that the ship maintains a stored charge of inert gas or is fitted with an inert gas generation system sufficient to inert the largest of these spaces, and provided that the configuration of the spaces and the relevant vapour detection systems, together with the capability of the inerting arrangements, ensures that any leakage from the cargo tanks will be rapidly detected and inerting effected before a dangerous condition can develop. Equipment for the provision of sufficient dry air of suitable quality to satisfy the expected demand shall be provided.

9.2.3 For non-flammable gases, the spaces referred to in 9.2.1 and 9.2.2 may be maintained with a suitable dry air or inert atmosphere.

9.3 Environmental control of spaces surrounding type C independent tanks

Spaces surrounding cargo tanks that do not have secondary barriers shall be filled with suitable dry inert gas or dry air and be maintained in this condition with make-up inert gas provided by a shipboard inert gas generation system, shipboard storage of inert gas, or with dry air provided by suitable air drying equipment. If the cargo is carried at ambient temperature, the requirement for dry air or inert gas is not applicable.

9.4 Inerting

9.4.1 Inerting refers to the process of providing a non-combustible environment. Inert gases shall be compatible chemically and operationally at all temperatures likely to occur within the spaces and the cargo. The dew points of the gases shall be taken into consideration.

9.4.2 Where inert gas is also stored for firefighting purposes, it shall be carried in separate containers and shall not be used for cargo services.

9.4.3 Where inert gas is stored at temperatures below 0°C, either as a liquid or as a vapour, the storage and supply system shall be designed so that the temperature of the ship's structure is not reduced below the limiting values imposed on it.

9.4.4 Arrangements to prevent the backflow of cargo vapour into the inert gas system that are suitable for the cargo carried, shall be provided. If such plants are located in machinery spaces or other spaces outside the cargo area, two non-return valves or equivalent devices and, in addition, a removable spool piece shall be fitted in the inert gas main in the cargo area. When not in use, the inert gas system shall be made separate from the cargo system in the cargo area except for connections to the hold spaces or interbarrier spaces.

9.4.5 The arrangements shall be such that each space being inerted can be isolated and the necessary controls and relief valves, etc., shall be provided for controlling pressure in these spaces.

9.4.6 Where insulation spaces are continually supplied with an inert gas as part of a leak detection system, means shall be provided to monitor the quantity of gas being supplied to individual spaces.

9.5 Inert gas production on board

9.5.1 The equipment shall be capable of producing inert gas with an oxygen content at no time greater than 5% by volume, subject to the special requirements of Chapter 17. A continuous-reading oxygen content meter shall be fitted to the inert gas supply from the equipment and shall be fitted with an alarm set at a maximum of 5% oxygen content by volume, subject to the requirements of Chapter 17.

9.5.2 An inert gas system shall have pressure controls and monitoring arrangements appropriate to the cargo containment system.

9.5.3 Spaces containing inert gas generation plants shall have no direct access to accommodation spaces, service spaces or control stations, but may be located in machinery spaces. Inert gas piping shall not pass through accommodation spaces, service spaces or control stations.

9.5.4 Combustion equipment for generating inert gas shall not be located within the cargo area. Special consideration may be given to the location of inert gas generating equipment using a catalytic combustion process.

CHAPTER 10

(IGC Code Chapter 10)

Goal

To ensure that electrical installations are designed such as to minimize the risk of fire and explosion from flammable products, and that electrical generation and distribution systems relating to the safe carriage, handling and conditioning of cargo liquid and vapour are available.

10 ELECTRICAL INSTALLATIONS**10.1 Definitions**

For the purpose of this Chapter, unless expressly provided otherwise, the definitions below shall apply.

10.1.1 Hazardous area is an area in which an explosive gas atmosphere is or may be expected to be present, in quantities such as to require special precautions for the construction, installation and use of electrical apparatus ¹¹.

¹¹ Examples of hazardous area zoning may be found in the International Electrotechnical Commission publication IEC 60092-502:1999. *Electrical Installation in Ships – Tankers*.

10.1.1.1 Zone 0 hazardous area is an area in which an explosive gas atmosphere is present continuously or is present for long periods.

10.1.1.2 Zone 1 hazardous area is an area in which an explosive gas atmosphere is likely to occur in normal operation.

10.1.1.3 Zone 2 hazardous area is an area in which an explosive gas atmosphere is not likely to occur in normal operation and, if it does occur, is likely to do so infrequently and for a short period only.

10.1.1.4 Non-hazardous area is an area in which an explosive gas atmosphere is not expected to be present in quantities such as to require special precautions for the construction, installation and use of electrical apparatus.

10.2 General requirements

10.2.1 Electrical installations shall be such as to minimize the risk of fire and explosion from flammable products.

10.2.2 Electrical installations shall be in accordance with recognized standards. ¹²

¹² Refer to the recommendation published by the International Electrotechnical Commission in particular to publication IEC 60092-502:1999.

10.2.3 Electrical equipment or wiring shall not be installed in hazardous areas, unless essential for operational purposes or safety enhancement.

10.2.4 Where electrical equipment is installed in hazardous areas as provided in 10.2.3, it shall be selected, installed and maintained in accordance with standards not inferior to those acceptable to the Organization. Equipment for hazardous areas shall be evaluated and certified or listed by an accredited testing authority or notified body recognized by the Administration.

Automatic isolation of non-certified equipment on detection of a flammable gas shall not be accepted as an alternative to the use of certified equipment.

10.2.5 To facilitate the selection of appropriate electrical apparatus and the design of suitable electrical installations, hazardous areas are divided into zones in accordance with recognized standards.

10.2.6 Electrical generation and distribution systems, and associated control systems shall be designed such that a single fault will not result in the loss of ability to maintain cargo tank pressures, as required by 7.8.1, and hull structure temperature, as required by 4.19.1.6, within normal operating limits. Failure modes and effects shall be analysed and documented to a standard not inferior to those acceptable to the Administration ¹³.

¹³ IEC 60812, Edition 2.0 2006-01 "Analysis techniques for system reliability – Procedure for failure mode and effects analysis (FMEA)".

10.2.7 The lighting system in hazardous areas shall be divided between at least two branch circuits. All switches and protective devices shall interrupt all poles or phases and shall be located in a non-hazardous area.

10.2.8 Electrical depth sounding or log devices and impressed current cathodic protection system anodes or electrodes shall be housed in gastight enclosures.

10.2.9 Submerged cargo pump motors and their supply cables may be fitted in cargo containment systems. Arrangements shall be made to automatically shut down the motors in the event of low-liquid level. This may be accomplished by sensing low pump discharge pressure, low motor current or low liquid level. This shutdown shall be alarmed at the cargo control station. Cargo pump motors shall be capable of being isolated from their electrical supply during gas-freeing operations.

CHAPTER 11

(IGC Code Chapter 11)

Goal*To ensure that suitable systems are provided to protect the ship and crew from fire in the cargo area.***11 FIRE PROTECTION AND EXTINCTION****11.1 Fire safety requirements**

11.1.1 The requirements for tankers in SOLAS Chapter II-2 shall apply to ships covered by these *Rules* (the Code), irrespective of tonnage including ships of less than 500 gross tonnage, except that:

- .1 regulations 4.5.1.6 and 4.5.10 do not apply;
- .2 regulations 10.4 and 10.5 shall apply as they would apply to tankers of 2,000 gross tonnage and over;
- .3 regulation 10.5.6 shall apply to ships of 2,000 gross tonnage and over;
- .4 the following regulations of SOLAS Chapter II-2 related to tankers do not apply and are replaced by chapters and sections of these *Rules* (the Code) as detailed below:

<i>Regulation:</i>	<i>Replaced by:</i>
10.10	11.6
4.5.1.1 and 4.5.1.2	Chapter 3
4.5.5	Relevant sections in these <i>Rules</i> (the Code)
10.8	11.3 and 11.4
10.9	11.5
10.2	11.2.1 to 11.2.4;

- .5 regulations 13.3.4 and 13.4.3 shall apply to ships of 500 gross tonnage and over.

11.1.2 All sources of ignition shall be excluded from spaces where flammable vapour may be present, except as otherwise provided in Chapters 10 and 16.

11.1.3 The provisions of this section shall apply in conjunction with Chapter 3.

11.1.4 For the purposes of firefighting, any weather deck areas above cofferdams, ballast or void spaces at the after end of the aftermost hold space or at the forward end of the forwardmost hold space shall be included in the cargo area.

IACS interpretation***Deck areas above F.O. tanks installed at the after end of the aftermost hold space***

Where 'F.O. tanks' are installed at the after end of the aftermost hold space or at the forward end of the forwardmost hold space instead of cofferdams as allowed for in paragraphs 3.1.2 and 3.1.3 of the Rules (IGC Code), the weather deck area above these tanks shall be regarded as a 'cargo area' for the purpose of applying paragraph 11.3.6 of the Rules (IGC Code). (IACS UI GC38)

11.2 Fire mains and hydrants

11.2.1 Irrespective of size, ships carrying products that are subject to these *Rules* (the Code) shall comply with the requirements of regulation II-2/10.2 of the SOLAS Convention, as applicable to cargo ships, except that the required fire pump capacity and fire main and water service pipe diameter shall not be limited by the provisions of regulations II-2/10.2.2.4.1 and II-2/10.2.1.3,

when a fire pump is used to supply the water-spray system, as permitted by 11.3.3 of these *Rules* (the Code). The capacity of this fire pump shall be such that these areas can be protected when simultaneously supplying two jets of water from fire hoses with 19 mm nozzles at a pressure of at least 0.5 MPa gauge.

11.2.2 The arrangements shall be such that at least two jets of water can reach any part of the deck in the cargo area and those portions of the cargo containment system and tank covers that are above the deck. The necessary number of fire hydrants shall be located to satisfy the above arrangements and to comply with the requirements of regulations II-2/10.2.1.5.1 and II-2/10.2.3.3 of the SOLAS Convention, with hose lengths as specified in regulation II-2/10.2.3.1.1. In addition, the requirements of regulation II-2/10.2.1.6 shall be met at a pressure of at least 0.5 MPa gauge.

IACS and IMO interpretation (for paragraphs 11.2 and 11.3.4)

Emergency fire pump

1. In paragraph 11.3.4 the term "fire pumps" where not qualified by the word "emergency" and this term refers to the fire pumps required in accordance with SOLAS Reg.II-2/10.2.2.2.
2. If all the fire pumps mentioned in paragraph 1 above supplying the water spray system (for covering the superstructures and deckhouses) are disabled due to a fire in any one compartment; then the emergency fire pump shall be sized to cover:
 - .1 the water spray system for the boundaries of the superstructures and deckhouses, and lifeboats, liferafts and muster areas facing the cargo area, (as per paragraph 11.3.4); and
 - .2 two fire hydrants (as per paragraph 11.2).
3. When the ship is also fitted with a total flooding high expansion foam system protecting the engine-room (to comply with SOLAS II-2/10.4.1.1.2 and 10.5.1.1) and the emergency fire pump is intended to supply sea water to this system, then, the emergency fire pump shall also be sized to cover the foam system for dealing with an engine-room fire, when the main fire pumps are disabled.
4. On the basis of the principle of dealing with one single fire incident at a time, the emergency fire pump does not need to be sized to cover all three systems in 2 and 3 above (i.e. water spray, hydrants and foam) at the same time and shall need only be sized to cover the most demanding area and required systems, as follows:
 - .1 the foam system + two hydrants; or
 - .2 the water spray system + two hydrants;whichever is greater. (IACS UI GC30, MSC.1/Circ.1625)

11.2.3 Stop valves shall be fitted in any crossover provided and in the fire main or mains in a protected location, before entering the cargo area and at intervals ensuring isolation of any damaged single section of the fire main, so that 11.2.2 can be complied with using not more than two lengths of hoses from the nearest fire hydrant. The water supply to the fire main serving the cargo area shall be a ring main supplied by the main fire pumps or a single main supplied by fire pumps positioned fore and aft of the cargo area, one of which shall be independently driven.

11.2.4 Nozzles shall be of an approved dual-purpose type (i.e. spray/jet type) incorporating a shutoff.

11.2.5 After installation, the pipes, valves, fittings and assembled system shall be subject to a tightness and function test.

11.3 Water-spray system

11.3.1 On ships carrying flammable and/or toxic products, a water-spray system, for cooling, fire prevention and crew protection shall be installed to cover:

- .1 exposed cargo tank domes, any exposed parts of cargo tanks and any part of cargo tank covers that may be exposed to heat from fires in adjacent equipment containing cargo such as exposed booster pumps/heaters/re-gasification or re-liquefaction plants, hereafter addressed as gas process units, positioned on weather decks;

- .2 exposed on-deck storage vessels for flammable or toxic products;
- .3 gas process units positioned on deck;
- .4 cargo liquid and vapour discharge and loading connections, including the presentation flange and the area where their control valves are situated, which shall be at least equal to the area of the drip trays provided;

IACS interpretation (also applicable to 11.4.1, 11.4.3 and 18.10.3.2)

1. *Due to the specifics of liquefied gas bunkering ships, some of these vessels may be provided with additional cargo transfer equipment including transfer loading arms, bunkering booms, transfer hoses, reducers, spool pieces and transfer hoses reels. This additional equipment can be installed in different locations around the ship.*
 2. *When in use, this additional cargo transfer equipment shall comply, where appropriate, with the requirements of paragraphs 11.3.1.4, 11.3.1.5, 11.4.1, 11.4.3 and 18.10.3.2 of the IGC Code for fire detection and fire protection in the cargo area (such as fusible elements, ESD functionality, water spray system protection, dry chemical powder fire-extinguishing systems and drip trays) including hull protection from low temperatures. (IACS UI GC39)*
- .5 all exposed emergency shut-down (ESD) valves in the cargo liquid and vapour pipes, including the master valve for supply to gas consumers;
 - .6 exposed boundaries facing the cargo area, such as bulkheads of superstructures and deckhouses normally manned, cargo machinery spaces, store-rooms containing high fire-risk items and cargo control rooms. Exposed horizontal boundaries of these areas do not require protection unless detachable cargo piping connections are arranged above or below. Boundaries of unmanned forecastle structures not containing high fire-risk items or equipment do not require water-spray protection;
 - .7 exposed lifeboats, liferafts and muster stations facing the cargo area, regardless of distance to cargo area; and

IACS and IMO interpretation

Water spray system

3. *Survival crafts protection*

With reference to sub-paragraph .7 of these Rules (IGC Code) 11.3.1, the survival crafts on board including remote survival crafts (ref. SOLAS III/Reg. 31.1.4) facing the cargo area shall be protected by a water-spray system taking into consideration cargo area extension for fire-fighting purposes as stated in 11.1.4.

Remote liferafts located in areas covered by water-spray protection as required in sub-paragraph .6 may be considered as adequately protected.

(...) (IACS UI GC22, MSC.1/Circ.1606)

- .8 any semi-enclosed cargo machinery spaces and semi-enclosed cargo motor room.

Ships intended for operation as listed in 1.1.10 shall be subject to special consideration (see 11.3.3.2).

11.3.2 Application rates, isolation of damaged sections

11.3.2.1 The system shall be capable of covering all areas mentioned in 11.3.1.1 to 11.3.1.8, with a uniformly distributed water application rate of at least 10 l/m²/min for the largest projected horizontal surfaces and 4 l/m²/min for vertical surfaces. For structures having no clearly defined horizontal or vertical surface, the capacity of the water-spray system shall not be less than the projected horizontal surface multiplied by 10 l/m²/min.

11.3.2.2 On vertical surfaces, spacing of nozzles protecting lower areas may take account of anticipated rundown from higher areas. Stop valves shall be fitted in the main supply line(s) in the water-spray system, at intervals not exceeding 40 m, for the purpose of isolating damaged sections. Alternatively, the system may be divided into two or more sections that may be operated

independently, provided the necessary controls are located together in a readily accessible position outside the cargo area. A section protecting any area included in 11.3.1.1 and .2 shall cover at least the entire athwartship tank grouping in that area. Any gas process unit(s) included in 11.3.1.3 may be served by an independent section.

11.3.3 The capacity of the water-spray pumps shall be capable of simultaneous protection of the greater of the following:

- .1 any two complete athwartship tank groupings, including any gas process units within these areas; or
- .2 for ships intended for operation as listed in 1.1.10, necessary protection subject to special consideration under 11.3.1 of any added fire hazard and the adjacent athwartship tank grouping,

in addition to surfaces specified in 11.3.1.4 to 11.3.1.8. Alternatively, the main fire pumps may be used for this service, provided that their total capacity is increased by the amount needed for the water-spray system. In either case, a connection, through a stop valve, shall be made between the fire main and water-spray system main supply line outside the cargo area.

IACS and IMO interpretation

Water spray system

(...)

4. Tank groups in cargo area

Expression "two complete athwartship tank groupings" in sub-paragraph .1 of these Rules (IGC Code) 11.3.3 means any two groups of tanks where one group is defined as tanks located in transverse direction from ship side to ship side. Where there is only one cargo tank occupying a hold space from ship side to ship side, it will be considered as a "grouping" for the purpose of this interpretation.

"Any two complete athwartship tank groupings" represents an area equal to the combined area of the two largest tank groupings including any gas process units within these areas.

(...) (IACS UI GC22, MSC.1/Circ.1606)

11.3.4 The boundaries of superstructures and deckhouses normally manned, and lifeboats, liferafts and muster areas facing the cargo area, shall also be capable of being served by one of the fire pumps or the emergency fire pump, if a fire in one compartment could disable both fire pumps.

IACS and IMO interpretation

Water spray system

(...)

5. Fire pumps used as spray pumps (*these Rules (IGC Code), Paragraph 11.3.4*):

In cases where the emergency fire pump is used to meet this requirement, its capacity, in addition to being capable of maintaining two jets of water as required by paragraph 12.2.2.1.1 of the FSS Code, shall be increased taking into account the spray application rates stated in paragraph 11.3.2.1, but limiting coverage to boundaries of normally manned superstructures and deckhouses, survival crafts and their muster areas.

For the purpose of this interpretation:

- .1 the expression "one of the fire pumps or emergency fire pump" is related to fire pumps required by SOLAS regulation II-2/10.2.2 installed outside the space where spray pump(s) are located; and
- .2 the expression "fire in one compartment" means a compartment provided with A-class boundaries in which is located the fire pump(s), or the source of power of the fire pump(s), serving the water-spray system in accordance with paragraph 11.3.3. (*IACS UI GC22, MSC.1/Circ.1606*)

Note: See also interpretation in 11.2.2.

11.3.5 Water pumps normally used for other services may be arranged to supply the water-spray system main supply line.

11.3.6 All pipes, valves, nozzles and other fittings in the water-spray system shall be resistant to corrosion by seawater. Piping, fittings and related components within the cargo area (except gaskets) shall be designed to withstand 925°C. The water-spray system shall be arranged with in-line filters to prevent blockage of pipes and nozzles. In addition, means shall be provided to back-flush the system with fresh water.

IMO interpretation

The last sentence of paragraph 11.3.6, i.e. "In addition, means shall be provided to back-flush the system with fresh water", should be understood to mean that arrangements should be provided so that the water-spray system as a whole (i.e. piping, nozzles and in-line filters) can be flushed or back-flushed, as appropriate, with fresh water to prevent the blockage of pipes, nozzles and filters. (MSC.1/Circ.1559)

11.3.7 Remote starting of pumps supplying the water-spray system and remote operation of any normally closed valves in the system shall be arranged in suitable locations outside the cargo area, adjacent to the accommodation spaces and readily accessible and operable in the event of fire in the protected areas.

11.3.8 After installation, the pipes, valves, fittings and assembled system shall be subject to a tightness and function test.

11.4 Dry chemical powder fire-extinguishing systems

11.4.1 Ships in which the carriage of flammable products is intended shall be fitted with fixed dry chemical powder fire-extinguishing systems, approved by the Administration based on the guidelines developed by the Organization¹⁴, for the purpose of firefighting on the deck in the cargo area, including any cargo liquid and vapour discharge and loading connections on deck and bow or stern cargo handling areas, as applicable.

¹⁴ Refer to the *Guidelines for the approval of fixed dry chemical powder fire-extinguishing systems for the protection of ships carrying liquefied gases in bulk* (MSC.1/Circ.1315).

Note:

See interpretation in 11.3.1.4.

11.4.2 The system shall be capable of delivering powder from at least two hand hose lines, or a combination of monitor/hand hose lines, to any part of the exposed cargo liquid and vapour piping, load/unload connection and exposed gas process units.

11.4.3 The dry chemical powder fire-extinguishing system shall be designed with not less than two independent units. Any part required to be protected by 11.4.2 shall be capable of being reached from not less than two independent units with associated controls, pressurizing medium fixed piping, monitors or hand hose lines. For ships with a cargo capacity of less than 1,000 m³, only one such unit need be fitted. A monitor shall be arranged to protect any load/unload connection area and be capable of actuation and discharge both locally and remotely. The monitor is not required to be remotely aimed, if it can deliver the necessary powder to all required areas of coverage from a single position. One hose line shall be provided at both port- and starboard side at the end of the cargo area facing the accommodation and readily available from the accommodation.

Note: See interpretation in 11.3.1.4.

11.4.4 The capacity of a monitor shall be not less than 10 kg/s. Hand hose lines shall be non-kinkable and be fitted with a nozzle capable of on/off operation and discharge at a rate not less than 3.5 kg/s. The maximum discharge rate shall allow operation by one man. The length of a hand hose line shall not exceed 33 m. Where fixed piping is provided between the powder

container and a hand hose line or monitor, the length of piping shall not exceed that length which is capable of maintaining the powder in a fluidized state during sustained or intermittent use, and which can be purged of powder when the system is shut down. Hand hose lines and nozzles shall be of weather-resistant construction or stored in weather resistant housing or covers and be readily accessible.

11.4.5 Hand hose lines shall be considered to have a maximum effective distance of coverage equal to the length of hose. Special consideration shall be given where areas to be protected are substantially higher than the monitor or hand hose reel locations.

11.4.6 Ships fitted with bow/stern load/unload connections shall be provided with independent dry powder unit protecting the cargo liquid and vapour piping, aft or forward of the cargo area, by hose lines and a monitor covering the bow/stern load/unload complying with the requirements of 11.4.1 to 11.4.5.

11.4.7 Ships intended for operation as listed in 1.1.10 shall be subject to special consideration.

11.4.8 After installation, the pipes, valves, fittings and assembled systems shall be subjected to a tightness test and functional testing of the remote and local release stations. The initial testing shall also include a discharge of sufficient amounts of dry chemical powder to verify that the system is in proper working order. All distribution piping shall be blown through with dry air to ensure that the piping is free of obstructions.

IACS and IMO interpretation

Discharge test of dry chemical powder fire-extinguishing systems

Testing arrangements are to involve the discharge using dry chemical powder from all monitors and hand hose lines on board, but it is not required that there is a full discharge of the installed quantity of dry powder. This testing can also be used to satisfy the requirement that the piping is free of obstructions, in lieu of blowing through with dry air all the distribution piping. However, after the completion of this testing, the system, including all monitors and hand hose lines, are to be blown through with dry air; but only for the purpose of the system subsequently being clear from any residues of dry chemical powder. (IACS UI GC31, MSC.1/Circ.1617)

11.5 Enclosed spaces containing cargo handling equipment

11.5.1 Enclosed spaces meeting the criteria of cargo machinery spaces in 1.2.10, and the cargo motor room within the cargo area of any ship, shall be provided with a fixed fire-extinguishing system complying with the provisions of the FSS Code and taking into account the necessary concentrations/application rate required for extinguishing gas fires.

11.5.2 Enclosed spaces meeting the criteria of cargo machinery spaces in Chapter 3.3, within the cargo area of ships that are dedicated to the carriage of a restricted number of cargoes, shall be protected by an appropriate fire-extinguishing system for the cargo carried.

11.5.3 Turret compartments of any ship shall be protected by internal water spray, with an application rate of not less than 10 l/m²/min of the largest projected horizontal surface. If the pressure of the gas flow through the turret exceeds 4 MPa, the application rate shall be increased to 20 l/m²/min. The system shall be designed to protect all internal surfaces.

11.6 Firefighter's outfits

11.6.1 Every ship carrying flammable products shall carry firefighter's outfits complying with the requirements of regulation II-2/10.10 of the SOLAS Convention, as follows:

Total cargo capacity	Number of outfits
5,000 m ³ and below	4
Above 5,000 m ³	5

11.6.2 Additional requirements for safety equipment are given in Chapter 14.

11.6.3 Any breathing apparatus required as part of a firefighter's outfit shall be a self-contained compressed air-operated breathing apparatus having a capacity of at least 1,200 l of free air.

CHAPTER 12

(IGC Code Chapter 12)

Goal

To ensure that arrangements are provided for enclosed spaces in the cargo area to control the accumulation of flammable and/or toxic vapours.

12 ARTIFICIAL VENTILATION IN THE CARGO AREA

Scope

The requirements of this Chapter replace the requirements of SOLAS regulations II-2/4.5.2.6 and 4.5.4.1, as amended.

12.1 Spaces required to be entered during normal cargo handling operations

12.1.1 Electric motor rooms, cargo compressor and pump-rooms, spaces containing cargo handling equipment and other enclosed spaces where cargo vapours may accumulate shall be fitted with fixed artificial ventilation systems capable of being controlled from outside such spaces. The ventilation shall be run continuously to prevent the accumulation of toxic and/or flammable vapours, with a means of monitoring acceptable to the Administration to be provided. A warning notice requiring the use of such ventilation prior to entering shall be placed outside the compartment.

12.1.2 Artificial ventilation inlets and outlets shall be arranged to ensure sufficient air movement through the space to avoid accumulation of flammable, toxic or asphyxiant vapours, and to ensure a safe working environment.

12.1.3 The ventilation system shall have a capacity of not less than 30 changes of air per hour, based upon the total volume of the space. As an exception, non-hazardous cargo control rooms may have eight changes of air per hour.

12.1.4 Where a space has an opening into an adjacent more hazardous space or area, it shall be maintained at an overpressure. It may be made into a less hazardous space or non-hazardous space by overpressure protection in accordance with recognized standards.

12.1.5 Ventilation ducts, air intakes and exhaust outlets serving artificial ventilation systems shall be positioned in accordance with recognized standards ¹⁵.

¹⁵ Refer to the recommendation published by the International Electrotechnical Commission, in particular, to publication IEC 60092-502:1999.

12.1.6 Ventilation ducts serving hazardous areas shall not be led through accommodation, service and machinery spaces or control stations, except as allowed in Chapter 16.

12.1.7 Electric motors' driving fans shall be placed outside the ventilation ducts that may contain flammable vapours. Ventilation fans shall not produce a source of ignition in either the ventilated space or the ventilation system associated with the space. For hazardous areas, ventilation fans and ducts, adjacent to the fans, shall be of non-sparking construction, as defined below:

- .1 impellers or housing of non-metallic construction, with due regard being paid to the elimination of static electricity;
- .2 impellers and housing of non-ferrous materials;
- .3 impellers and housing of austenitic stainless steel; and

.4 ferrous impellers and housing with design tip clearance of not less than 13 mm.

Any combination of an aluminium or magnesium alloy fixed or rotating component and a ferrous fixed or rotating component, regardless of tip clearance, is considered a sparking hazard and shall not be used in these places.

12.1.8 Where fans are required by this Chapter, full required ventilation capacity for each space shall be available after failure of any single fan, or spare parts shall be provided comprising a motor, starter spares and complete rotating element, including bearings of each type.

12.1.9 Protection screens of not more than 13 mm square mesh shall be fitted to outside openings of ventilation ducts.

12.1.10 Where spaces are protected by pressurization, the ventilation shall be designed and installed in accordance with recognized standards ¹⁶.

¹⁶ Refer to the recommendation published by the International Electrotechnical Commission, in particular, to publication IEC 60092-502:1999.

12.2 Spaces not normally entered

12.2.1 Enclosed spaces where cargo vapours may accumulate shall be capable of being ventilated to ensure a safe environment when entry into them is necessary. This shall be capable of being achieved without the need for prior entry.

12.2.2 For permanent installations, the capacity of 8 air changes per hour shall be provided and for portable systems, the capacity of 16 air changes per hour.

12.2.3 Fans or blowers shall be clear of personnel access openings, and shall comply with 12.1.7.

CHAPTER 13
(IGC Code Chapter 13)

Goal

To ensure that the instrumentation and automation systems provides for the safe carriage, handling and conditioning of cargo liquid and vapour.

13 INSTRUMENTATION AND AUTOMATION SYSTEMS

13.1 General

13.1.1 Each cargo tank shall be provided with a means for indicating level, pressure and temperature of the cargo. Pressure gauges and temperature indicating devices shall be installed in the liquid and vapour piping systems, in cargo refrigeration installations.

13.1.2 If loading and unloading of the ship is performed by means of remotely controlled valves and pumps, all controls and indicators associated with a given cargo tank shall be concentrated in one control position.

13.1.3 (...)

13.2 Level indicators for cargo tanks

13.2.1 Each cargo tank shall be fitted with liquid level gauging device(s), arranged to ensure that a level reading is always obtainable whenever the cargo tank is operational. The device(s) shall be designed to operate throughout the design pressure range of the cargo tank and at temperatures within the cargo operating temperature range.

13.2.2 Where only one liquid level gauge is fitted, it shall be arranged so that it can be maintained in an operational condition without the need to empty or gas-free the tank.

IACS and IMO interpretation

Interpretation of paragraph 13.2.2 of the IMO International Code for the Construction and Equipment of Ships Carrying Liquefied Gases in Bulk (Resolution MSC.5(48) as amended by Resolution MSC.370(93))

In order to assess whether or not only one level gauge is acceptable in relation to the aforesaid sentence, the expression "can be maintained" means that any part of the level gauge other than passive parts can be overhauled while the cargo tank is in service.

Note: passive parts are those parts assumed not subject to failures under normal service conditions. (IACS UI GC27, MSC.1/Circ.1625)

13.2.3 Cargo tank liquid level gauges may be of the following types, subject to special requirements for particular cargoes shown in column "g" in the table of Chapter 19:

- .1** indirect devices, which determine the amount of cargo by means such as weighing or in-line flow metering;
- .2** closed devices which do not penetrate the cargo tank, such as devices using radio-isotopes or ultrasonic devices;
- .3** closed devices which penetrate the cargo tank, but which form part of a closed system and keep the cargo from being released, such as float type systems, electronic probes, magnetic probes and bubble tube indicators. If closed gauging device is not mounted directly onto the tank, it shall be provided with a shutoff valve located as close as possible to the tank; and

- .4 restricted devices which penetrate the tank and, when in use, permit a small quantity of cargo vapour or liquid to escape to the atmosphere, such as fixed tube and slip tube gauges. When not in use, the devices shall be kept completely closed. The design and installation shall ensure that no dangerous escape of cargo can take place when opening the device. Such gauging devices shall be so designed that the maximum opening does not exceed 1.5 mm diameter or equivalent area, unless the device is provided with an excess flow valve.

13.3 Overflow control

13.3.1 Except as provided in 13.3.4, each cargo tank shall be fitted with a high liquid level alarm operating independently of other liquid level indicators and giving an audible and visual warning when activated.

13.3.2 An additional sensor operating independently of the high liquid level alarm shall automatically actuate a shutoff valve in a manner that will both avoid excessive liquid pressure in the loading line and prevent the tank from becoming liquid full.

IMO interpretation

The sensor for automatic closing of the loading valve for overflow control as required in paragraph 13.3.2 (13.3.1) may be combined with the liquid level indicators required by paragraph 13.2.1. (MSC/Circ.406/Rev.1)

13.3.3 The emergency shutdown valve referred to in 5.5 and 18.10 may be used for this purpose. If another valve is used for this purpose, the same information as referred to in 18.10.2.1.3 shall be available on board. During loading, whenever the use of these valves may possibly create a potential excess pressure surge in the loading system, alternative arrangements such as limiting the loading rate shall be used.

13.3.4 A high liquid level alarm and automatic shut-off of cargo tank filling need not be required, when the cargo tank:

- .1 is a pressure tank with a volume not more than 200 m³; or
- .2 is designed to withstand the maximum possible pressure during the loading operation, and such pressure is below that of the set pressure of the cargo tank relief valve.

13.3.5 The position of the sensors in the tank shall be capable of being verified before commissioning. At the first occasion of full loading after delivery and after each dry-docking, testing of high-level alarms shall be conducted by raising the cargo liquid level in the cargo tank to the alarm point.

IACS and IMO interpretation

Test for cargo tank's high level alarm

The expression "each dry docking" is considered to be the survey of the outside of the ship's bottom required for the renewal of the Cargo Ship Safety Construction Certificate and or the Cargo Ship Safety Certificate. (IACS UI GC18, MSC.1/Circ.1590)

Note:

IACS Interpretation in 4.20.3.5 also applies to this 13.3.5.

13.3.6 All elements of the level alarms, including the electrical circuit and the sensor(s), of the high, and overflow alarms, shall be capable of being functionally tested. Systems shall be tested prior to cargo operation in accordance with 18.6.2.

13.3.7 Where arrangements are provided for overriding the overflow control system, they shall be such that inadvertent operation is prevented. When this override is operated, continuous visual indication shall be given at the relevant control station(s) and the navigation bridge.

IACS and IMO interpretation

Inhibition of Cargo Pump Operation and Opening of Manifold ESD valves with Level Alarms Overridden

In applying the second sentence of note 4 of table 18.1, a hardware system such as an electric or mechanical interlocking device is to be provided to prevent inadvertent operation of cargo pumps and inadvertent opening of manifold ESD valves. (IACS UI GC35, MSC.1/Circ.1625)

13.4 Pressure monitoring

13.4.1 The vapour space of each cargo tank shall be provided with a direct reading gauge. Additionally, an indirect indication shall be provided at the control position required by 13.1.2. Maximum and minimum allowable pressures shall be clearly indicated.

13.4.2 A high-pressure alarm and, if vacuum protection is required, a low-pressure alarm shall be provided on the navigation bridge and at the control position required by 13.1.2. Alarms shall be activated before the set pressures are reached.

13.4.3 For cargo tanks fitted with PRVs which can be set at more than one set pressure in accordance with 8.2.7, high-pressure alarms shall be provided for each set pressure.

13.4.4 Each cargo-pump discharge line and each liquid and vapour cargo manifold shall be provided with at least one pressure indicator.

13.4.5 Local-reading manifold pressure indication shall be provided to indicate the pressure between ship's manifold valves and hose connections to the shore.

13.4.6 Hold spaces and interbarrier spaces without open connection to the atmosphere shall be provided with pressure indication.

13.4.7 All pressure indications provided shall be capable of indicating throughout the operating pressure range.

13.5 Temperature indicating devices

13.5.1 Each cargo tank shall be provided with at least two devices for indicating cargo temperatures, one placed at the bottom of the cargo tank and the second near the top of the tank, below the highest allowable liquid level. The lowest temperature for which the cargo tank has been designed, as shown on the *International Certificate of Fitness for the Carriage of Liquefied Gases in Bulk* required by 1.4.4, shall be clearly indicated by means of a sign on or near the temperature indicating devices.

13.5.2 The temperature indicating devices shall be capable of providing temperature indication across the expected cargo operating temperature range of the cargo tanks.

13.5.3 Where thermowells are fitted, they shall be designed to minimize failure due to fatigue in normal service.

13.6 Gas detection

13.6.1 Gas detection equipment shall be installed to monitor the integrity of the cargo containment, cargo handling and ancillary systems, in accordance with this section.

13.6.2 A permanently installed system of gas detection and audible and visual alarms shall be fitted in:

- .1 all enclosed cargo and cargo machinery spaces (including turrets compartments) containing gas piping, gas equipment or gas consumers;
- .2 other enclosed or semi-enclosed spaces where cargo vapours may accumulate, including interbarrier spaces and hold spaces for independent tanks other than type C tanks;
- .3 airlocks;
- .4 spaces in gas-fired internal combustion engines, referred to in 16.7.3.3;
- .5 ventilation hoods and gas ducts required by Chapter 16;
- .6 cooling/heating circuits, as required by 7.8.4;
- .7 inert gas generator supply headers; and
- .8 motor rooms for cargo handling machinery.

13.6.3 Gas detection equipment shall be designed, installed and tested in accordance with recognized standards ¹⁷ and shall be suitable for the cargoes to be carried in accordance with column "f" in table of Chapter 19.

¹⁷ IEC 60079-29-1 – Explosive atmospheres – Gas detectors – Performance requirements of detectors for flammable gases.

13.6.4 Where indicated by an "A" in column "f" in the table of Chapter 19 ships certified for carriage of non-flammable products, oxygen deficiency monitoring shall be fitted in cargo machinery spaces and hold spaces for independent tanks other than type C tanks. Furthermore, oxygen deficiency monitoring equipment shall be installed in enclosed or semi-enclosed spaces containing equipment that may cause an oxygen-deficient environment such as nitrogen generators, inert gas generators or nitrogen cycle refrigerant systems.

IACS interpretation

Oxygen Deficiency Monitoring Equipment in a Nitrogen Generator Room Area

Two oxygen sensors are to be positioned at appropriate locations in the space or spaces containing the inert gas system, in accordance with paragraph 15.2.2.4.5.4 of the FSS Code, for all gas carriers, irrespective of the carriage of cargo indicated by an "A" in column "f" in the table in chapter 19 of the Code. (IACS UI GC36)

13.6.5 In the case of toxic products or both toxic and flammable products, except when column "i" in the table of Chapter 19 refers to 17.5.3, portable equipment can be used for the detection of toxic products as an alternative to a permanently installed system. This equipment shall be used prior to personnel entering the spaces listed in 13.6.2 and at 30-minute intervals while they remain in the space.

13.6.6 In the case of gases classified as toxic products, hold spaces and interbarrier spaces shall be provided with a permanently installed piping system for obtaining gas samples from the spaces. Gas from these spaces shall be sampled and analysed from each sampling head location.

13.6.7 Permanently installed gas detection shall be of the continuous detection type, capable of immediate response. Where not used to activate safety shutdown functions required by 13.6.9 and Chapter 16, sampling type detection may be accepted.

13.6.8 When sampling type gas detection equipment is used, the following requirements shall be met:

- .1 the gas detection equipment shall be capable of sampling and analysing for each sampling head location sequentially at intervals not exceeding 30 min;
- .2 individual sampling lines from sampling heads to the detection equipment shall be fitted; and
- .3 pipe runs from sampling heads shall not be led through non-hazardous spaces except as permitted by 13.6.9.

13.6.9 The gas detection equipment may be located in a non-hazardous space, provided that the detection equipment such as sample piping, sample pumps, solenoids and analysing units are located in a fully enclosed steel cabinet with the door sealed by a gasket. The atmosphere within the enclosure shall be continuously monitored. At gas concentrations above 30% lower flammable limit (LFL) inside the enclosure, the gas detection equipment shall be automatically shut down.

13.6.10 Where the enclosure cannot be arranged directly on the forward bulkhead, sample pipes shall be of steel or equivalent material and be routed on their shortest way. Detachable connections, except for the connection points for isolating valves required in 13.6.11 and analysing units, are not permitted.

13.6.11 When gas sampling equipment is located in a non-hazardous space, a flame arrester and a manual isolating valve shall be fitted in each of the gas sampling lines. The isolating valve shall be fitted on the non-hazardous side. Bulkhead penetrations of sample pipes between hazardous and non-hazardous areas shall maintain the integrity of the division penetrated. The exhaust gas shall be discharged to the open air in a safe location.

13.6.12 In every installation, the number and the positions of detection heads shall be determined with due regard to the size and layout of the compartment, the compositions and densities of the products intended to be carried and the dilution from compartment purging or ventilation and stagnant areas.

13.6.13 Any alarms status within a gas detection system required by this section shall initiate an audible and visible alarm:

- .1 on the navigation bridge;
- .2 at the relevant control station(s) where continuous monitoring of the gas levels is recorded; and
- .3 at the gas detector readout location.

13.6.14 In the case of flammable products, the gas detection equipment provided for hold spaces and interbarrier spaces that are required to be inerted shall be capable of measuring gas concentrations of 0% to 100% by volume.

13.6.15 Alarms shall be activated when the vapour concentration by volume reaches the equivalent of 30% LFL in air.

13.6.16 For membrane containment systems, the primary and secondary insulation spaces shall be able to be inerted and their gas content analysed individually ¹⁸. The alarm in the secondary insulation space shall be set in accordance with 13.6.15, that in the primary space is set at a value approved by the Administration or recognized organization acting on its behalf.

¹⁸ *Gas Concentrations in the Insulation Spaces of Membrane LNG Carriers*, March 2007 (published by SIGTTO).

13.6.17 For other spaces described by 13.6.2, alarms shall be activated when the vapour concentration reaches 30% LFL and safety functions required by Chapter 16 shall be activated before the vapour concentration reaches 60% LFL. The crankcases of internal combustion engines that can run on gas shall be arranged to alarm before 100% LFL.

13.6.18 Gas detection equipment shall be so designed that it may readily be tested. (...). Suitable equipment for this purpose shall be carried on board and be used in accordance with the manufacturer's recommendations. Permanent connections for such test equipment shall be fitted.

13.6.19 Every ship shall be provided with at least two sets of portable gas detection equipment that meet the requirement of 13.6.3 or an acceptable national or international standard.

13.6.20 A suitable instrument for the measurement of oxygen levels in inert atmospheres shall be provided.

13.7 Additional requirements for containment systems requiring a secondary barrier

13.7.1 Integrity of barriers

Where a secondary barrier is required, permanently installed instrumentation shall be provided to detect when the primary barrier fails to be liquid-tight at any location or when liquid cargo is in contact with the secondary barrier at any location. This instrumentation shall consist of appropriate gas detecting devices according to 13.6. However, the instrumentation need not be capable of locating the area where liquid cargo leaks through the primary barrier or where liquid cargo is in contact with the secondary barrier.

13.7.2 Temperature indication devices

13.7.2.1 The number and position of temperature-indicating devices shall be appropriate to the design of the containment system and cargo operation requirements.

13.7.2.2 When cargo is carried in a cargo containment system with a secondary barrier, at a temperature lower than -55°C , temperature-indicating devices shall be provided within the insulation or on the hull structure adjacent to cargo containment systems. The devices shall give readings at regular intervals and, where applicable, alarm of temperatures approaching the lowest for which the hull steel is suitable.

13.7.2.3 If cargo is to be carried at temperatures lower than -55°C , the cargo tank boundaries, if appropriate for the design of the cargo containment system, shall be fitted with a sufficient number of temperature-indicating devices to verify that unsatisfactory temperature gradients do not occur.

13.7.2.4 For the purposes of design verification and determining the effectiveness of the initial cooldown procedure on a single or series of similar ships, one tank shall be fitted with devices in excess of those required in 13.7.2.1. These devices may be temporary or permanent and only need to be fitted to the first ship, when a series of similar ships is built.

13.8 Automation systems

13.8.1 The requirements of this section shall apply where automation systems are used to provide instrumented control, monitoring/alarm or safety functions required by these *Rules* (this Code).

13.8.2 Automation systems shall be designed, installed and tested in accordance with recognized standards¹⁹.

¹⁹ Refer to the recommendations for computer-based systems contained in the standard published by the International Electrotechnical Commission, IEC 60092-504:2001 "*Electrical installations in ships – Special features – Control and instrumentation*".

13.8.3 Hardware shall be capable of being demonstrated to be suitable for use in the marine environment by type approval or other means.

13.8.4 Software shall be designed and documented for ease of use, including testing, operation and maintenance.

13.8.5 The user interface shall be designed such that the equipment under control can be operated in a safe and effective manner at all times.

13.8.6 Automation systems shall be arranged such that a hardware failure or an error by the operator does not lead to an unsafe condition. Adequate safeguards against incorrect operation shall be provided.

13.8.7 Appropriate segregation shall be maintained between control, monitoring/alarm and safety functions to limit the effect of single failures. This shall be taken to include all parts of the automation systems that are required to provide specified functions, including connected devices and power supplies.

13.8.8 Automation systems shall be arranged such that the software configuration and parameters are protected against unauthorized or unintended change.

13.8.9 A management of change process shall be applied to safeguard against unexpected consequences of modification. Records of configuration changes and approvals shall be maintained on board.

13.8.10 Processes for the development and maintenance of integrated systems shall be in accordance with recognized standards²⁰. These processes shall include appropriate risk identification and management.

²⁰ Refer to the International Electrotechnical Commission standard ISO/IEC 15288:2008 *Systems and software engineering – System life cycle processes*, and ISO 17894:2005 *Ships and marine technology – Computer applications – General principles for the development and use of programmable electronic systems in marine applications*.

13.9 System integration

13.9.1 Essential safety functions shall be designed such that risks of harm to personnel or damage to the installation or the environment are reduced to a level acceptable to the Administration, both in normal operation and under fault conditions. Functions shall be designed to fail-safe. Roles and responsibilities for integration of systems shall be clearly defined and agreed by relevant parties.

13.9.2 Functional requirements of each component subsystem shall be clearly defined to ensure that the integrated system meets the functional and specified safety requirements and takes account of any limitations of the equipment under control.

13.9.3 Key hazards of the integrated system shall be identified using appropriate risk-based techniques.

IACS and IMO interpretation

Integrated systems

The expression “integrated system” means a combination of computer-based systems which are used for the control, monitoring/alarm and safety functions required for the carriage, handling and conditioning of cargo liquid and vapours and are interconnected in order to allow communication between computer-based systems and to allow centralized access to monitoring/alarm and safety information and/or command/control.

Referenced Guidelines

MSC/Circ.891 – Guidelines for the On-board Use and Application of Computers

2.1 Computer



A programmable electronic device for storing and processing data, making calculations, or any programmable electronic system (PES), including main-frame, mini-computer or microcomputer.

2.2 Computer-based system

A system of one or more computers, associated software, peripherals and interfaces.

2.3 Integrated system

A combination of computer-based systems which are interconnected in order to allow centralized access to sensor information and/or command/control.

The expression "each dry docking" is considered to be the survey of the outside of the ship's bottom required for the renewal of the Cargo Ship Safety Construction Certificate and or the Cargo Ship Safety Certificate. (IACS UI GC29, MSC.1/Circ.1625)

13.9.4 The integrated system shall have a suitable means of reversionary control.

13.9.5 Failure of one part of the integrated system shall not affect the functionality of other parts, except for those functions directly dependent on the defective part.

13.9.6 Operation with an integrated system shall be at least as effective as it would be with individual stand-alone equipment or systems.

13.9.7 The integrity of essential machinery or systems, during normal operation and fault conditions, shall be demonstrated.

CHAPTER 14
(IGC Code Chapter 14)

Goal

To ensure that protective equipment is provided for ship staff, considering both routine operations or emergency situations and possible short- or long-term effects of the product being handled.

14 PERSONNEL PROTECTION

14.1 Protective equipment

14.1.1 Suitable protective equipment, including eye protection to a recognized national or international standard, shall be provided for protection of crew members engaged in normal cargo operations, taking into account the characteristics of the products being carried.

14.1.2 Personal protective and safety equipment required in this Chapter shall be kept in suitable, clearly marked lockers located in readily accessible places.

14.1.3 The compressed air equipment shall be inspected at least once a month by a responsible officer and the inspection logged in the ship's records. This equipment shall also be inspected and tested by a competent person at least once a year.

14.2 First-aid equipment

14.2.1 A stretcher that is suitable for hoisting an injured person from spaces below deck shall be kept in a readily accessible location.

14.2.2 The ship shall have onboard medical first-aid equipment, including oxygen resuscitation equipment, based on the requirements of the Medical First Aid Guide (MFAG) for the cargoes listed on the *International Certificate of Fitness for the Carriage of Liquefied Gases in Bulk* shown in Appendix 2.

14.3 Safety equipment

14.3.1 Sufficient, but not less than three complete sets of safety equipment shall be provided in addition to the firefighter's outfits required by 11.6.1. Each set shall provide adequate personal protection to permit entry and work in a gas-filled space. This equipment shall take into account the nature of the cargoes, listed on the *International Certificate of Fitness for the Carriage of Liquefied Gases in Bulk* shown in Appendix 2.

14.3.2 Each complete set of safety equipment shall consist of:

- .1 one self-contained positive pressure air-breathing apparatus incorporating full face mask, not using stored oxygen and having a capacity of at least 1,200 l of free air. Each set shall be compatible with that required by 11.6.1;
- .2 protective clothing, boots and gloves to a recognized standard;
- .3 steel-cored rescue line with belt; and
- .4 explosion-proof lamp.

14.3.3 An adequate supply of compressed air shall be provided and shall consist of:

- .1 at least one fully charged spare air bottle for each breathing apparatus required by 14.3.1;
- .2 an air compressor of adequate capacity capable of continuous operation, suitable for the supply of high-pressure air of breathable quality; and

- .3 a charging manifold capable of dealing with sufficient spare breathing apparatus air bottles for the breathing apparatus required by 14.3.1.

14.4 Personal protection requirements for individual products

14.4.1 Requirements of this section shall apply to ships carrying products for which those paragraphs are listed in column "i" in the table of Chapter 19.

14.4.2 Suitable respiratory and eye protection for emergency escape purposes shall be provided for every person on board, subject to the following:

- .1 filter-type respiratory protection is unacceptable;
- .2 self-contained breathing apparatus shall have at least a duration of service of 15 min; and
- .3 emergency escape respiratory protection shall not be used for firefighting or cargo-handling purposes and shall be marked to that effect.

14.4.3 One or more suitably marked decontamination showers and eyewash stations shall be available on deck, taking into account the size and layout of the ship. The showers and eyewashes shall be operable in all ambient conditions.

14.4.4 The protective clothing required under 14.3.2.2 shall be gastight.

CHAPTER 15
(IGC Code Chapter 15)

Goal

To determine the maximum quantity of cargo that can be loaded.

15 FILLING LIMITS FOR CARGO TANKS

15.1 Definitions

15.1.1 Filling limit (FL) means the maximum liquid volume in a cargo tank relative to the total tank volume when the liquid cargo has reached the reference temperature.

15.1.2 Loading limit (LL) means the maximum allowable liquid volume relative to the tank volume to which the tank may be loaded.

15.1.3 Reference temperature means (for the purposes of this Chapter only):

- .1 when no cargo vapour pressure/temperature control, as referred to in Chapter 7, is provided, the temperature corresponding to the vapour pressure of the cargo at the set pressure of the PRVs; and
- .2 when a cargo vapour pressure/temperature control, as referred to in Chapter 7, is provided, the temperature of the cargo upon termination of loading, during transport or at unloading, whichever is the greatest.

15.1.4 Ambient design temperature for unrestricted service means sea temperature of 32°C and air temperature of 45°C. However, lesser values of these temperatures may be accepted by the Administration for ships operating in restricted areas or on voyages of restricted duration, and account may be taken in such cases of any insulation of the tanks. Conversely, higher values of these temperatures may be required for ships permanently operating in areas of high-ambient temperature.

15.2 General requirements

The maximum filling limit of cargo tanks shall be so determined that the vapour space has a minimum volume at reference temperature allowing for:

- .1 tolerance of instrumentation such as level and temperature gauges;
- .2 volumetric expansion of the cargo between the PRV set pressure and the maximum allowable rise stated in 8.4; and
- .3 an operational margin to account for liquid drained back to cargo tanks after completion of loading, operator reaction time and closing time of valves, see 5.5 and 18.10.2.1.4.

15.3 Default filling limit

The default value for the filling limit (FL) of cargo tanks is 98% at the reference temperature. Exceptions to this value shall meet the requirements of 15.4.

15.4 Determination of increased filling limit

15.4.1 A filling limit greater than the limit of 98% specified in 15.3 may be permitted under the trim and list conditions specified in 8.2.17, providing:

- .1 no isolated vapour pockets are created within the cargo tank;
- .2 the PRV inlet arrangement shall remain in the vapour space; and
- .3 allowances need to be provided for:

- .1 volumetric expansion of the liquid cargo due to the pressure increase from the MARVS to full flow relieving pressure in accordance with 8.4.1;
- .2 an operational margin of minimum 0.1% of tank volume; and
- .3 tolerances of instrumentation such as level and temperature gauges.

15.4.2 In no case shall a filling limit exceeding 99.5% at reference temperature be permitted.

15.5 Maximum loading limit

15.5.1 The maximum loading limit (*LL*) to which a cargo tank may be loaded shall be determined by the following formula:

$$LL = FL \frac{\rho_R}{\rho_L}$$

where:

- LL* = loading limit as defined in 15.1.2, expressed in percentage;
FL = filling limit as specified in 15.3 or 15.4 expressed in percentage;
 ρ_R = relative density of cargo at the reference temperature; and
 ρ_L = relative density of cargo at the loading temperature.

15.5.2 The Administration may allow type C tanks to be loaded according to the formula in 15.5.1 with the relative density ρ_R as defined below, provided that the tank vent system has been approved in accordance with 8.2.18:

- ρ_R = relative density of cargo at the highest temperature that the cargo may reach upon termination of loading, during transport, or at unloading, under the ambient design temperature conditions described in 15.1.4.

This paragraph does not apply to products requiring a type 1G ship.

15.6 Information to be provided to the master

15.6.1 A document shall be provided to the ship, specifying the maximum allowable loading limits for each cargo tank and product, at each applicable loading temperature and maximum reference temperature. The information in this document shall be approved by the Administration or recognized organization acting on its behalf.

15.6.2 Pressures at which the PRVs have been set shall also be stated in the document.

15.6.3 A copy of the above document shall be permanently kept on board by the master.

CHAPTER 16
(IGC Code Chapter 16)

Goal

To ensure the safe use of cargo as fuel.

16 USE OF CARGO AS FUEL

16.1 General

Except as provided for in 16.9, methane (LNG) is the only cargo whose vapour or boil-off gas may be utilized in machinery spaces of category A, and, in these spaces, it may be utilized only in systems such as boilers, inert gas generators, internal combustion engines, gas combustion unit and gas turbines.

16.2 Use of cargo vapour as fuel

This section addresses the use of cargo vapour as fuel in systems such as boilers, inert gas generators, internal combustion engines, gas combustion units and gas turbines.

16.2.1 For vaporized LNG, the fuel supply system shall comply with the requirements of 16.4.1, 16.4.2 and 16.4.3.

16.2.2 For vaporized LNG, gas consumers shall exhibit no visible flame and shall maintain the uptake exhaust temperature below 535°C.

16.3 Arrangement of spaces containing gas consumers

16.3.1 Spaces in which gas consumers are located shall be fitted with a mechanical ventilation system that is arranged to avoid areas where gas may accumulate, taking into account the density of the vapour and potential ignition sources. The ventilation system shall be separated from those serving other spaces.

16.3.2 Gas detectors shall be fitted in these spaces, particularly where air circulation is reduced. The gas detection system shall comply with the requirements of Chapter 13.

16.3.3 Electrical equipment located in the double wall pipe or duct specified in 16.4.3 shall comply with the requirements of Chapter 10.

16.3.4 All vents and bleed lines that may contain or be contaminated by gas fuel shall be routed to a safe location external to the machinery space and be fitted with a flame screen.

16.4 Gas fuel supply

16.4.1 General

16.4.1.1 The requirements of this section shall apply to gas fuel supply piping outside of the cargo area. Fuel piping shall not pass through accommodation spaces, service spaces, electrical equipment rooms or control stations. The routing of the pipeline shall take into account potential hazards, due to mechanical damage, in areas such as stores or machinery handling areas.

16.4.1.2 Provision shall be made for inerting and gas-freeing that portion of the gas fuel piping systems located in the machinery space.

16.4.2 Leak detection

Continuous monitoring and alarms shall be provided to indicate a leak in the piping system in enclosed spaces and shut down the relevant gas fuel supply.

16.4.3 Routing of fuel supply pipes

Fuel piping may pass through or extend into enclosed spaces other than those mentioned in 16.4.1, provided it fulfils one of the following conditions:

- .1 it is of a double-wall design with the space between the concentric pipes pressurized with inert gas at a pressure greater than the gas fuel pressure. The master gas fuel valve, as required by 16.4.6, closes automatically upon loss of inert gas pressure; or
- .2 it is installed in a pipe or duct equipped with mechanical exhaust ventilation having a capacity of at least 30 air changes per hour and is arranged to maintain a pressure less than the atmospheric pressure. The mechanical ventilation is in accordance with Chapter 12, as applicable. The ventilation is always in operation when there is fuel in the piping and the master gas fuel valve, as required by 16.4.6, closes automatically if the required air flow is not established and maintained by the exhaust ventilation system. The inlet or the duct may be from a non-hazardous machinery space, and the ventilation outlet is in a safe location.

16.4.4 Requirements for gas fuel with pressure greater than 1 MPa

16.4.4.1 Fuel delivery lines between the high-pressure fuel pumps/compressors and consumers shall be protected with a double-walled piping system capable of containing a high pressure line failure, taking into account the effects of both pressure and low temperature. A single-walled pipe in the cargo area up to the isolating valve(s) required by 16.4.6 is acceptable.

16.4.4.2 The arrangement in 16.4.3.2 may also be acceptable providing the pipe or trunk is capable of containing a high pressure line failure, according to the requirements of 16.4.7 and taking into account the effects of both pressure and possible low temperature and providing both inlet and exhaust of the outer pipe or trunk are in the cargo area.

16.4.5 Gas consumer isolation

The supply piping of each gas consumer unit shall be provided with gas fuel isolation by automatic double block and bleed, vented to a safe location, under both normal and emergency operation. The automatic valves shall be arranged to fail to the closed position on loss of actuating power. In a space containing multiple consumers, the shutdown of one shall not affect the gas supply to the others.

16.4.6 Spaces containing gas consumers

16.4.6.1 It shall be possible to isolate the gas fuel supply to each individual space containing a gas consumer(s) or through which fuel gas supply piping is run, with an individual master valve, which is located within the cargo area. The isolation of gas fuel supply to a space shall not affect the gas supply to other spaces containing gas consumers if they are located in two or more spaces, and it shall not cause loss of propulsion or electrical power.

16.4.6.2 If the double barrier around the gas supply system is not continuous due to air inlets or other openings, or if there is any point where single failure will cause leakage into the space, the individual master valve for the space shall operate under the following circumstances:

- .1 automatically by:
 - .1 gas detection within the space;

- .2 leak detection in the annular space of a double-walled pipe;
 - .3 leak detection in other compartments inside the space, containing single-walled gas piping;
 - .4 loss of ventilation in the annular space of a double-walled pipe; and
 - .5 loss of ventilation in other compartments inside the space, containing single-walled gas piping; and
- .2 manually from within the space, and at least one remote location.

16.4.6.3 If the double barrier around the gas supply system is continuous, an individual master valve located in the cargo area may be provided for each gas consumer inside the space. The individual master valve shall operate under the following circumstances:

- .1 automatically by:
 - .1 leak detection in the annular space of a double-walled pipe served by that individual master valve;
 - .2 leak detection in other compartments containing single-walled gas piping that is part of the supply system served by the individual master valve; and
 - .3 loss of ventilation or loss of pressure in the annular space of a double-walled pipe; and
- .2 manually from within the space, and at least one remote location.

16.4.7 Piping and ducting construction

Gas fuel piping in machinery spaces shall comply with 5.1 to 5.9, as applicable. The piping shall, as far as practicable, have welded joints. Those parts of the gas fuel piping that are not enclosed in a ventilated pipe or duct according to 16.4.3, and are on the weather decks outside the cargo area, shall have full penetration butt-welded joints and shall be fully radiographed.

16.4.8 Gas detection

Gas detection systems provided in accordance with the requirements of this Chapter shall activate the alarm at 30% LFL and shut down the master gas fuel valve required by 16.4.6 at not more than 60% LFL (see 13.6.17).

16.5 Gas fuel plant and related storage tanks

16.5.1 Provision of gas fuel

All equipment (heaters, compressors, vaporizers, filters, etc.) for conditioning the cargo and/or cargo boil off vapour for its use as fuel, and any related storage tanks, shall be located in the cargo area. If the equipment is in an enclosed space, the space shall be ventilated according to 12.1 and be equipped with a fixed fire-extinguishing system, according to 11.5, and with a gas detection system according to 13.6, as applicable.

16.5.2 Remote stops

16.5.2.1 All rotating equipment utilized for conditioning the cargo for its use as fuel shall be arranged for manual remote stop from the engine-room. Additional remote stops shall be located in areas that are always easily accessible, typically cargo control room, navigation bridge and fire control station.

16.5.2.2 The fuel supply equipment shall be automatically stopped in the case of low suction pressure or fire detection. Unless expressly provided otherwise, the requirements of 18.10 need not apply to gas fuel compressors or pumps when used to supply gas consumers.

16.5.3 Heating and cooling mediums

If the heating or cooling medium for the gas fuel conditioning system is returned to spaces outside the cargo area, provisions shall be made to detect and alarm the presence of cargo/cargo vapour in the medium. Any vent outlet shall be in a safe position and fitted with an effective flame screen of an approved type.

16.5.4 Piping and pressure vessels

Piping or pressure vessels fitted in the gas fuel supply system shall comply with Chapter 5.

16.6 Special requirements for main boilers

16.6.1 Arrangements

16.6.1.1 Each boiler shall have a separate exhaust uptake.

16.6.1.2 Each boiler shall have a dedicated forced draught system. A crossover between boiler force draught systems may be fitted for emergency use providing that any relevant safety functions are maintained.

16.6.1.3 Combustion chambers and uptakes of boilers shall be designed to prevent any accumulation of gaseous fuel.

16.6.2 Combustion equipment

16.6.2.1 The burner systems shall be of dual type, suitable to burn either: oil fuel or gas fuel alone, or oil and gas fuel simultaneously.

16.6.2.2 Burners shall be designed to maintain stable combustion under all firing conditions.

16.6.2.3 An automatic system shall be fitted to change over from gas fuel operation to oil fuel operation without interruption of the boiler firing, in the event of loss of gas fuel supply.

16.6.2.4 Gas nozzles and the burner control system shall be configured such that gas fuel can only be ignited by an established oil fuel flame, unless the boiler and combustion equipment is designed and approved by recognized organization to light on gas fuel.

16.6.3 Safety

16.6.3.1 There shall be arrangements to ensure that gas fuel flow to the burner is automatically cut-off, unless satisfactory ignition has been established and maintained.

16.6.3.2 On the pipe of each gas-burner, a manually operated shut-off valve shall be fitted.

16.6.3.3 Provisions shall be made for automatically purging the gas supply piping to the burners, by means of an inert gas, after the extinguishing of these burners.

16.6.3.4 The automatic fuel changeover system required by 16.6.2.3 shall be monitored with alarms to ensure continuous availability.

16.6.3.5 Arrangements shall be made that, in case of flame failure of all operating burners, the combustion chambers of the boilers are automatically purged before relighting.

16.6.3.6 Arrangements shall be made to enable the boilers to be manually purged.

16.7 Special requirements for gas-fired internal combustion engines

Dual fuel engines are those that employ gas fuel (with pilot oil) and oil fuel. Oil fuels may include distillate and residual fuels. Gas only engines are those that employ gas fuel only.

16.7.1 Arrangements

16.7.1.1 When gas is supplied in a mixture with air through a common manifold, flame arrestors shall be installed before each cylinder head.

16.7.1.2 Each engine shall have its own separate exhaust.

16.7.1.3 The exhausts shall be configured to prevent any accumulation of unburnt gaseous fuel.

16.7.1.4 Unless designed with the strength to withstand the worst case overpressure due to ignited gas leaks, air inlet manifolds, scavenge spaces, exhaust system and crank cases shall be fitted with suitable pressure relief systems. Pressure relief systems shall lead to a safe location, away from personnel.

IACS and IMO interpretation

Suitable Pressure Relief System for Air Inlet, Scavenge Spaces, Exhaust System and Crank Case

A suitable pressure relief system for air inlet manifolds, scavenge spaces and exhaust system is to be provided unless designed to accommodate the worst-case overpressure due to ignited gas leaks or justified by the safety concept of the engine. A detailed evaluation regarding the hazard potential of overpressure in air inlet manifolds, scavenge spaces and exhaust system is to be carried out and reflected in the safety concept of the engine.

In the case of crankcases, the explosion relief valves, as required by Regulation 27.4 of SOLAS Chapter II-1 as amended by IMO resolutions up to MSC.436(99), are to be considered suitable for the gas operation of the engine. For engines not covered by said Regulation, a detailed evaluation regarding the hazard potential of fuel gas accumulation in the crankcase is to be carried out. (IACS UI GC37, MSC.1/Circ.1625)

16.7.1.5 Each engine shall be fitted with vent systems independent of other engines for crankcases, sumps and cooling systems.

16.7.2 Combustion equipment

16.7.2.1 Prior to admission of gas fuel, correct operation of the pilot oil injection system on each unit shall be verified.

16.7.2.2 For a spark ignition engine, if ignition has not been detected by the engine monitoring system within an engine specific time after opening of the gas supply valve, this shall be automatically shut off and the starting sequence terminated. It shall be ensured that any unburnt gas mixture is purged from the exhaust system.

16.7.2.3 For dual-fuel engines fitted with a pilot oil injection system, an automatic system shall be fitted to change over from gas fuel operation to oil fuel operation with minimum fluctuation of the engine power.

16.7.2.4 In the case of unstable operation on engines with the arrangement in 16.7.2.3 when gas firing, the engine shall automatically change to oil fuel mode.

16.7.3 Safety

16.7.3.1 During stopping of the engine, the gas fuel shall be automatically shut off before the ignition source.

16.7.3.2 Arrangements shall be provided to ensure that there is no unburnt gas fuel in the exhaust gas system prior to ignition.

16.7.3.3 Crankcases, sumps, scavenge spaces and cooling system vents shall be provided with gas detection (see 13.6.17).

16.7.3.4 Provision shall be made within the design of the engine to permit continuous monitoring of possible sources of ignition within the crank case. Instrumentation fitted inside the crankcase shall be in accordance with the requirements of Chapter 10.

16.7.3.5 A means shall be provided to monitor and detect poor combustion or misfiring that may lead to unburnt gas fuel in the exhaust system during operation. In the event that it is detected, the gas fuel supply shall be shut down. Instrumentation fitted inside the exhaust system shall be in accordance with the requirements of Chapter 10.

16.8 Special requirements for gas turbine

16.8.1 Arrangements

16.8.1.1 Each turbine shall have its own separate exhaust.

16.8.1.2 The exhausts shall be appropriately configured to prevent any accumulation of unburnt gas fuel.

16.8.1.3 Unless designed with the strength to withstand the worst case overpressure due to ignited gas leaks, pressure relief systems shall be suitably designed and fitted to the exhaust system, taking into consideration explosions due to gas leaks. Pressure relief systems within the exhaust uptakes shall be lead to a non-hazardous location, away from personnel.

16.8.2 Combustion equipment

An automatic system shall be fitted to change over easily and quickly from gas fuel operation to oil fuel operation with minimum fluctuation of the engine power.

16.8.3 Safety

16.8.3.1 Means shall be provided to monitor and detect poor combustion that may lead to unburnt gas fuel in the exhaust system during operation. In the event that it is detected, the gas fuel supply shall be shut down.

16.8.3.2 Each turbine shall be fitted with an automatic shutdown device for high exhaust temperatures.

16.9 Alternative fuels and technologies

16.9.1 If acceptable to the Administration, other cargo gases may be used as fuel, providing that the same level of safety as natural gas in these *Rules* (this Code) is ensured.

16.9.2 The use of cargoes requiring carriage in type 1G ships, as identified in column "c" in the table of Chapter 19, shall not be permitted. If acceptable to the Administration, cargoes identified as toxic products in column "f" which are required to be carried in type 2G/2PG ships in column "c" in the table of Chapter 19 may be used as fuel, provided that the same level of safety as natural gas (methane) is ensured in accordance with the relevant provisions of this Code, including those in 1.3, and taking into account the guidelines developed by the Organization *, after special consideration has been given by the Administration."

* Refer to the guidelines to be developed by the Organization.

16.9.3 For cargoes other than LNG, the fuel supply system shall comply with the requirements of 16.4.1, 16.4.2, 16.4.3 and 16.5, as applicable, and shall include means for preventing condensation of vapour in the system.

16.9.4 Liquefied gas fuel supply systems shall comply with 16.4.5.

16.9.5 In addition to the requirements of 16.4.3.2, both ventilation inlet and outlet shall be located outside the machinery space. The inlet shall be in a non-hazardous area and the outlet shall be in a safe location.

CHAPTER 17

(IGC Code Chapter 17)

Goal

To set out the additional requirements in respect of specific cargoes.

17 SPECIAL REQUIREMENTS**17.1 General**

The requirements of this Chapter are applicable where reference thereto is made in column "i" in the table of Chapter 19. These requirements are additional to the general requirements of these *Rules* (the Code).

17.2 Materials of construction

Materials that may be exposed to cargo during normal operations shall be resistant to the corrosive action of the gases. In addition, the following materials of construction for cargo tanks and associated pipelines, valves, fittings and other items of equipment normally in direct contact with the cargo liquid or vapour shall not be used for certain products as specified in column "i" in the table of Chapter 19:

- .1 mercury, copper and copper-bearing alloys, and zinc;
- .2 copper, silver, mercury, magnesium and other acetylide-forming metals;
- .3 aluminium and aluminium-bearing alloys;
- .4 copper, copper alloys, zinc and galvanized steel;
- .5 aluminium, copper and alloys of either; and
- .6 copper and copper-bearing alloys with greater than 1% copper.

17.3 Independent tanks

17.3.1 Products shall be carried in independent tanks only.

17.3.2 Products shall be carried in type C independent tanks, and the requirements of 7.1.2 shall apply. The design pressure of the cargo tank shall take into account any padding pressure or vapour discharge unloading pressure.

17.4 Refrigeration systems

17.4.1 Only the indirect system described in 7.3.1.2 shall be used.

17.4.2 For a ship engaged in the carriage of products that readily form dangerous peroxides, recondensed cargo shall not be allowed to form stagnant pockets of uninhibited liquid. This may be achieved either by:

- .1 using the indirect system described in 7.3.1.2, with the condenser inside the cargo tank;
or
- .2 using the direct system or combined system described in 7.3.1.1 and .3 respectively, or the indirect system described in 7.3.1.2 with the condenser outside the cargo tank, and designing the condensate system to avoid any places in which liquid could collect and be retained. Where this is impossible, inhibited liquid shall be added upstream of such a place.

17.4.3 (...)

17.5 Cargoes requiring type 1G ship

17.5.1 All butt-welded joints in cargo piping exceeding 75 mm in diameter shall be subject to 100% radiography.

17.5.2 Gas sampling lines shall not be led into or through non-hazardous areas. Alarms referred to in 13.6.2 shall be activated when the vapour concentration reaches the threshold limiting value.

17.5.3 The alternative of using portable gas detection equipment in accordance with 13.6.5 shall not be permitted.

17.5.4 Cargo control rooms shall be located in a non-hazardous area and, additionally, all instrumentation shall be of the indirect type.

17.5.5 Personnel shall be protected against the effects of a major cargo release by the provision of a space within the accommodation area that is designed and equipped to the satisfaction of the Administration.

17.5.6 Notwithstanding the requirements in 3.2.4.3, access to forecastle spaces shall not be permitted through a door facing the cargo area, unless airlock in accordance with 3.6 is provided.

17.5.7 Notwithstanding the requirements in 3.2.7, access to control rooms and machinery spaces of turret systems shall not be permitted through doors facing the cargo area.

17.6 Exclusion of air from vapour spaces

Air shall be removed from cargo tanks and associated piping before loading and, then, subsequently excluded by:

- .1 introducing inert gas to maintain a positive pressure. Storage or production capacity of the inert gas shall be sufficient to meet normal operating requirements and relief valve leakage. The oxygen content of inert gas shall, at no time, be greater than 0.2% by volume; or
- .2 control of cargo temperatures such that a positive pressure is maintained at all times.

17.7 Moisture control

For gases that are non-flammable and may become corrosive or react dangerously with water, moisture control shall be provided to ensure that cargo tanks are dry before loading and that, during discharge, dry air or cargo vapour is introduced to prevent negative pressures. For the purposes of this paragraph, dry air is air that has a dew point of -45°C or below at atmospheric pressure.

17.8 Inhibition

(...)

17.9 Flame screens on vent outlets

When carrying a cargo referenced to this section, cargo tank vent outlets shall be provided with readily renewable and effective flame screens or safety heads of an approved type. Due attention shall be paid in the design of flame screens and vent heads, to the possibility of the blockage of these devices by the freezing of cargo vapour or by icing up in adverse weather conditions. Flame screens shall be removed and replaced by protection screens, in accordance with 8.2.15, when carrying cargoes not referenced to this section.

17.10 Maximum allowable quantity of cargo per tank

(...)

17.11 Cargo pumps and discharge arrangements

17.11.1 (...)

17.11.2 The cargo shall be discharged only by deepwell pumps or by hydraulically operated submerged pumps. These pumps shall be of a type designed to avoid liquid pressure against the shaft gland.

17.11.3 Inert gas displacement may be used for discharging cargo from type C independent tanks, provided the cargo system is designed for the expected pressure.

17.12 Ammonia

17.12.1 Anhydrous ammonia may cause stress corrosion cracking in containment and process systems made of carbon-manganese steel or nickel steel. To minimize the risk of this occurring, measures detailed in 17.12.2 to 17.12.8 shall be taken, as appropriate.

17.12.2 Where carbon-manganese steel is used, cargo tanks, process pressure vessels and cargo piping shall be made of fine-grained steel with a specified minimum yield strength not exceeding 355 N/mm², and with an actual yield strength not exceeding 440 N/mm². One of the following constructional or operational measures shall also be taken:

- .1 lower strength material with a specified minimum tensile strength not exceeding 410 N/mm² shall be used; or
- .2 cargo tanks, etc., shall be post-weld stress relief heat treated; or
- .3 carriage temperature shall be maintained, preferably at a temperature close to the product's boiling point of -33°C, but in no case at a temperature above -20°C; or
- .4 the ammonia shall contain not less than 0.1% w/w water, and the master shall be provided with documentation confirming this.

17.12.3 If carbon-manganese steels with higher yield properties are used other than those specified in 17.12.2, the completed cargo tanks, piping, etc., shall be given a post-weld stress relief heat treatment.

17.12.4 Process pressure vessels and piping of the condensate part of the refrigeration system shall be given a post-weld stress relief heat treatment when made of materials mentioned in 17.12.1.

17.12.5 The tensile and yield properties of the welding consumables shall exceed those of the tank or piping material by the smallest practical amount.

17.12.6 Nickel steel containing more than 5% nickel and carbon-manganese steel, not complying with the requirements of 17.12.2 and 17.12.3, are particularly susceptible to ammonia stress corrosion cracking and shall not be used in containment and piping systems for the carriage of this product.

17.12.7 Nickel steel containing not more than 5% nickel may be used, provided the carriage temperature complies with the requirements specified in 17.12.2.3.

17.12.8 (...)

17.13 Chlorine

17.13.1 *Cargo containment system*

17.13.1.1 The capacity of each tank shall not exceed 600 m³ and the total capacity of all cargo tanks shall not exceed 1,200 m³.

17.13.1.2 The tank design vapour pressure shall not be less than 1.35 MPa (see 7.1.2 and 17.3.2).

17.13.1.3 Parts of tanks protruding above the upper deck shall be provided with protection against thermal radiation, taking into account total engulfment by fire.

17.13.1.4 Each tank shall be provided with two PRVs. A bursting disc of appropriate material shall be installed between the tank and the PRVs. The rupture pressure of the bursting disc shall be 0.1 MPa lower than the opening pressure of the pressure relief valve, which shall be set at the design vapour pressure of the tank but not less than 1.35 MPa gauge. The space between the bursting disc and the relief valve shall be connected through an excess flow valve to a pressure gauge and a gas detection system. Provisions shall be made to keep this space at or near the atmospheric pressure during normal operation.

17.13.1.5 Outlets from PRVs shall be arranged in such a way as to minimize the hazards on board the ship as well as to the environment. Leakage from the relief valves shall be led through the absorption plant to reduce the gas concentration as far as possible. The relief valve exhaust line shall be arranged at the forward end of the ship to discharge outboard at deck level with an arrangement to select either port or starboard side, with a mechanical interlock to ensure that one line is always open.

17.13.1.6 (...)

17.13.2 *Cargo piping systems*

17.13.2.1 (...)

17.13.2.2 The design pressure of the cargo piping system shall be not less than 2.1 MPa gauge. The internal diameter of the cargo pipes shall not exceed 100 mm. Only pipe bends shall be accepted for compensation of pipeline thermal movement. The use of flanged joints shall be restricted to a minimum and, when used, the flanges shall be of the welding neck type with tongue and groove.

17.13.2.3 Relief valves of the cargo piping system shall discharge to the absorption plant, and the flow restriction created by this unit shall be taken into account when designing the relief valve system (see 8.4.3 and 8.4.4).

17.13.3 *Materials*

17.13.3.1 The cargo tanks and cargo piping systems shall be made of steel suitable for the cargo and for a temperature of -40°C, even if a higher transport temperature is intended to be used.

17.13.3.2 The tanks shall be thermally stress relieved. Mechanical stress relief shall not be accepted as an equivalent.

17.13.4 Instrumentation: safety devices

17.13.4.1 The ship shall be provided with a chlorine absorbing plant with a connection to the cargo piping system and the cargo tanks. The absorbing plant shall be capable of neutralizing at least 2% of the total cargo capacity at a reasonable absorption rate.

17.13.4.2 (...)

17.13.4.3 A gas detecting system shall be provided that is capable of monitoring chlorine concentrations of at least 1 ppm by volume. Sample points shall be located:

- .1 near the bottom of the hold spaces;
- .2 in the pipes from the safety relief valves;
- .3 at the outlet from the gas absorbing plant;
- .4 at the inlet to the ventilation systems for the accommodation, service and machinery spaces and control stations; and
- .5 on deck – at the forward end, midships and the after end of the cargo area. This is only required to be used during cargo handling and gas-freeing operations.

The gas detection system shall be provided with an audible and visual alarm with a set point of 5 ppm.

17.13.4.4 Each cargo tank shall be fitted with a high-pressure alarm giving an audible alarm at a pressure equal to 1.05 MPa gauge.

17.13.5 Personnel protection

The enclosed space required by 17.5.5 shall meet the following requirements:

- .1 the space shall be easily and quickly accessible from the weather decks and from accommodation spaces by means of air locks, and shall be capable of being rapidly closed gastight;
- .2 one of the decontamination showers required by 14.4.3 shall be located near the weather deck airlock to the space;
- .3 the space shall be designed to accommodate the entire crew of the ship and be provided with a source of uncontaminated air for a period of not less than 4 h; and
- .4 one set of oxygen therapy equipment shall be carried in the space.

17.13.6 Filling limits for cargo tanks

17.13.6.1 The requirements of 15.1.3.2 do not apply when it is intended to carry chlorine.

17.13.6.2 (...).

17.14 Ethylene oxide

17.14.1 For the carriage of ethylene oxide, the requirements of 17.18 shall apply, with the additions and modifications as given in this section.

17.14.2 Deck tanks shall not be used for the carriage of ethylene oxide.

17.14.3 Stainless steels types 416 and 442, as well as cast iron, shall not be used in ethylene oxide cargo containment and piping systems.

17.14.4 (...)

17.14.5 Ethylene oxide shall be discharged only by deepwell pumps or inert gas displacement. The arrangement of pumps shall comply with 17.18.15.

17.14.6 (...)

17.14.7 PRVs shall be set at a pressure of not less than 0.55 MPa gauge. The maximum set pressure shall be specially approved by the Administration.

17.14.8 The protective padding of nitrogen gas, as required by 17.18.27, shall be such that the nitrogen concentration in the vapour space of the cargo tank will, at no time, be less than 45% by volume.

17.14.9 (...)

17.14.10 The water-spray system required by 17.18.29 and that required by 11.3 shall operate automatically in a fire involving the cargo containment system.

17.14.11 A jettisoning arrangement shall be provided to allow the emergency discharge of ethylene oxide in the event of uncontrollable self-reaction.

17.15 Separate piping systems

Separate piping systems, as defined in 1.2.47, shall be provided.

17.16 Methyl acetylene-propadiene mixtures

17.16.1 (...)

17.16.2 (...)

17.16.3 (...)

17.16.4 If a ship has a direct vapour compression refrigeration system, this shall comply with the following requirements, subject to pressure and temperature limitations depending on the composition. For the example compositions given in 17.16.2, the following features shall be provided:

- .1** a vapour compressor that does not raise the temperature and pressure of the vapour above 60°C and 1.75 MPa gauge during its operation, and that does not allow vapour to stagnate in the compressor while it continues to run;
- .2** discharge piping from each compressor stage or each cylinder in the same stage of a reciprocating compressor shall have:
 - .1** two temperature-actuated shutdown switches set to operate at 60°C or less;
 - .2** a pressure-actuated shutdown switch set to operate at 1.75 MPa gauge or less; and
 - .3** a safety relief valve set to relieve at 1.8 MPa gauge or less;
- .3** the relief valve required by .2.3 shall vent to a mast meeting the requirements of 8.2.10, 8.2.11 and 8.2.15 and shall not relieve into the compressor suction line; and
- .4** an alarm that sounds in the cargo control position and in the navigation bridge when a high-pressure switch, or a high-temperature switch, operates.

17.16.5 The piping system, including the cargo refrigeration system, for tanks to be loaded with methyl acetylene-propadiene mixtures shall be either independent (as defined in 1.2.28) or separate (as defined in 1.2.47) from piping and refrigeration systems for other tanks. This segregation shall apply to all liquid and vapour vent lines and any other possible connections, such as common inert gas supply lines.

17.17 Nitrogen

Materials of construction and ancillary equipment such as insulation shall be resistant to the effects of high oxygen concentrations caused by condensation and enrichment at the low temperatures attained in parts of the cargo system. Due consideration shall be given to ventilation in areas where condensation might occur, to avoid the stratification of oxygen-enriched atmosphere.

17.18 Propylene oxide and mixtures of ethylene oxide-propylene oxide with ethylene oxide content of not more than 30% by weight

17.18.1 (...)

17.18.2 (...)

17.18.3 (...)

17.18.4 (...)

17.18.5 (...)

17.18.6 Tanks for the carriage of these products shall be of steel or stainless steel construction.

17.18.7 Tanks that have contained these products may be used for other cargoes after thorough cleaning of tanks and associated pipework systems by washing or purging.

17.18.8 All valves, flanges, fittings and accessory equipment shall be of a type suitable for use with these products and shall be constructed of steel or stainless steel in accordance with recognized standards. Disc or disc faces, seats and other wearing parts of valves shall be made of stainless steel containing not less than 11% chromium.

17.18.9 Gaskets shall be constructed of materials which do not react with, dissolve in, or lower the auto-ignition temperature of, these products and which are fire-resistant and possess adequate mechanical behaviour. The surface presented to the cargo shall be polytetrafluoroethylene (PTFE) or materials giving a similar degree of safety by their inertness. Spirally-wound stainless steel with a filler of PTFE or similar fluorinated polymer may be accepted, if approved by the Administration or recognized organization acting on its behalf.

17.18.10 Insulation and packing, if used, shall be of a material which does not react with, dissolve in, or lower the auto-ignition temperature of, these products.

17.18.11 The following materials are generally found unsatisfactory for use in gaskets, packing and similar uses in containment systems for these products and would require testing before being approved:

- .1 neoprene or natural rubber, if it comes into contact with the products;
- .2 asbestos or binders used with asbestos; and
- .3 materials containing oxides of magnesium, such as mineral wools.

17.18.12 Filling and discharge piping shall extend to within 100 mm of the bottom of the tank or any sump.

17.18.13 The products shall be loaded and discharged in such a manner that venting of the tanks to atmosphere does not occur. If vapour return to shore is used during tank loading, the vapour return system connected to a containment system for the product shall be independent of all other containment systems.

17.18.14 (...)

17.18.15 The cargo shall be discharged only by deepwell pumps, hydraulically operated submerged pumps or inert gas displacement. Each cargo pump shall be arranged to ensure that the product does not heat significantly if the discharge line from the pump is shut off or otherwise blocked.

17.18.16 Tanks carrying these products shall be vented independently of tanks carrying other products. Facilities shall be provided for sampling the tank contents without opening the tank to atmosphere.

17.18.17 Cargo hoses used for transfer of these products shall be marked "FOR ALKYLENE OXIDE TRANSFER ONLY".

17.18.18 Hold spaces shall be monitored for these products. Hold spaces surrounding type A and type B independent tanks shall also be inerted and monitored for oxygen. The oxygen content of these spaces shall be maintained below 2% by volume. Portable sampling equipment is satisfactory.

17.18.19 Prior to disconnecting shore lines, the pressure in liquid and vapour lines shall be relieved through suitable valves installed at the loading header. Liquid and vapour from these lines shall not be discharged to atmosphere.

17.18.20 Tanks shall be designed for the maximum pressure expected to be encountered during loading, carriage or unloading of cargo.

17.18.21 Tanks for the carriage of propylene oxide with a design vapour pressure of less than 0.06 MPa, and tanks for the carriage of ethylene oxide-propylene oxide mixtures with a design vapour pressure of less than 0.12 MPa, shall have a cooling system to maintain the cargo below the reference temperature. The reference temperatures are referred to in 15.1.3.

17.18.22 Pressure relief valve settings shall not be less than 0.02 MPa gauge; and for type C independent tanks not greater than 0.7 MPa gauge for the carriage of propylene oxide and not greater than 0.53 MPa gauge for the carriage of ethylene oxide-propylene oxide mixtures.

17.18.23 The piping system for tanks to be loaded with these products shall be completely separate from piping systems for all other tanks, including empty tanks, and from all cargo compressors. If the piping system for the tanks to be loaded with these products is not independent, as defined in 1.2.28, the required piping separation shall be accomplished by the removal of spool pieces, valves, or other pipe sections and the installation of blank flanges at these locations. The required separation applies to all liquid and vapour piping, liquid and vapour vent lines and any other possible connections such as common inert gas supply lines.

17.18.24 The products shall be transported only in accordance with cargo handling plans approved by the Administration. Each intended loading arrangement shall be shown on a separate cargo handling plan. Cargo handling plans shall show the entire cargo piping system and the locations for installation of the blank flanges needed to meet the above piping separation requirements. A copy of each approved cargo handling plan shall be kept on board the ship. The *International Certificate of Fitness for the Carriage of Liquefied Gases in Bulk* shall be endorsed to include references to the approved cargo handling plans.

17.18.25 (...)

17.18.26 The maximum allowable loading limits for each tank shall be indicated for each loading temperature that may be applied, in accordance with 15.5.

17.18.27 The cargo shall be carried under a suitable protective padding of nitrogen gas. An automatic nitrogen make-up system shall be installed to prevent the tank pressure falling below 0.007 MPa gauge in the event of product temperature fall due to ambient conditions or malfunctioning of refrigeration system. Sufficient nitrogen shall be available on board to satisfy the demand of the automatic pressure control. Nitrogen of commercially pure quality (99.9% by volume) shall be used for padding. A battery of nitrogen bottles, connected to the cargo tanks through a pressure reduction valve, satisfies the intention of the expression "automatic" in this context.

17.18.28 (...)

17.18.29 A water-spray system of sufficient capacity shall be provided to blanket effectively the area surrounding the loading manifold, the exposed deck piping associated with product handling and the tank domes. The arrangement of piping and nozzles shall be such as to give a uniform distribution rate of 10 l/m²/min. The arrangement shall ensure that any spilled cargo is washed away.

17.18.30 The water-spray system shall be capable of local and remote manual operation in case of a fire involving the cargo containment system. Remote manual operation shall be arranged such that the remote starting of pumps supplying the water-spray system and remote operation of any normally closed valves in the system can be carried out from a suitable location outside the cargo area, adjacent to the accommodation spaces and readily accessible and operable in the event of fire in the areas protected.

17.18.31 (...)

17.19 Vinyl chloride

In cases where polymerization of vinyl chloride is prevented by addition of an inhibitor, 17.8 is applicable. In cases where no inhibitor has been added, or the inhibitor concentration is insufficient, any inert gas used for the purposes of 17.6 shall contain no more oxygen than 0.1% by volume. (...)

17.20 Mixed C4 cargoes

(...)

17.21 Carbon dioxide: high purity

17.21.1 Uncontrolled pressure loss from the cargo can cause "sublimation" and the cargo will change from the liquid to the solid state. The precise "triple point" temperature of a particular carbon dioxide cargo shall be supplied before loading the cargo, and will depend on the purity of that cargo, and this shall be taken into account when cargo instrumentation is adjusted. The set pressure for the alarms and automatic actions described in this section shall be set to at least 0.05 MPa above the triple point for the specific cargo being carried. The "triple point" for pure carbon dioxide occurs at 0.5 MPa gauge and -54.4°C.

17.21.2 There is a potential for the cargo to solidify in the event that a cargo tank relief valve, fitted in accordance with 8.2, fails in the open position. To avoid this, a means of isolating the cargo tank safety valves shall be provided and the requirements of 8.2.9.2 do not apply when carrying this carbon dioxide. Discharge piping from safety relief valves shall be designed so they remain free from obstructions that could cause clogging. Protective screens shall not be fitted to the outlets of relief valve discharge piping, so the requirements of 8.2.15 do not apply.

17.21.3 Discharge piping from safety relief valves are not required to comply with 8.2.10, but shall be designed so they remain free from obstructions that could cause clogging. Protective screens shall not be fitted to the outlets of relief valve discharge piping, so the requirements of 8.2.15 do not apply.

17.21.4 Cargo tanks shall be continuously monitored for low pressure when a carbon dioxide cargo is carried. An audible and visual alarm shall be given at the cargo control position and on the bridge. If the cargo tank pressure continues to fall to within 0.05 MPa of the "triple point" for the particular cargo, the monitoring system shall automatically close all cargo manifold liquid and vapour valves and stop all cargo compressors and cargo pumps. The emergency shutdown system required by 18.10 may be used for this purpose.

17.21.5 All materials used in cargo tanks and cargo piping system shall be suitable for the lowest temperature that may occur in service, which is defined as the saturation temperature of the carbon dioxide cargo at the set pressure of the automatic safety system described in 17.21.1.

17.21.6 Cargo hold spaces, cargo compressor rooms and other enclosed spaces where carbon dioxide could accumulate shall be fitted with continuous monitoring for carbon dioxide build-up. This fixed gas detection system replaces the requirements of 13.6, and hold spaces shall be monitored permanently even if the ship has type C cargo containment.

17.22 Carbon dioxide: reclaimed quality

17.22.1 The requirements of 17.21 also apply to this cargo. In addition, the materials of construction used in the cargo system shall also take account of the possibility of corrosion, in case the reclaimed quality carbon dioxide cargo contains impurities such as water, sulphur dioxide, etc., which can cause acidic corrosion or other problems.

CHAPTER 18

(IGC Code Chapter 18)

18 OPERATING REQUIREMENTS**Note:**

Chapter 18 of the IGC Code contains mainly operating requirements which are not relevant to these *Rules for the Classification and Construction of Sea-going Gas Tankers*. Consequently operating requirements has not been repeated here only technical requirements and those related to the required documentation operation manuals.

18.1 General

(...)

18.2 Cargo operations manuals

18.2.1 The ship shall be provided with copies of suitably detailed cargo system operation manuals approved by the Administration such that trained personnel can safely operate the ship with due regard to the hazards and properties of the cargoes that are permitted to be carried.

18.2.2 The content of the manuals shall include, but not be limited to:

- .1 overall operation of the ship from dry-dock to dry-dock, including procedures for cargo tank cooldown and warm-up, transfer (including ship-to-ship transfer), cargo sampling, gas-freeing, ballasting, tank cleaning and changing cargoes;
- .2 cargo temperature and pressure control systems;
- .3 cargo system limitations, including minimum temperatures (cargo system and inner hull), maximum pressures, transfer rates, filling limits and sloshing limitations;
- .4 nitrogen and inert gas systems;
- .5 firefighting procedures: operation and maintenance of firefighting systems and use of extinguishing agents;
- .6 special equipment needed for the safe handling of the particular cargo;
- .7 fixed and portable gas detection;
- .8 control, alarm and safety systems;
- .9 emergency shutdown systems;
- .10 procedures to change cargo tank pressure relief valve set pressures in accordance with 8.2.8 and 4.13.2.3; and
- .11 emergency procedures, including cargo tank relief valve isolation, single tank gas-freeing and entry and emergency ship-to-ship transfer operations.

18.3 Cargo information

(...)

18.4 Suitability for carriage

(...)

18.5 Carriage of cargo at low temperature

(...)

18.6 Cargo transfer operations

(...)

18.7 Personnel training

(...)

18.8 Entry into enclosed spaces

(...)

18.9 Cargo sampling

(...)

18.10 Cargo emergency shutdown (ESD) system

18.10.1 General

18.10.1.1 A cargo emergency shutdown system shall be fitted to stop cargo flow in the event of an emergency, either internally within the ship, or during cargo transfer to ship or shore. The design of the ESD system shall avoid the potential generation of surge pressures within cargo transfer pipe work (see 18.10.2.1.4).

18.10.1.2 Auxiliary systems for conditioning the cargo that use toxic or flammable liquids or vapours shall be treated as cargo systems for the purposes of ESD. Indirect refrigeration systems using an inert medium, such as nitrogen, need not be included in the ESD function.

18.10.1.3 The ESD system shall be activated by the manual and automatic initiations listed in table 18.1. Any additional initiations shall only be included in the ESD system if it can be shown that their inclusion does not reduce the integrity and reliability of the system overall.

18.10.1.4 Ship's ESD systems shall incorporate a ship-shore link in accordance with recognized standards ²².

²² ISO 28460:2010 *Petroleum and natural gas industries – Installation and equipment for liquefied natural gas – Ship-to-shore interface and port operations.*

18.10.1.5 A functional flow chart of the ESD system and related systems shall be provided in the cargo control station and on the navigation bridge.

18.10.2 ESD valve requirements

18.10.2.1 General

18.10.2.1.1 The term *ESD valve* means any valve operated by the ESD system.

18.10.2.1.2 ESD valves shall be remotely operated, be of the fail-closed type (closed on loss of actuating power), be capable of local manual closure and have positive indication of the actual valve position. As an alternative to the local manual closing of the ESD valve, a manually operated shut-off valve in series with the ESD valve shall be permitted. The manual valve shall be located adjacent to the ESD valve. Provisions shall be made to handle trapped liquid should the ESD valve close while the manual valve is also closed.

18.10.2.1.3 ESD valves in liquid piping systems shall close fully and smoothly within 30 s of actuation. Information about the closure time of the valves and their operating characteristics shall be available on board, and the closing time shall be verifiable and repeatable.

18.10.2.1.4 The closing time of the valve referred to in 13.3.1 to 13.3.3 (i.e. time from shutdown signal initiation to complete valve closure) shall not be greater than:

$$\frac{3600U}{LR} \quad (\text{second})$$

where:

U = ullage volume at operating signal level (m³);

LR = maximum loading rate agreed between ship and shore facility (m³/h).

The loading rate shall be adjusted to limit surge pressure on valve closure to an acceptable level, taking into account the loading hose or arm, the ship and the shore piping systems, where relevant.

18.10.2.1.5 Fail-close action of Emergency Shut Down (ESD) valve

IACS UR G5

Note:

This UR G5 addresses the fail-close action of ESD valves in association with the requirement in 18.10.2.1.2 for ESD valves of the fail-closed type.

18.10.2.1.5.1 When ESD valve is actuated by hydraulic or pneumatic system, the following shall be complied with.

1. Audible and visible alarm shall be given in the event of loss of pressure that causes activation of fail-close action. The alarm shall be provided in a normally manned control station (e.g. Cargo Control Room and/or the navigation bridge, etc.).
2. The following conditions shall also be complied to ensure the fail-close action:
 1. Failure of hydraulic or pneumatic system shall not lead to loss of fail-close functionality (i.e. activated by spring or weight); or
 2. Hydraulic or pneumatic system for fail-close action shall be arranged with stored power and separated from normal valve operation.

END OF IACS UR G5

18.10.2.2 Ship-shore and ship-ship manifold connections

One ESD valve shall be provided at each manifold connection. Cargo manifold connections not being used for transfer operations shall be blanked with blank flanges rated for the design pressure of the pipeline system.

18.10.2.3 Cargo system valves

If cargo system valves as defined in section 5.5 are also ESD valves within the meaning of 18.10, then the requirements of 18.10 shall apply.

18.10.3 ESD system controls

18.10.3.1 As a minimum, the ESD system shall be capable of manual operation by a single control on the bridge and either in the control position required by 13.1.2 or the cargo control room, if installed, and no less than two locations in the cargo area.

18.10.3.2 The ESD system shall be automatically activated on detection of a fire on the weather decks of the cargo area and/or cargo machinery spaces. As a minimum, the method of detection used on the weather decks shall cover the liquid and vapour domes of the cargo tanks, the cargo manifolds and areas where liquid piping is dismantled regularly. Detection may be by means of fusible elements designed to melt at temperatures between 98°C and 104°C, or by area fire detection methods.

Note: See interpretation in 11.3.1.4.

18.10.3.3 Cargo machinery that is running shall be stopped by activation of the ESD system in accordance with the cause and effect matrix in table 18.1.

18.10.3.4 The ESD control system shall be configured so as to enable the high-level testing required in 13.3.5 to be carried out in a safe and controlled manner. For the purpose of the testing, cargo pumps may be operated while the overflow control system is overridden. Procedures for level alarm testing and re-setting of the ESD system after completion of the high-level alarm testing shall be included in the operation manual required by 18.2.1

Table 18.1 – ESD functional arrangements

	Pumps		Compressor systems			Valves	Link	
	Shutdown action							
Initiation	Cargo pumps/ cargo booster pumps	Spray/ stripping pumps	Vapour return compressors	Fuel gas compressors	Re-liquefaction plant***, including condensate return pumps, if fitted	Gas combustion unit	ESD valves	Signal to ship/shore link****
Emergency push buttons (see 18.10.3.1)	√	√	√	Note 2	√	√	√	√
Fire detection on deck or in compressor house* (see 18.10.3.2)	√	√	√	√	√	√	√	√
High level in cargo tank (see 13.3.2 and 13.3.3)	√	√	√	Note 1 Note 2	Note 1 Note 3	Note 1	Note 6	√
Signal from ship/shore link (see 18.10.1.4)	√	√	√	Note 2	Note 3	n/a	√	n/a
Loss of motive power to ESD valves**	√	√	√	Note 2	Note 3	n/a	√	√
Main electric power failure (“blackout”)	Note 7	Note 7	Note 7	Note 7	Note 7	Note 7	√	√
Level alarm override (see 13.3.7)	Note 4	Note 4 Note 5	√	Note 1	Note 1	Note 1	√	√
<p>Note 1: These items of equipment can be omitted from these specific automatic shutdown initiators, provided the equipment inlets are protected against cargo liquid ingress.</p> <p>Note 2: If the fuel gas compressor is used to return cargo vapour to shore, it shall be included in the ESD system when operating in this mode.</p> <p>Note 3: If the re-liquefaction plant compressors are used for vapour return/shore line clearing, they shall be included in the ESD system when operating in that mode.</p> <p>Note 4: The override system permitted by 13.3.7 may be used at sea to prevent false alarms or shutdowns. When level alarms are overridden, operation of cargo pumps and the opening of manifold ESD valves shall be inhibited except when high-level alarm testing is carried out in accordance with 13.3.5 (see 18.10.3.4).</p> <p>Note: Interpretation in 13.3. also applies to the second sentence of this Note 4.</p> <p>Note 5: Cargo spray or stripping pumps used to supply forcing vaporizer may be excluded from the ESD system only when operating in that mode.</p>								

Note 6:	The sensors referred to in 13.3.2 may be used to close automatically the tank filling valve for the individual tank where the sensors are installed, as an alternative to closing the ESD valve referred to in 18.10.2.2. If this option is adopted, activation of the full ESD system shall be initiated when the high-level sensors in all the tanks to be loaded have been activated.
Note 7:	These items of equipment shall be designed not to restart upon recovery of main electric power and without confirmation of safe conditions.
*	Fusible plugs, electronic point temperature monitoring or area fire detection may be used for this purpose on deck.
**	Failure of hydraulic, electric or pneumatic power for remotely operated ESD valve actuators.
***	Indirect refrigeration systems which form part of the re-liquefaction plant do not need to be included in the ESD function if they employ an inert medium such as nitrogen in the refrigeration cycle.
****	Signal need not indicate the event initiating ESD.
√	Functional requirement.
N/A	Not applicable.

18.10.4 *Additional shutdowns*

18.10.4.1 The requirements of 8.3.1.1 to protect the cargo tank from external differential pressure may be fulfilled by using an independent low pressure trip to activate the ESD system, or, as minimum, to stop any cargo pumps or compressors.

18.10.4.2 An input to the ESD system from the overflow control system required by 13.3 may be provided to stop any cargo pumps or compressors' running at the time a high level is detected, as this alarm may be due to inadvertent internal transfer of cargo from tank to tank.

18.10.5 *Pre-operations testing*

(...)

18.11 **Hot work on or near cargo containment systems**

(...)

18.12 **Additional operating requirements**

(...)

CHAPTER 19
(IGC Code Chapter 19)

19 SUMMARY OF MINIMUM REQUIREMENTS

Explanatory notes to the summary of minimum requirements

Product name (column a)	The product name shall be used in the shipping document for any cargo offered for bulk shipments. Any additional name may be included in brackets after the product name. In some cases, the product names are not identical with the names given in previous issues of these <i>Rules</i> (the Code).
(column b)	<i>Deleted</i>
Ship type (column c)	1: Ship type 1G (2.1.2.1) 2: Ship type 2G (2.1.2.2) 3: Ship type 2PG (2.1.2.3) 4: Ship type 3G (2.1.2.4)
Independent tank type C required (column d)	Type C independent tank (4.23)
Tank environmental control (column e)	Inert: Inerting (9.4) Dry: Drying (17.7) –: No special requirements under these <i>Rules</i> (the Code)
Vapour detection (column f)	F: Flammable vapour detection T: Toxic vapour detection F+T: Flammable and toxic vapour detection A: Asphixiant
Gauging (column g)	I: Indirect or closed (13.2.3.1 and .2) R: Indirect, closed or restricted (13.2.3.1, .2, .3 and .4) C: Indirect or closed (13.2.3.1, .2 and .3)
(column h)	<i>Deleted</i>
Special requirements (column i)	When specific reference is made to Chapters 14 and/or 17, these requirements shall be additional to the requirements in any other column.
Refrigerant gases	Non-toxic and non-flammable gases

Table of products and related minimum requirements

a	b	c	d	e	f	g	h	i
<i>Product name</i>		<i>Ship type</i>	<i>Independent tank type C required</i>	<i>Control of vapour space within cargo tanks</i>	<i>Vapour detection</i>	<i>Gauging</i>		<i>Special requirements</i>
Acetaldehyde		2G/2PG	—	Inert	F + T	C		14.4.3, 14.3.3.1, 17.4.1, 17.6.1
Ammonia, anhydrous		2G/2PG	—	—	T	C		14.4, 17.2.1, 17.12
Butadiene (all isomers)		2G/2PG	—	—	F + T	C		14.4, 17.2.2, 17.4.2, 17.4.3, 17.6, 17.8
Butane (all isomers)		2G/2PG	—	—	F	R		

<i>a</i>	<i>b</i>	<i>c</i>	<i>d</i>	<i>e</i>	<i>f</i>	<i>g</i>	<i>h</i>	<i>i</i>
<i>Product name</i>		<i>Ship type</i>	<i>Independent tank type C required</i>	<i>Control of vapour space within cargo tanks</i>	<i>Vapour detection</i>	<i>Gauging</i>		<i>Special requirements</i>
Butane-propane mixture		2G/2PG	—	—	F	R		
Butylenes (all isomers)		2G/2PG	—	—	F	R		
Carbon Dioxide (high purity)		3G	—	—	A	R		17.21
Carbon Dioxide (Reclaimed quality)		3G	—	—	A	R		17.22
Chlorine		1G	Yes	Dry	T	I		14.4, 17.3.2, 17.4.1, 17.5, 17.7, 17.9, 17.13
Diethyl ether*		2G/2PG	—	Inert	F + T	C		14.4.2, 14.4.3, 17.2.6, 17.3.1, 17.6.1, 17.9, 17.10, 17.11.2, 17.11.3
Dimethylamine		2G/2PG	—	—	F + T	C		14.4, 17.2.1
Dimethyl Ether		2G/2PG	—	—	F + T	C		
Ethane		2G	—	—	F	R		
Ethyl Chloride		2G/2PG	—	—	F + T	C		
Ethylene		2G	—	—	F	R		
Ethylene oxide		1G	Yes	Inert	F + T	C		14.4, 17.2.2, 17.3.2, 17.4.1, 17.5, 17.6.1, 17.14
Ethylene oxide-propylene oxide mixtures with ethylene oxide content of not more than 30% by weight*		2G/2PG	—	Inert	F + T	C		14.4.3, 17.3.1, 17.4.1, 17.6.1, 17.9, 17.10, 17.18
Isoprene* (all isomers)		2G/2PG	—	—	F	R		14.4.3, 17.8, 17.9, 17.11.1
Isoprene (part refined)*		2G/2PG	—	—	F	R		14.4.3, 17.8, 17.9, 17.11.1
Isopropylamine*		2G/2PG	—	—	F + T	C		14.4.2, 14.4.3, 17.2.4, 17.9, 17.10, 17.11.1, 17.15
Methane (LNG)		2G	—	—	F	C		
Methyl acetylene-propadiene mixtures		2G/2PG	—	—	F	R		17.16
Methyl bromide		1G	Yes	—	F + T	C		14.4, 17.2.3, 17.3.2, 17.4.1, 17.5
Methyl chloride		2G/2PG	—	—	F + T	C		17.2.3

<i>a</i>	<i>b</i>	<i>c</i>	<i>d</i>	<i>e</i>	<i>f</i>	<i>g</i>	<i>h</i>	<i>i</i>
<i>Product name</i>		<i>Ship type</i>	<i>Independent tank type C required</i>	<i>Control of vapour space within cargo tanks</i>	<i>Vapour detection</i>	<i>Gauging</i>		<i>Special requirements</i>
Mixed C4 Cargoes		2G/2PG	—	—	F + T	C		14.4, 17.2.2, 17.4.2, 17.4.3, 17.6, 17.20
Monoethylamine*		2G/2PG	—	—	F + T	C		14.4, 17.2.1, 17.3.1, 17.9, 17.10, 17.11.1, 17.15
Nitrogen		3G	—	—	A	C		17.17
Pentane (all isomers)*		2G/2PG	—	—	F	R		17.9, 17.11
Pentene (all isomers)*		2G/2PG	—	—	F	R		17.9, 17.11
Propane		2G/2PG	—	—	F	R		
Propylene		2G/2PG	—	—	F	R		
Propylene oxide*		2G/2PG	—	Inert	F + T	C		14.4.3, 17.3.1, 17.4.1, 17.6.1, 17.9, 17.10, 17.18
Refrigerant gases		3G	—	—	-	R		
Sulphur dioxide		1G	Yes	Dry	T	C		14.4, 17.3.2, 17.4.1, 17.5, 17.7
Vinyl chloride		2G/2PG	—	—	F + T	C		14.4.2, 14.4.3, 17.2.2, 17.2.3, 17.3.1, 17.6, 17.19
Vinyl ethyl ether*		2G/2PG	—	Inert	F + T	C		14.4.2, 14.4.3, 17.2.2, 17.3.1, 17.6.1, 17.8, 17.9, 17.10, 17.11.2, 17.11.3
Vinylidene chloride*		2G/2PG	—	Inert	F + T	C		14.4.2, 14.4.3, 17.2.5, 17.6.1, 17.8, 17.9, 17.10
* This cargo is also covered by the IBC Code.								

APPENDIX 1 IGC CODE PRODUCT DATA REPORTING FORM

Note:

Appendix 1 to the IGC Code contains *Product Data Reporting Form* which is irrelevant to these *Rules for the Classification and Construction of Sea-going Gas Tankers*. Consequently this Appendix 1 remains void.

APPENDIX 2

Model Form of International Certificate of Fitness for the Carriage of Liquefied Gases in Bulk

Note:

Appendix 2 to the IGC Code contains Model Form of *International Certificate of Fitness for the Carriage of Liquefied Gases in Bulk* which is irrelevant to these *Rules for the Classification and Construction of Sea-going Gas Tankers*. Consequently this Appendix 2 remains void.

APPENDIX 3

Example of an addendum to the International Certificate of Fitness for the Carriage of Liquefied Gases in Bulk

Note:

Appendix 3 to the IGC Code contains example of an *Addendum to the International Certificate of Fitness for the Carriage of Liquefied Gases in Bulk* which is irrelevant to these *Rules for the Classification and Construction of Sea-going Gas Tankers*. Consequently this Appendix 3 remains void.

APPENDIX 4 Non-metallic materials

Note:

Provisions of Appendix 4 are recommendatory or informative.

1 General

1.1 The guidance given in this appendix is in addition to the requirements of 4.19, where applicable to non-metallic materials.

1.2 The manufacture, testing, inspection and documentation of non-metallic materials should in general comply with recognized standards, and with the specific requirements of *these Rules* (this Code), as applicable.

1.3 When selecting a non-metallic material, the designer should ensure that it has properties appropriate to the analysis and specification of the system requirements. A material can be selected to fulfil one or more requirements.

1.4 A wide range of non-metallic materials may be considered. Therefore, the section below on material selection criteria cannot cover every eventuality and should be considered as guidance.

2 Material selection criteria

2.1 Non-metallic materials may be selected for use in various parts of liquefied gas carrier cargo systems based on consideration of the following basic properties:

- .1 insulation – the ability to limit heat flow;
- .2 load bearing – the ability to contribute to the strength of the containment system;
- .3 tightness – the ability to provide liquid and vapour tight barriers;
- .4 joining – the ability to be joined (for example by bonding, welding or fastening).

2.2 Additional considerations may apply depending on the specific system design.

3 Properties of materials

3.1 Flexibility of insulating material is the ability of an insulating material to be bent or shaped easily without damage or breakage.

3.2 Loose fill material is a homogeneous solid generally in the form of fine particles, such as a powder or beads, normally used to fill the voids in an inaccessible space to provide an effective insulation.

3.3 Nanomaterial is a material with properties derived from its specific microscopic structure.

3.4 Cellular material is a material type containing cells that are either open, closed or both and which are dispersed throughout its mass.

3.5 Adhesive material is a product that joins or bonds two adjacent surfaces together by an adhesive process.

3.6 Other materials are materials that are not characterized in this section of *these Rules* (the Code) and should be identified and listed. The relevant tests used to evaluate the suitability of material for use in the cargo system should be identified and documented.

4 Material selection and testing requirements

4.1 Material specification

4.1.1 When the initial selection of a material has been made, tests should be conducted to validate the suitability of this material for the use intended.

4.1.2 The material used should clearly be identified and the relevant tests should be fully documented.

4.1.3 Materials should be selected according to their intended use. They should:

- .1 be compatible with all the products that may be carried;
- .2 not be contaminated by any cargo nor react with it;
- .3 not have any characteristics or properties affected by the cargo; and
- .4 be capable to withstand thermal shocks within the operating temperature range.

4.2 Material testing

The tests required for a particular material depend on the design analysis, specification and intended duty. The list of tests below is for illustration. Any additional tests required, for example in respect of sliding, damping and galvanic insulation, should be identified clearly and documented. Materials selected according to 4.1 of this appendix should be tested further according to the following table:

Function	Insulation	Load bearing structural	Tightness	Joining
Mechanical tests		X		X
Tightness tests			X	
Thermal tests	X			

Thermal shock testing should submit the material and/or assembly to the most extreme thermal gradient it will experience when in service.

4.2.1 Inherent properties of materials

4.2.1.1 Tests should be carried out to ensure that the inherent properties of the material selected will not have any negative impact in respect of the use intended.

4.2.1.2 For all selected materials, the following properties should be evaluated:

- .1 density; example standard ISO 845; and
- .2 linear coefficient of thermal expansion (LCTE); example standard ISO 11359 across the widest specified operating temperature range. However, for loose fill material the volumetric coefficient of thermal expansion (VCTE) should be evaluated, as this is more relevant.

4.2.1.3 Irrespective of its inherent properties and intended duty, all materials selected should be tested for the design service temperature range down to 5°C below the minimum design temperature, but not lower than -196°C.

4.2.1.4 Each property evaluation test should be performed in accordance with recognized standards. Where there are no such standards, the test procedure proposed should be fully detailed and submitted to the Administration for acceptance. Sampling should be sufficient to ensure a true representation of the properties of the material selected.

4.2.2 Mechanical tests

4.2.2.1 The mechanical tests should be performed in accordance with the following table.

Mechanical tests	Load bearing structural
Tensile	ISO 527
	ISO 1421
	ISO 3346
	ISO 1926
Shearing	ISO 4587
	ISO 3347
	ISO 1922
	ISO 6237
Compressive	ISO 604
	ISO 844
	ISO 3132
Bending	ISO 3133
	ISO 14679
Creep	ISO 7850

4.2.2.2 If the chosen function for a material relies on particular properties such as tensile, compressive and shear strength, yield stress, modulus or elongation, these properties should be tested to a recognized standard. If the properties required are assessed by numerical simulation according to a high order behaviour law, the testing should be performed to the satisfaction of the Administration.

4.2.2.3 Creep may be caused by sustained loads, for example cargo pressure or structural loads. Creep testing should be conducted based on the loads expected to be encountered during the design life of the containment system.

4.2.3 Tightness tests

4.2.3.1 The tightness requirement for the material should relate to its operational functionality.

4.2.3.2 Tightness tests should be conducted to give a measurement of the material's permeability in the configuration corresponding to the application envisaged (e.g. thickness and stress conditions) using the fluid to be retained (e.g. cargo, water vapour or trace gas).

4.2.3.3 The tightness tests should be based on the tests indicated as examples in the following table.

Tightness tests	Tightness
Porosity/Permeability	ISO 15106
	ISO 2528
	ISO 2782

4.2.4 Thermal conductivity tests

4.2.4.1 Thermal conductivity tests should be representative of the lifecycle of the insulation material so its properties over the design life of the cargo system can be assessed. If these properties are likely to deteriorate over time, the material should be aged as best possible in an environment corresponding to its lifecycle, for example operating temperature, light, vapour and installation (e.g. packaging, bags, boxes, etc.).

4.2.4.2 Requirements for the absolute value and acceptable range of thermal conductivity and heat capacity should be chosen taking into account the effect on the operational efficiency of the cargo containment system. Particular attention should also be paid to the sizing of the associated cargo handling system and components such as safety relief valves plus vapour return and handling equipment.

4.2.4.3 Thermal tests should be based on the tests indicated as examples in the following table or their equivalents:

Thermal tests	Insulating
Thermal conductivity	ISO 8301 ISO 8302
Heat capacity	x

4.2.5 Physical tests

4.2.5.1 In addition to the requirements of 4.19.2.3 and 4.19.3.2, the following table provides guidance and information on some of the additional physical tests that may be considered.

Physical tests	Flexible insulating	Loose fill	Nano-material	Cellular	Adhesive
Particle size		x			
Closed cells content				ISO 4590	
Absorption/Desorption	ISO 12571	x	x	ISO 2896	
Viscosity					ISO 2555 ISO 2431
Open time					ISO 10364
Thixotropic properties					x
Hardness					ISO 868

4.2.5.2 Requirements for loose fill material segregation should be chosen considering its potential adverse effect on the material properties (density, thermal conductivity) when subjected to environmental variations such as thermal cycling and vibration.

4.2.5.3 Requirements for a material with closed cell structures should be based on its eventual impact on gas flow and buffering capacity during transient thermal phases.

4.2.5.4 Similarly, adsorption and absorption requirements should take into account the potential adverse effect an uncontrolled buffering of liquid or gas may have on the system.

5 Quality assurance and quality control (QA/QC)

5.1 General

5.1.1 Once a material has been selected, after testing as outlined in section 4 of this appendix, a detailed quality assurance/quality control (QA/QC) programme should be applied to ensure the continued conformity of the material during installation and service. This programme should consider the material starting from the manufacturer's quality manual (QM) and then follow it throughout the construction of the cargo system.

5.1.2 The QA/QC programme should include the procedure for fabrication, storage, handling and preventive actions to guard against exposure of a material to harmful effects. These may include, for example, the effect of sunlight on some insulation materials or the contamination of

material surfaces by contact with personal products such as hand creams. The sampling methods and the frequency of testing in the QA/QC programme should be specified to ensure the continued conformity of the material selected throughout its production and installation.

5.1.3 Where powder or granulated insulation is produced, arrangements should be made to prevent compacting of the material due to vibrations.

5.2 QA/QC during component manufacture

The QA/QC programme in respect of component manufacture should include, as a minimum but not limited to, the following items.

5.2.1 Component identification

5.2.1.1 For each material, the manufacturer should implement a marking system to clearly identify the production batch. The marking system should not interfere, in any way, with the properties of the product.

5.2.1.2 The marking system should ensure complete traceability of the component and should include:

- .1 date of production and potential expiry date;
- .2 manufacturer's references;
- .3 reference specification;
- .4 reference order; and
- .5 when necessary, any potential environmental parameters to be maintained during transportation and storage.

5.2.2 Production sampling and audit method

5.2.2.1 Regular sampling is required during production to ensure the quality level and continued conformity of a selected material.

5.2.2.2 The frequency, the method and the tests to be performed should be defined in QA/QC programme; for example, these tests will usually cover, inter alia, raw materials, process parameters and component checks.

5.2.2.3 Process parameters and results of the production QC tests should be in strict accordance with those detailed in the QM for the material selected.

5.2.2.4 The objective of the audit method as described in the QM is to control the repeatability of the process and the efficacy of the QA/QC programme.

5.2.2.5 During auditing, auditors should be provided with free access to all production and QC areas. Audit results should be in accordance with the values and tolerances as stated in the relevant QM.

6 Bonding and joining process requirement and testing

6.1 Bonding procedure qualification

6.1.1 The bonding procedure specification and qualification test should be defined in accordance with recognized standards.

6.1.2 The bonding procedures should be fully documented before work commences to ensure the properties of the bond are acceptable.

6.1.3 The following parameters should be considered when developing a bonding procedure specification:

- .1 surface preparation;
- .2 materials storage and handling prior to installation;
- .3 covering-time;
- .4 open-time;
- .5 mixing ratio, deposited quantity;
- .6 environmental parameters (temperature, humidity); and
- .7 curing pressure, temperature and time.

6.1.4 Additional requirements may be included as necessary to ensure acceptable results.

6.1.5 The bonding procedures specification should be validated by an appropriate procedure qualification testing programme.

6.2 Personnel qualifications

6.2.1 Personnel involved in bonding processes should be trained and qualified to recognized standards.

6.2.2 Regular tests should be made to ensure the continued performance of people carrying out bonding operations to ensure a consistent quality of bonding.

7 Production bonding tests and controls

7.1 Destructive testing

During production, representative samples should be taken and tested to check that they correspond to the required level of strength as required for the design.

7.2 Non-destructive testing

7.2.1 During production, tests which are not detrimental to bond integrity should be performed using an appropriate technique such as:

- .1 visual examination;
- .2 internal defects detection (for example acoustic, ultrasonic or shear test); and
- .3 local tightness testing.

7.2.2 If the bonds have to provide tightness as part of their design function, a global tightness test of the cargo containment system should be completed after the end of the erection in accordance with the designer's and QA/QC programme.

7.2.3 The QA/QC standards should include acceptance standards for the tightness of the bonded components when built and during the lifecycle of the containment system.

APPENDIX 5

Standard for the use of limit state methodologies in the design of cargo containment systems of novel configuration

Note: Provisions of Appendix 5 are mandatory.

1 General

1.1 The purpose of this standard is to provide procedures and relevant design parameters of limit state design of cargo containment systems of a novel configuration in accordance with section 4.27 of these *Rules* (this Code).

1.2 Limit state design is a systematic approach where each structural element is evaluated with respect to possible failure modes related to the design conditions identified in section 4.3.4 of these *Rules* (this Code). A limit state can be defined as a condition beyond which the structure, or part of a structure, no longer satisfies the requirements.

1.3 The limit states are divided into the three following categories:

- .1 Ultimate Limit States (ULS), which correspond to the maximum load-carrying capacity or, in some cases, to the maximum applicable strain, deformation or instability in structure resulting from buckling and plastic collapse; under intact (undamaged) conditions;
- .2 Fatigue Limit States (FLS), which correspond to degradation due to the effect of cyclic loading; and
- .3 Accident Limit States (ALS), which concern the ability of the structure to resist accident situations.

1.4 Part A through part D of Chapter 4 of these *Rules* (this Code) shall be complied with as applicable depending on the cargo containment system concept.

2 Design format

2.1 The design format in this standard is based on a Load and Resistance Factor Design format. The fundamental principle of the Load and Resistance Factor Design format is to verify that design load effects, L_d , do not exceed design resistances, R_d , for any of the considered failure modes in any scenario:

$$L_d \leq R_d$$

A design load F_{dk} is obtained by multiplying the characteristic load by a load factor relevant for the given load category:

$$F_{dk} = \gamma_f \cdot F_k$$

where:

γ_f is load factor; and

F_k is the characteristic load as specified in part B and part C of Chapter 4 of these *Rules* (this Code).

A design load effect L_d (e.g. stresses, strains, displacements and vibrations) is the most unfavourable combined load effect derived from the design loads, and may be expressed by:

$$L_d = q(F_{d1}, F_{d2}, \dots, F_{dN})$$

where q denotes the functional relationship between load and load effect determined by structural analyses.

The design resistance R_d is determined as follows:

$$R_d = \frac{R_k}{\gamma_R \cdot \gamma_C}$$

where:

R_k is the characteristic resistance. In case of materials covered by Chapter 6 of these *Rules* (this Code), it may be, but not limited to, specified minimum yield stress, specified minimum tensile strength, plastic resistance of cross sections, and ultimate buckling strength;

γ_R is the resistance factor, defined as $\gamma_R = \gamma_m \cdot \gamma_s$;

γ_m is the partial resistance factor to take account of the probabilistic distribution of the material properties (material factor);

γ_s is the partial resistance factor to take account of the uncertainties on the capacity of the structure, such as the quality of the construction, method considered for determination of the capacity including accuracy of analysis; and

γ_C is the consequence class factor, which accounts for the potential results of failure with regard to release of cargo and possible human injury.

2.2 Cargo containment design shall take into account potential failure consequences. Consequence classes are defined in Table 1, to specify the consequences of failure when the mode of failure is related to the Ultimate Limit State, the Fatigue Limit State, or the Accident Limit State.

Table 1: Consequence classes

Consequence class	Definition
Low	Failure implies minor release of the cargo.
Medium	Failure implies release of the cargo and potential for human injury.
High	Failure implies significant release of the cargo and high potential for human injury/fatality.

3 Required analyses

3.1 Three dimensional finite element analyses shall be carried out as an integrated model of the tank and the ship hull, including supports and keying system as applicable. All the failure modes shall be identified to avoid unexpected failures. Hydrodynamic analyses shall be carried out to determine the particular ship accelerations and motions in irregular waves, and the response of the ship and its cargo containment systems to these forces and motions.

3.2 Buckling strength analyses of cargo tanks subject to external pressure and other loads causing compressive stresses shall be carried out in accordance with recognized standards. The method shall adequately account for the difference in theoretical and actual buckling stress as a result of plate out of flatness, plate edge misalignment, straightness, ovality and deviation from true circular form over a specified arc or chord length, as relevant.

3.3 Fatigue and crack propagation analysis shall be carried out in accordance with paragraph 5.1 of this standard.

4 Ultimate Limit States

4.1 Structural resistance may be established by testing or by complete analysis taking account of both elastic and plastic material properties. Safety margins for ultimate strength shall be introduced by partial factors of safety taking account of the contribution of stochastic nature of loads and resistance (dynamic loads, pressure loads, gravity loads, material strength, and buckling capacities).

4.2 Appropriate combinations of permanent loads, functional loads and environmental loads including sloshing loads shall be considered in the analysis. At least two load combinations with partial load factors as given in table 2 shall be used for the assessment of the ultimate limit states.

Table 2: Partial load factors

Load combination	Permanent loads	Functional loads	Environmental loads
'a'	1.1	1.1	0.7
'b'	1.0	1.0	1.3

The load factors for permanent and functional loads in load combination 'a' are relevant for the normally well-controlled and/or specified loads applicable to cargo containment systems such as vapour pressure, cargo weight, system self-weight, etc. Higher load factors may be relevant for permanent and functional loads where the inherent variability and/or uncertainties in the prediction models are higher.

4.3 For sloshing loads, depending on the reliability of the estimation method, a larger load factor may be required by the Administration or recognized organization acting on its behalf.

4.4 In cases where structural failure of the cargo containment system are considered to imply high potential for human injury and significant release of cargo, the consequence class factor shall be taken as $\gamma_c = 1.2$. This value may be reduced if it is justified through risk analysis and subject to the approval by the Administration or recognized organization acting on its behalf. The risk analysis shall take account of factors including, but not limited to, provision of full or partial secondary barrier to protect hull structure from the leakage and less hazards associated with intended cargo. Conversely, higher values may be fixed by the Administration or recognized organization acting on its behalf, for example, for ships carrying more hazardous or higher pressure cargo. The consequence class factor shall in any case not be less than 1.0.

4.5 The load factors and the resistance factors used shall be such that the level of safety is equivalent to that of the cargo containment systems as described in sections 4.21 to 4.26 of these *Rules* (this Code). This may be carried out by calibrating the factors against known successful designs.

4.6 The material factor γ_m shall in general reflect the statistical distribution of the mechanical properties of the material, and needs to be interpreted in combination with the specified characteristic mechanical properties. For the materials defined in Chapter 6 of these *Rules* (this Code), the material factor γ_m may be taken as:

- 1.1 when the characteristic mechanical properties specified by the recognized organization typically represents the lower 2.5% quantile in the statistical distribution of the mechanical properties; or
- 1.0 when the characteristic mechanical properties specified by the recognized organization represents a sufficiently small quantile such that the probability of lower mechanical properties than specified is extremely low and can be neglected.

4.7 The partial resistance factors γ_{si} shall in general be established based on the uncertainties in the capacity of the structure considering construction tolerances, quality of construction, the accuracy of the analysis method applied, etc.

4.7.1 For design against excessive plastic deformation using the limit state criteria given in paragraph 4.8 of this standard, the partial resistance factors γ_{si} shall be taken as follows:

$$\gamma_{s1} = 0.76 \cdot \frac{B}{\kappa_1}$$

$$\gamma_{s2} = 0.76 \cdot \frac{D}{\kappa_2}$$

$$\kappa_1 = \text{Min} \left(\frac{R_m}{R_e} \cdot \frac{B}{A}; 1.0 \right)$$

$$\kappa_2 = \text{Min} \left(\frac{R_m}{R_e} \cdot \frac{D}{C}; 1.0 \right)$$

Factors A, B, C and D are defined in section 4.22.3.1 of these *Rules* (this Code). R_m and R_e are defined in section 4.18.1.3 of these *Rules* (this Code).

The partial resistance factors given above are the results of calibration to conventional type B independent tanks.

4.8 Design against excessive plastic deformation

4.8.1 Stress acceptance criteria given below refer to elastic stress analyses.

4.8.2 Parts of cargo containment systems where loads are primarily carried by membrane response in the structure shall satisfy the following limit state criteria:

$$\sigma_m \leq f$$

$$\sigma_L \leq 1.5f$$

$$\sigma_b \leq 1.5F$$

$$\sigma_L + \sigma_b \leq 1.5F$$

$$\sigma_m + \sigma_b \leq 1.5F$$

$$\sigma_m + \sigma_b + \sigma_g \leq 3.0F$$

$$\sigma_L + \sigma_b + \sigma_g \leq 3.0F$$

where:

- σ_m = equivalent primary general membrane stress
- σ_L = equivalent primary local membrane stress
- σ_b = equivalent primary bending stress
- σ_g = equivalent secondary stress

$$f = \frac{R_e}{\gamma_{s1} \cdot \gamma_m \cdot \gamma_C}$$

$$F = \frac{R_e}{\gamma_{s2} \cdot \gamma_m \cdot \gamma_C}$$

With regard to the stresses σ_m , σ_L , σ_b and σ_g , see also the definition of stress categories in section 4.28.3 of these *Rules* (this Code).

Guidance Note:

The stress summation described above shall be carried out by summing up each stress component (σ_x , σ_y , τ_{xy}), and subsequently the equivalent stress shall be calculated based on the resulting stress components as shown in the example below.

$$\sigma_L + \sigma_b = \sqrt{(\sigma_{Lx} + \sigma_{bx})^2 - (\sigma_{Lx} + \sigma_{bx})(\sigma_{Ly} + \sigma_{by}) + (\sigma_{Ly} + \sigma_{by})^2 + 3(\tau_{Lxy} + \tau_{bxy})^2}$$

4.8.3 Parts of cargo containment systems where loads are primarily carried by bending of girders, stiffeners and plates, shall satisfy the following limit state criteria:

$$\sigma_{ms} + \sigma_{bp} \leq 1.25F \text{ (See notes 1, 2)}$$

$$\sigma_{ms} + \sigma_{bp} + \sigma_{bs} \leq 1.25F \text{ (See note 2)}$$

$$\sigma_{ms} + \sigma_{bp} + \sigma_{bs} + \sigma_{bt} + \sigma_g \leq 3.0F$$

Note 1: The sum of equivalent section membrane stress and equivalent membrane stress in primary structure ($\sigma_{ms} + \sigma_{bp}$) will normally be directly available from three-dimensional finite element analyses.

Note 2: The coefficient, 1.25, may be modified by the Administration or recognized organization acting on its behalf considering the design concept, configuration of the structure, and the methodology used for calculation of stresses.

where:

σ_{ms} = equivalent section membrane stress in primary structure

σ_{bp} = equivalent membrane stress in primary structure and stress in secondary and tertiary structure caused by bending of primary structure

σ_{bs} = section bending stress in secondary structure and stress in tertiary structure caused by bending of secondary structure

σ_{bt} = section bending stress in tertiary structure

σ_g = equivalent secondary stress

$$f = \frac{R_e}{\gamma_{s1} \cdot \gamma_m \cdot \gamma_C}$$

$$F = \frac{R_e}{\gamma_{s2} \cdot \gamma_m \cdot \gamma_C}$$

The stresses σ_{ms} , σ_{bp} , σ_{bs} , and σ_{bt} are defined in 4.8.4. For a definition of σ_g , see section 4.28.3 of these Rules (this Code).

Guidance Note:

The stress summation described above shall be carried out by summing up each stress component (σ_x , σ_y , τ_{xy}), and subsequently the equivalent stress shall be calculated based on the resulting stress components.

Skin plates shall be designed in accordance with the requirements of the Administration or recognized organization acting on its behalf. When membrane stress is significant, the effect of the membrane stress on the plate bending capacity shall be appropriately considered in addition.

4.8.4 Section stress categories

Normal stress is the component of stress normal to the plane of reference.

Equivalent section membrane stress is the component of the normal stress that is uniformly distributed and equal to the average value of the stress across the cross section of the structure under consideration. If this is a simple shell section, the section membrane stress is identical to the membrane stress defined in paragraph 4.8.2 of this standard.

Section bending stress is the component of the normal stress that is linearly distributed over a structural section exposed to bending action, as illustrated in figure 1.

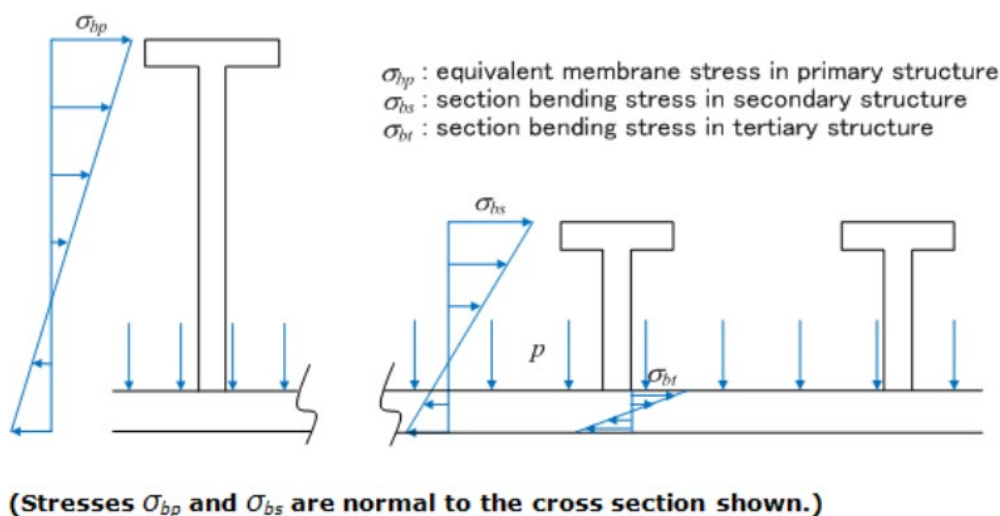

Figure 1: Definition of the three categories of section stress

4.9 The same factors $\gamma_C, \gamma_m, \gamma_{si}$ shall be used for design against buckling unless otherwise stated in the applied recognized buckling standard. In any case the overall level of safety shall not be less than given by these factors.

5 Fatigue Limit States

5.1 Fatigue design condition as described in section 4.18.2 of these Rules (this Code) shall be complied with as applicable depending on the cargo containment system concept. Fatigue analysis is required for the cargo containment system designed under section 4.27 of these Rules (this Code) and this standard.

5.2 The load factors for FLS shall be taken as 1.0 for all load categories.

5.3 Consequence class factor γ_C and resistance factor γ_R shall be taken as 1.0.

5.4 Fatigue damage shall be calculated as described in sections 4.18.2.2 to 4.18.2.5 of these Rules (this Code). The calculated cumulative fatigue damage ratio for the cargo containment systems shall be less than or equal to the values given in table 3.

Table 3: Maximum allowable cumulative fatigue damage ratio

C_w	Consequence class		
	Low	Medium	High
	1.0	0.5	0.5*
Note:			
* Lower value shall be used in accordance with sections 4.18.2.7 to 4.18.2.9 of these Rules (this Code), depending on the detectability of defect or crack, etc.			

5.5 Lower values may be fixed by the Administration or recognized organization acting on its behalf, for example for tank structures where effective detection of defect or crack cannot be assured, and for ships carrying more hazardous cargo.

5.6 Crack propagation analyses are required in accordance with sections 4.18.2.6 to 4.18.2.9 of these Rules (this Code). The analysis shall be carried out in accordance with methods laid down in a standard recognized by the Administration or recognized organization acting on its behalf.

6 Accident Limit States

6.1 Accident design condition as described in section 4.18.3 of these *Rules* (this Code) shall be complied with as applicable, depending on the cargo containment system concept.

6.2 Load and resistance factors may be relaxed compared to the ultimate limit state considering that damages and deformations can be accepted as long as this does not escalate the accident scenario.

6.3 The load factors for ALS shall be taken as 1.0 for permanent loads, functional loads and environmental loads.

6.4 Loads mentioned in section 4.13.9 (Static heel loads) and section 4.15 (Collision and Loads due to flooding on ship) of these *Rules* (this Code) need not be combined with each other or with environmental loads, as defined in section 4.14 of these *Rules* (this Code).

6.5 Resistance factor γ_R shall in general be taken as 1.0.

6.6 Consequence class factors γ_C shall in general be taken as defined in paragraph 4.4 of this standard, but may be relaxed considering the nature of the accident scenario.

6.7 The characteristic resistance R_k shall in general be taken as for the ultimate limit state, but may be relaxed considering the nature of the accident scenario.

6.8 Additional relevant accident scenarios shall be determined based on a risk analysis.

7 Testing

7.1 Cargo containment systems designed according to this standard shall be tested to the same extent as described in section 4.20.3 of these *Rules* (this Code), as applicable depending on the cargo containment system concept.

List of external reference documentsIMO documents

1. *International Convention for the Safety of Life at Sea, 1974 (SOLAS Convention)*
2. *International Convention for the Prevention of Pollution from Ships, 1973, as modified by the Protocol of 1978 relating thereto (MARPOL Convention)*
3. *International Convention on Load Lines, 1966, as amended by the 1988 Protocol (LL Convention)*
4. *International Code for the Construction and Equipment of Ships Carrying Liquefied Gases in Bulk (IGC Code)*
5. *International Code of Safety for Ships Using Gases or Other Low-flashpoint Fuels (IGF Code)*
6. *International Code for the Construction and Equipment of Ships Carrying Dangerous Chemicals in Bulk (IBC Code)*
7. A.829(19) *Guidelines for the evaluation of the adequacy of type C tank vent systems*
8. MSC/Circ.406/Rev.1 *Guidelines on interpretation of the IBC Code and the IGC Code and Guidelines for the uniform application of the survival requirements of the IBC and IGC Codes*
9. MSC.1/Circ.1543 *Unified interpretations relating to the IGC Code*
10. MSC.1/Circ.1559 *Unified interpretations of the IGC Code*
11. MSC.1/Circ.1590 *Unified interpretations of paragraph 13.3.5 of the IGC Code (as amended by resolution MSC.370(93))*
12. MSC.1/Circ.1599/Rev.3 *Revised guidelines on the application of high manganese austenitic steel for cryogenic service*
13. MSC.1/Circ.1606 *Unified interpretations of the IGC Code (as amended by resolution MSC.370(93))*
14. MSC.1/Circ.1617 *Unified interpretations of the IGC Code*
15. MSC.1/Circ.1622/Rev.1 *Guidelines for the acceptance of alternative metallic materials for cryogenic service in ships carrying liquefied gases in bulk and ships using gases or other low-flashpoint fuel.*
16. MSC.1/Circ.1625 *Unified interpretations of the IGC Code*
17. MSC.370(93) *Amendments to the International Code for the Construction and Equipment of Ships Carrying Liquefied Gases In Bulk (IGC Code)*
18. MSC.411(97) *Amendments to the International Code for the Construction and Equipment of Ships Carrying Liquefied Gases In Bulk (IGC Code)*
19. MSC.476(102) *Amendments to the International Code for the Construction and Equipment of Ships Carrying Liquefied Gases In Bulk (IGC Code)*
20. MSC.492(104) *Amendments to the International Code for the Construction and Equipment of Ships Carrying Liquefied Gases In Bulk (IGC Code)*
21. MSC.523(106) *Amendments to the International Code for the Construction and Equipment of Ships Carrying Liquefied Gases In Bulk (IGC Code)*
22. MSC.566(109) *Amendments to the International Code for the Construction and Equipment of Ships Carrying Liquefied Gases In Bulk (IGC Code)*

IACS resolutions

1. PR35 Rev.1 *Procedure for Imposing and Clearing Recommendations/Conditions of Class*
2. UI GC1 Rev.2 *Interpretation of sub-section 3.9(b), BCH Code*
3. UI GC7 Rev.1 *Carriage of products not covered by the code*
4. UI GC8 Rev.1 *Permissible stresses in way of supports of type C cargo tanks*
5. UI GC9 Rev.1 *Guidance for sizing pressure relief systems for interbarrier spaces*
6. UI GC12 Rev.2 *Secondary barrier testing requirements*
7. UI GC13 Rev.3 *Verifications before and after the first loaded voyage*
8. UI GC14 *Pump Vents in Machinery Spaces*
9. UI GC15 Rev.1 *Closing Devices for Air Intakes*
10. UI GC16 *Cargo tank clearances (on ships constructed on or after 1 July 2016)*
11. UI GC17 *Unprotected openings*
12. UI GC18 Corr.1 *Test for cargo tank's high level alarm*
13. UI GC19 *External surface area of the tank for determining sizing of pressure relief valve (paragraph 8.4.1.2 and figure 8.1)*
14. UI GC20 *Tee welds in type A or type B independent tanks*
15. UI GC21 *Welds of type C independent bi-lobe tank with centreline bulkhead*
16. UI GC22 Rev.1 *Water spray system*

17. UI GC23 Corr.1 *Cargo tank structure heating arrangement power supply*
18. UI GC24 Rev.1 *Fire Test for Emergency Shutdown Valves*
19. UI GC25 Rev.1 *Cargo piping insulation*
20. UI GC26 Corr.1 *Type testing requirements for valves*
21. UI GC27 Corr.1 *Level indicators for cargo tanks*
22. UI GC28 Rev.1 Corr.1 *Guidance for sizing pressure relief systems for interbarrier spaces*
23. UI GC29 Corr.1 *Integrated systems*
24. UI GC30 *Emergency fire pump*
25. UI GC31 *Discharge test of dry chemical powder fire-extinguishing systems*
26. UI GC32 Rev.1 *Outer Duct in Gas Fuel Piping Systems*
27. UI GC33 *Cargo Sampling*
28. UI GC34 *Cargo Filters*
29. UI GC35 *Inhibition of Cargo Pump Operation and Opening of Manifold ESD valves with Level Alarms Overridden*
30. UI GC36 *Oxygen Deficiency Monitoring Equipment in a Nitrogen Generator Room Area*
31. UI GC37 *Suitable Pressure Relief System for Air Inlet, Scavenge Spaces, Exhaust System and Crank Case*
32. UI GC38 *Deck areas above F.O. tanks installed at the after end of the aftermost hold space*
33. UI GC39 *Interpretation of 2014 IGC Code (MSC.370(93), as amended) Paragraphs 11.3.1, 11.4.1, 11.4.3 and 18.10.3.2 w.r.t additional bunkering manifold equipment fitted on L.N.G. Bunkering Ships*
34. UR G1 Rev.3 Corr.3 *Vessels with cargo containment system for liquefied gas*
35. UR G2 Rev.3 *Liquefied gas cargo tanks and process pressure vessels*
36. UR G3 Rev.8 *Liquefied gas cargo and process piping*
37. UR G5 *Fail-close action of Emergency Shut Down (ESD) valve*
38. UR W1 Rev.4 *Material and welding for ships carrying liquefied gases in bulk and ships using gases or other low-flashpoint fuels*
39. UR W11 Rev.9 *Normal and higher strength hull structural steels*
40. UR W16 Rev.3 *High strength steels for welded structures*
41. UR Z7 Rev.28 *Hull classification surveys*
42. UR Z7.2 Rev.8 *Hull surveys for liquefied gas carriers*
43. UR Z16 Rev.4 Corr.1 *Periodical surveys of cargo installations on ships carrying liquefied gases in bulk*
44. UR Z17 *Procedural requirements for service suppliers*
45. REC. 42 Rev.2 *Guidelines for Use of Remote Inspection Techniques for Surveys*
46. REC. 120 *Survey of electrical equipment installed in hazardous areas on tankers*
47. REC. 150 *Vapour pockets not in communication with cargo tank vapour/liquid domes on liquefied gas carriers*
48. REC. 174 *Recommended procedure for the finite element analysis to assess yielding, buckling and fatigue strength of IGC Code type C tanks*

International standards

1. ISO 845 *Cellular plastics and rubbers – Determination of apparent density*
2. ISO 13709:2009 *Centrifugal pumps for petroleum, petrochemical and natural gas industries*
3. ISO 24490:2016 *Cryogenic vessels – Pumps for cryogenic service*
4. ISO 4126-1; 2004 *Safety devices for protection against excessive pressure – part 1 and part 4: Safety valves*
5. ISO 7919-3:2009/AMD 1:2017, *Mechanical vibration – Evaluation of machine vibration by measurements on rotating shafts – Part 3 Coupled industrial machines*
6. ISO 10816-3:2009/AMD 1: 2017, *Evaluation of machine vibration by measurements on non-rotating parts – Part 3: Industrial machines with nominal power above 15 kW and nominal speeds between 120 r/min and 15 000 r/min when measured in situ*
7. ISO 10816-7:2009, *Mechanical vibration – Evaluation of machine vibration by measurements on non-rotating parts – Part 7: Rotodynamic pumps for industrial applications, including measurements on rotating shafts*
8. ISO 10816-7:2009, *Mechanical vibration – Evaluation of machine vibration by measurements on non-rotating parts – Part 8: Reciprocating compressor system*
9. ISO 11359 *Plastics — Thermomechanical analysis (TMA)*
10. ISO/IEC 15288:2008 *Systems and software engineering – System life cycle processes, and ISO 17894:2005 Ships and marine technology – Computer applications – General principles for the development and use of programmable electronic systems in marine applications*
11. ISO 20816-1:2016, *Mechanical vibration – Measurement and evaluation of machine vibration – Part 1: General Guidelines*
12. ISO 20816-8:2018, *Mechanical vibration – Measurement and evaluation of machine vibration – Part 8: Reciprocating compressor systems*

13. ISO 21013-1:2008 *Cryogenic vessels – Pressure-relief accessories for cryogenic service – part 1: Recloseable pressure-relief valve*
14. ISO 28460:2010 *Petroleum and natural gas industries – Installation and equipment for liquefied natural gas – Ship-to-shore interface and port operations*
15. IEC 60079-29-1 *Explosive atmospheres – Gas detectors – Performance requirements of detectors for flammable gases*
16. IEC 60092-502:1999 *Electrical installations in ships – Tankers – Special features*
17. IEC 60092-504:2001 *Electrical installations in ships – Special features – Control and instrumentation*
18. IEC 60812, Edition 2.0 2006-01 *Analysis techniques for system reliability – Procedure for failure mode and effects analysis (FMEA)*

Other standards

1. API standard 617:2014 (w. Errata 1:2016) *Axial and Centrifugal Compressors and Expander-compressors*
 2. API standard 618:2016 or 619:2010 *Reciprocating Compressors for Petroleum, Chemical, and Gas Industry Services*
-

List of amendments as of 1 January 2026

<i>Item</i>	<i>Title/Subject</i>	<i>Source</i>
Table 6.3	Requirements for high manganese austenitic steel added.	MSC.523(106)
List of external reference documents	New IMO resolution added.	PRS

List of amendments as of 1 July 2026

<i>Item</i>	<i>Title/Subject</i>	<i>Source</i>
16.9.2	Use of cargo as fuel	MSC.566(109)
List of external reference documents	New IMO resolution added	PRS