



**RULES  
FOR THE CLASSIFICATION AND CONSTRUCTION  
OF SEA-GOING SHIPS**

**PART IX  
MATERIALS AND WELDING**

July  
2024

GDAŃSK

## **RULES FOR CLASSIFICATION AND CONSTRUCTION OF SEA-GOING SHIPS**

prepared and issued by Polish Register of Shipping, hereinafter referred to as PRS, consist of the following parts:

- Part I – Classification Regulations
- Part II – Hull
- Part III – Hull Equipment
- Part IV – Stability and Subdivision
- Part V – Fire Protection
- Part VI – Ship and Machinery Piping Systems
- Part VII – Main and Auxiliary Machinery and Equipment
- Part VIII – Electrical Installations and Control Systems
- Part IX – Materials and Welding.

*Part IX – Materials and Welding – July 2024*, was approved by PRS Executive Board on 13 June 2024 and enters into force on 1 July 2024.

From the entry into force, the requirements of *Part IX – Materials and Welding* apply, in full, to new ships.

For existing ships, the requirements of *Part IX – Materials and Welding* are applicable within the scope specified in *Part I – Classification Regulations*.

The requirements of *Part IX – Materials and Welding* are extended by the following publications:

- Publication 7/P – Repair of Cast Copper Alloy Propellers,
- Publication 23/P – Pipelines Prefabrication,
- Publication 30/P – Principles for Certification of Welders
- Publication 34/P – Inspection of Underwater Welded Joints,
- Publication 40/P – Non-metallic Materials,
- Publication 48/P – Requirements Concerning Gas Tankers,
- Publication 56/P – Procedural Requirements for Laboratories,
- Publication 70/P – Non-destructive Testing of Hull and Machinery Steel Forgings,
- Publication 71/P – Non-destructive Testing of Hull Marine Steel Castings,
- Publication 74/P – Principles for Welding Procedure Qualification Tests,
- Publication 80/P – Non-destructive Testing,
- Publication 117/P – Using LNG or other Low-Flashpoint Fuels onboard Ships other than Gas Carriers.

© Copyright by Polish Register of Shipping\*, 2024

---

\* *Polish Register of Shipping means Polski Rejestr Statków S.A., seated in Gdańsk, al. gen. Józefa Hallera 126, 80-416 Gdańsk, Poland, registered in the Register of Entrepreneurs of the National Court Register, under entry number 0000019880. Polish Register of Shipping, its affiliates and subsidiaries, their respective officers, employees or agents are, individually and collectively, referred to as Polish Register of Shipping or as PRS for short.*

# CONTENTS

	Page
<b>1 General</b> .....	9
1.1 Application .....	9
1.2 Definitions, Explanations, Symbols, Abbreviations and Normative References .....	9
1.3 Scope of Survey .....	14
1.4 Technical Documentation.....	14
1.5 Approval of Materials'/Products' Manufacturers.....	15
1.6 Approval of Welded Structures' Manufacturers.....	16
1.7 Survey of Materials'/Products' Manufacture .....	16
1.8 Inspection Certificate.....	17
1.9 Marking.....	17
<b>2 Testing</b> .....	19
2.1 General Requirements .....	19
2.2 Testing Laboratories.....	19
2.3 Re-Tests .....	20
2.4 Chemical Analysis.....	20
2.5 Tensile Test.....	20
2.6 Impact Test.....	24
2.7 Bend Test .....	25
2.8 Pellini Dropweight Test (DWT) .....	26
2.9 Hardness Testing.....	26
2.10 Macroscopic and Microscopic Examinations .....	26
2.11 Ductility Tests for Pipes and Tubes.....	26
2.12 ESSO Test .....	28
2.13 Weldability Test.....	31
2.14 Non-Destructive Testing .....	32
2.15 Other Tests .....	32
<b>MATERIALS</b> .....	33
<b>3 Normal and Higher Strength Hull Structural Steel</b> .....	34
3.1 Scope of Application.....	34
3.2 Approval of Manufacturer .....	34
3.3 Methods of Manufacture .....	35
3.4 Chemical Composition.....	37
3.5 Supply Condition .....	39
3.6 Mechanical Properties.....	40
3.7 Surface Quality and Internal Soundness .....	42
3.8 Inspection of Surface and Work Quality.....	43
3.9 Test Material.....	46
3.10 Mechanical Test Specimens.....	48
3.11 Number of Test Specimens.....	48
3.12 Retest Procedures.....	49
3.13 Marking .....	52
3.14 Inspection Certificate.....	52
3.15 Additional Requirements for Corrosion Resistant Steel Used as the Alternative Means of Corrosion Protection for Cargo Oil Tanks.....	53
3.16 Additional Requirements for YP47 Steels and Brittle Crack Arrest Steels .....	53
<b>4 High Strength Steels</b> .....	57
4.1 Application .....	57

4.2	Approval.....	57
4.3	Manufacturing Methods .....	58
4.4	Chemical Composition.....	58
4.5	Supply Condition .....	59
4.6	Mechanical Properties.....	60
4.7	Tolerances .....	63
4.8	Surface and Work Quality.....	63
4.9	Stress-relieving Heat Treatment and Other Heat Treatments .....	64
4.10	Facilities for Inspection.....	64
4.11	Material Identification .....	64
4.12	Marking .....	64
4.13	Inspection Certificate.....	64
<b>5</b>	<b>Steel with Specified through Thickness Properties (Steel “Z”)</b> .....	<b>66</b>
5.1	General Requirements .....	66
5.2	Reduction of Area.....	66
5.3	Testing.....	67
5.4	Marking.....	69
5.5	Inspection Certificate.....	69
<b>6</b>	<b>Steel for Boilers and Pressure Vessels .....</b>	<b>70</b>
6.1	General Requirements .....	70
6.2	Steel Grades .....	70
6.3	Chemical Composition.....	70
6.4	Mechanical Properties.....	72
6.5	Supply Condition .....	74
6.6	Testing.....	74
6.7	Inspection of Surface and Work Quality.....	75
6.8	Marking.....	76
6.9	Inspection Certificate.....	76
<b>7</b>	<b>Steel for Low Temperature Service.....</b>	<b>77</b>
7.1	Steel for Hull Structures .....	77
7.2	Steels for Construction of Liquefied Gas Tankers.....	77
7.3	Steels for Other Structures.....	77
<b>8</b>	<b>Stainless Steels .....</b>	<b>78</b>
8.1	General Requirements .....	78
8.2	Chemical Composition.....	78
8.3	Mechanical Properties.....	78
8.4	Supply Condition .....	78
8.5	Testing.....	80
8.6	Inspection of Surface and Work Quality.....	85
8.7	Marking.....	85
8.8	Inspection Certificate.....	85
<b>9</b>	<b>Clad Steels.....</b>	<b>86</b>
9.1	General Requirements .....	86
9.2	Chemical Composition.....	86
9.3	Mechanical Properties.....	86
9.4	Supply Condition .....	86
9.5	Testing.....	86
9.6	Inspection of Surface and Work Quality.....	88
9.7	Marking.....	88
9.8	Inspection Certificate.....	88

<b>10 Steel tubes</b> .....	89
10.1 General Requirements .....	89
10.2 Manufacturing Techniques .....	89
10.3 Chemical Composition .....	89
10.4 Mechanical Properties .....	89
10.5 Supply Condition .....	93
10.6 Testing .....	93
10.7 Inspection of Surface and Work Quality .....	94
10.8 Marking .....	94
10.9 Inspection Certificate .....	94
<b>11 Rolled Steels for Anchor Chain Cables</b> .....	95
11.1 General Requirements .....	95
11.2 Manufacturing Procedures .....	95
11.3 Supply Condition .....	95
11.4 Chemical Composition .....	95
11.5 Mechanical Tests .....	95
11.6 Inspection of Surface and Work Quality .....	96
11.7 Freedom from Defects .....	97
11.8 Marking .....	97
11.9 Inspection Certificate .....	97
<b>12 Steel Forgings</b> .....	98
12.1 General Requirements .....	98
12.2 Manufacturing Procedure .....	98
12.3 Quality of Forgings .....	99
12.4 Chemical Composition .....	99
12.5 Supply Condition .....	100
12.6 Mechanical Tests .....	101
12.7 Mechanical Properties .....	106
12.8 Inspection of Surface and Work Quality .....	108
12.9 Rectification of Defective Forgings .....	109
12.10 Identification of Forgings .....	109
12.11 Marking .....	109
12.12 Inspection Certificate .....	109
<b>13 Steel Castings</b> .....	110
13.1 Carbon Steel Castings for Hull and Machinery Components .....	110
13.2 Cast Stainless Steel Propellers .....	117
<b>14 Grey Iron Castings</b> .....	124
14.1 General Requirements .....	124
14.2 Manufacture .....	124
14.3 Quality of Castings .....	124
14.4 Chemical Composition .....	124
14.5 Supply Condition .....	124
14.6 Mechanical Tests .....	124
14.7 Mechanical Properties .....	126
14.8 Inspection of Surface and Work Quality .....	127
14.9 Rectification of Defective Castings .....	127
14.10 Marking .....	128
14.11 Inspection Certificate .....	128
<b>15 Nodular Iron Castings</b> .....	129
15.1 General Requirements .....	129

15.2	Manufacture .....	129
15.3	Quality of Castings.....	129
15.4	Chemical Composition .....	129
15.5	Supply Condition .....	129
15.6	Mechanical Tests.....	130
15.7	Mechanical Properties .....	131
15.8	Inspection of Surface and Work Quality .....	132
15.9	Metallographic Examination.....	132
15.10	Rectification of Defective Castings .....	132
15.11	Marking .....	133
15.12	Inspection Certificate .....	133
<b>16</b>	<b>Malleable Iron Castings .....</b>	<b>134</b>
<b>17</b>	<b>Copper Alloys.....</b>	<b>134</b>
17.1	Copper and Copper Alloy Tubes.....	134
17.2	Copper Alloy Castings other than Castings for Propellers .....	136
17.3	Cast Copper Alloys for Propellers.....	139
<b>18</b>	<b>Aluminium Alloys.....</b>	<b>144</b>
18.1	Wrought Aluminium Alloys.....	144
18.2	Aluminium Alloy Castings.....	151
<b>19</b>	<b>Requirements for Manufacture of Anchors .....</b>	<b>154</b>
19.1	General Requirements .....	154
19.2	Materials .....	154
19.3	Manufacture of Anchors.....	155
19.4	Testing and Certification .....	156
<b>20</b>	<b>Anchor Chain Cables and Accessories.....</b>	<b>161</b>
20.1	General Requirements .....	161
20.2	Materials .....	161
20.3	Design and Manufacture of Chain Cables and Accessories.....	162
20.4	Testing and Inspection Certificate of Finished Chain Cables .....	165
20.5	Testing and Inspection Certificate for Accessories.....	169
20.6	Chafing Chain for ETA Equipment.....	170
<b>21</b>	<b>Steel Wire Ropes.....</b>	<b>172</b>
21.1	General Requirements .....	172
21.2	Manufacture .....	172
21.3	Tests.....	172
21.4	Inspection of Surface and Work Quality .....	175
21.5	Marking .....	175
21.6	Inspection Certificate .....	175
<b>22</b>	<b>Fibre Ropes.....</b>	<b>176</b>
22.1	General Requirements .....	176
22.2	Manufacture .....	176
22.3	Tests.....	176
22.4	Inspection of Surface and Work Quality .....	178
22.5	Marking .....	178
22.6	Inspection Certificate .....	178
<b>23</b>	<b>Welding.....</b>	<b>180</b>
23.1	General.....	180
23.2	Welding of Ship Hull and its Equipment.....	181

23.3	Welding of Machinery .....	183
23.4	Welding of Boilers and Pressure Vessels.....	184
23.5	Welding of Pipelines .....	185
23.6	Welding of Stainless Steels.....	185
23.7	Welding of Stainless Steels with other Steels .....	185
23.8	Welding of Clad Steels with Austenitic Stainless Steels .....	185
23.9	Welding of Steel Forgings and Castings.....	186
23.10	Welding of Cast Iron.....	186
23.11	Welding of Copper and Copper Alloys .....	187
23.12	Welding of Wrought Aluminium Alloys.....	187
23.13	Hard Soldering.....	187
<b>24</b>	<b>Welding Consumables .....</b>	<b>188</b>
24.1	General Requirements .....	188
24.2	Approval Procedure .....	189
24.3	Preparation and Testing of Welding Consumables Test Assemblies .....	190
24.4	Assessment of Results of Tests of Welding Consumables for Hull Structure Steels.....	192
24.5	Approval Tests of Covered Electrodes for Manual Arc Welding of Hull Structural Steels.....	194
24.6	Approval Tests of Welding Consumables for Submerged Arc Welding of Hull Structural Steels.	200
24.7	Approval Tests of Wires without and with Shielding Gas .....	204
24.8	Approval Tests of Consumables for Use in Electroslag and Electrogas Welding.....	207
24.9	Approval Tests of Consumables for One Side Welding on Backing Strips .....	209
24.10	Approval Tests of Welding Consumables for High Strength Steels.....	209
24.11	Approval Tests of Welding Consumables for Boiler Steels.....	213
24.12	Approval Tests of Welding Consumables for Machinery, Equipment and Piping Steels.....	213
24.13	Approval Tests of Welding Consumables for Stainless and Clad Steels.....	214
24.14	Approval Tests of Welding Consumables for Copper, Heavy Metals and other on-Ferrous Metals.....	215
24.15	Approval Tests of Welding Consumables for Aluminium Alloys.....	215
24.16	Approval Tests of Welding Consumables for YP47 steels.....	218
<b>25</b>	<b>Welded structure manufacturers .....</b>	<b>219</b>
25.1	General Requirements .....	219
25.2	Approval Procedure .....	220
25.3	Technical Documentation.....	220
25.4	Manufacturer Inspection.....	220
25.5	Welding Procedure Qualification .....	221
<b>Appendix A</b>	<b>- Approval Procedure for Manufacturer of Hull Structural Steels .....</b>	<b>223</b>
<b>Appendix B</b>	<b>- Approval Procedure for Manufacturer of Hull Structural Steels Intended for Welding with High Heat Input .....</b>	<b>234</b>
<b>Appendix C</b>	<b>- Approval Procedure for Manufacturer of Corrosion Resistant Steel Used as Alternative Means of Corrosion Protection for Cargo Oil Tanks .....</b>	<b>238</b>
<b>Appendix D</b>	<b>- Approval Procedure for Manufacturer of High Strength Steel for the Container Carrier Hull Construction .....</b>	<b>239</b>
<b>Appendix E</b>	<b>- Approval Procedure for Manufacturer of High Strength Steels for Welded Structures.....</b>	<b>241</b>
<b>Appendix F</b>	<b>- Approval Procedure for Manufacturer of YP47 Steels .....</b>	<b>250</b>
<b>Appendix G</b>	<b>- Approval Procedure for Manufacturer of Brittle Crack Arrest Steels .....</b>	<b>251</b>





## 1 GENERAL

### 1.1 Application

**1.1.1** *Part IX – Materials and Welding* applies to materials, including welding consumables, used for the construction and repair of the following ship structures which are subject to PRS survey:

- hull,
- machinery and machinery installations,
- steam boilers and pressure vessels,
- hull equipment,
- piping systems.

**1.1.2** The requirements specified in this *Part* also apply to materials, including welding consumables and welding processes, used for the construction and repair of other structures which are subject to PRS survey.

**1.1.3** When selecting materials, the requirements specified in other *Parts* of PRS Rules shall be taken into account.

**1.1.4** Materials which, due to their chemical composition and mechanical properties, do not fulfil the requirements specified in this *Part* of the *Rules* are subject to PRS acceptance in each particular case.

**1.1.5** Additional requirements for materials, including welding consumables, and welding processes used for the construction and repair of ships using LNG or other low-flashpoint fuel, other than gas carriers, are given in *Publication 117/P – Using LNG or other Low-Flashpoint Fuels onboard Ships other than Gas Carriers*.

**1.1.6** Non-metallic organic materials and products, as well as plastics not covered by this *Part*, subject to PRS survey according to the requirements specified in other *Parts* of the *Rules* shall fulfil the requirements given in *Publication 40/P – Non-Metallic Materials*.

### 1.2 Definitions, Explanations, Symbols, Abbreviations and Normative References

The definitions and explanations relating to the general terminology of the *Rules for the Classification and Construction of Sea-Going Ships* (hereinafter referred to as the *Rules*) are specified in *Part I – Classification Regulations*. For the purpose of this *Part*, additional definitions, explanations and symbols specified in sub-chapters 1.2.1 and 1.2.2 have been adopted.

#### 1.2.1 Definitions and Explanations

*As rolled condition* (AR) – supply condition without any additional special rolling and/or heat treatment.

*Chain diameter* [mm] – nominal diameter of the particular chain, corresponding to the common link cross-section diameter.

*Controlled rolling* (CR) or *normalising rolling* (NR) – a rolling procedure in which the final deformation is performed in the normalizing temperature range, resulting in a material condition generally equivalent to that obtained by normalizing.

*Heat affected zone* (HAZ) – metal area in the welded joint adjacent to the weld, undergoing changes of structural, physical, mechanical and other properties under the effect of welding heat.

*Heat input* (*linear energy*) – the amount of heat energy supplied to the welded material during a welding run of unit length.

*Impact energy* (KV) [J] – amount of energy used to break a specimen of the defined temperature.

*Isothermal annealing (I)* – heat treatment process in which steel is heated to an appropriate temperature above  $A_{c3}$ , and subsequently cooled to an appropriate temperature not exceeding  $A_{c1}$  and kept in constant temperature and then cooled. The process aims to obtain good toughness properties.

*Manufacturer* – factory (steelworks, forging shop, foundry, rolling mill, etc.) producing materials or products which are subject to PRS survey.

*Normalising (N)* – heat treatment process that involves austenitising and subsequent cooling in still air.

*One-side welding* – welding process where the whole weld is made from one side of a welded joint only.

*Parent material* – material from which the element to be welded is made.

*Preliminary welding procedure specification (pWPS)* – welding procedure specification prepared by the manufacturer, which will constitute the basis for welding procedure qualification tests.

*Quenching (Q)* – heat treatment process where steel is heated to a temperature above  $A_{c3}$  and then cooled in order to harden its structure.

*Quenching and tempering (QT)* – heat treatment process in high temperature to obtain desirable mechanical properties, in particular good toughness and good plasticity.

*Sample* – piece of test product from which test specimens are taken. In the case of castings, sample may be integrally cast or gated.

*Specimen* – section of the material taken from the sample, with specified shape and dimensions, to be subjected to mechanical, technological and other tests.

*Supply condition* – the final heat treatment of the material in delivery condition (e.g. as rolled (AR), normalised (N), normalised and tempered (NT), quenched and tempered (QT), thermomechanical rolling (TM), controlled rolling (CR), isothermal annealing (I) etc.).

*Tempering (T)* – heat treatment process where steel is heated to a temperature below  $A_{c1}$  in order to restore its ductility through structure improvement.

*Test product* – product taken from a batch to be checked and/or subjected to examination.

*Thermo-mechanical rolling (TM)* – procedure which involves strict control of both the steel temperature and rolling reduction to obtain the properties which cannot be reproduced by other heat treatment without plastic strain. Thermo-mechanical rolling may or may not include accelerated cooling, and may or may not include direct quenching followed by tempering after TM-rolling.

*Test assembly* – welded joint made for the purpose of examination of the properties of welding consumables, correctness of technological process used or for checking the welder's qualifications.

*Test batch* – a number of products (items) or mass of products which are together approved or rejected as a result of the tests performed in accordance with the requirements specified in the *Rules* or in the order placed.

*Weld* – part of a welded joint made of the material melted during the welding process.

*Welded joint scheme* – list of particulars about the individual joints in welded structures. Cases, in which it is required to submit the welded joint scheme and the range of information to be contained therein, are determined by the *Rules*.

*Welding consumable* – material constituting the weld or which allows the weld to be made; it may be e.g. covered electrode, welding rod, wire, flux or gas.

*Welding imperfection* – weld metal discontinuity or deviation from the assumed weld geometry.

*Welding Procedure Qualification Record (WPQR)* – record including all the required particulars of the test assembly welding, as well as the results of all tests of the welded test assembly performed during the welding procedure qualification.

*Welding Procedure Specification (WPS)* – a document stating details of variable parameters required for a specified welding process and ensuring that welded joints made in accordance with this document satisfy quality uniformity criteria.

*Weld layer* – one or several weld runs deposited side by side at one level.

*Weld run* – metal melted or deposited under one heat source passage.

### 1.2.2 Explanations

*A* [%] – relative elongation of specimen after fracture – percentage elongation determined on a proportional gauge length  $L_0$  ( $L_0 = 5.65 \cdot \sqrt{S_0}$  for proportional flat test specimens,  $L_0 = 5d_0$  for proportional round test specimens).

For proportional flat test specimens whose initial gauge length is different from  $5.65 \cdot \sqrt{S_0}$ , symbol *A* shall be assigned an index representing the proportionality factor, e.g.:

$A_{11.3}$  – relative elongation for original gauge length ( $L_0$ ) corresponding to  $11.3 \cdot \sqrt{S_0}$ .

In the case of specimens with non-proportional gauge length, symbol *A* shall be assigned an index representing the original gauge length in millimetres, e.g.:

$A_{200\text{ mm}}$  – relative elongation for original gauge length ( $L_0$ ) of 200 mm.

The elongation value is valid if the distance between the fracture and the nearest gauge mark is not less than one third of the original gauge length ( $L_0$ ).

*KV* [J] – impact energy value (energy absorbed by a fractured specimen) determined by Charpy V-notch impact test on a specimen defined in sub-chapter 2.6 of this *Part*.

$R_e$ , [MPa] – yield stress (yield point) – stress at which strain increases without an increase in tensile force.

Unless stated otherwise, the values of  $R_e$  mentioned in this *Part* and in other *Parts* of the *Rules* shall be identified with  $R_{eH}$ .

$R_{p0.2}$  [MPa] – proof stress (yield strength) – stress determined at non-proportional strain equal to 0.2% of extensometer gauge length ( $L_0$ ); in technically justified cases, proof stress may be determined for other permanent elongation values within 0.05 to 1.0%.

$R_m$  [MPa] – tensile strength – stress corresponding to the maximum tensile force.

*Z* [%] – relative reduction of area – the maximum reduction in the cross-section area during the tensile test related to its initial cross-section area ( $S_0$ ).

### 1.2.3 Symbols and Abbreviations

*A* – relative elongation of specimen after fracture,

AR – as rolled,

CR – controlled rolling,

*D* – former diameter,

*d* – specimen diameter,

I – isothermal annealing,

*KV* – impact energy value,

- MT – magnetic-particle testing,
- N – normalising,
- NDT – non-destructive testing,
- NR – normalising rolling,
- NT – normalising and tempering,
- PT – penetrant testing,
- pWPS – preliminary welding procedure specification,
- Q – quenching,
- QT – quenching and tempering,
- $R_e$  – yield stress,
- $R_m$  – tensile strength,
- $R_{p0,2}$  – proof stress (yield strength) – determined at non-proportional strain,
- RT – radiographic testing,
- HAZ – heat affected zone,
- $t$  – thickness of product,
- T – tempering,
- UT – ultrasonic testing,
- VT – visual testing,
- WPQR – welding procedure qualification record,
- WPS – welding procedure specification,
- Z – relative reduction of area.

#### 1.2.4 Normative references

- PN-EN 515 – Aluminium and aluminium alloys – Wrought products – Temper designations.
- PN-EN 573-1 – Aluminium and aluminium alloys – Chemical composition and form of wrought products – Part 1: Numerical designation system.
- PN-EN 573-2 – Aluminium and aluminium alloys – Chemical composition and form of wrought products – Part 2: Chemical designation system.
- PN-EN 1057 – Copper and copper alloys – Seamless, round copper tubes for water and gas in sanitary and heating applications.
- PN-EN 1561 – Founding – Grey cast irons.
- PN-EN 10028-2 – Flat products made of steels for pressure purposes – Part 2: Non-alloy and alloy steels with specified elevated temperature properties.
- PN-EN 10029 – Hot rolled steel plates 3 mm thick or above – Tolerances on dimensions, shape and mass.
- PN-EN 10160 – Ultrasonic testing of steel flat product of thickness equal or greater than 6 mm (reflection method).
- PN-EN 10164 – Steel products with improved deformation properties perpendicular to the surface of the product – Technical delivery conditions.
- PN-EN 10204 – Metallic products – Types of inspection documents.
- PN-EN 10216-2 – Seamless steel tubes for pressure purposes – Technical delivery conditions – Part 2: Non-alloy and alloy steel tubes with specified elevated temperature properties.
- PN-EN 10264-1 – Steel wire and wire products – Steel wire for ropes – Part 1: General requirements.

- PN-EN 10264-2 – Steel wire and wire products – Steel wire for ropes – Part 2: Cold drawn non alloy steel wire for ropes for general applications.
- PN-EN 10314 – Method for the derivation of minimum values of proof strength of steel at elevated temperatures.
- PN-EN 12385-2 – Steel wire ropes – Safety – Part 2: Definitions, designation and classification.
- PN-EN 12385-4 – Steel wire ropes – Safety – Part 4: Stranded ropes for general lifting applications.
- PN-EN 12449 – Copper and copper alloys – Seamless, round tubes for general purposes.
- PN-EN 12451 – Copper and copper alloys – Seamless round tubes for heat exchanges.
- PN-EN ISO 945-1 – Microstructure of cast irons – Part 1: Graphite classification by visual analysis.
- PN-EN ISO 2307 – Fibre ropes – Determination of certain physical and mechanical properties.
- PN-EN ISO 3452-1 – Non-destructive testing – Penetrant testing – Part 1: General principles.
- PN-EN ISO 3651-1 – Determination of resistance to intergranular corrosion of stainless steels – Part 1: Austenitic and ferritic-austenitic (duplex) stainless steels – Corrosion test in nitric acid medium by measurement of loss in mass (Huey test).
- PN-EN ISO 3651-2 – Determination of resistance to intergranular corrosion of stainless steels – Part 2: Ferritic, austenitic and ferritic-austenitic (duplex) stainless steels – Corrosion test in media containing sulphuric acid.
- PN-EN ISO 3785 – Metallic materials – Designation of test specimen axes in relation to product texture.
- PN-EN ISO 6506-1 – Metallic materials – Brinell hardness test – Part 1: Test method.
- PN-EN ISO 6507-1 – Metallic materials – Vickers hardness test – Part 1: Test method.
- PN-EN ISO 6508-1 – Metallic materials – Rockwell hardness test – Part 1: Test method
- PN-EN ISO 6892-1 – Metallic materials – Tensile testing – Part 1: Method of test at room temperature.
- PN-EN ISO 6892-2 – Metallic materials – Tensile testing – Part 2: Method of test at elevated temperature.
- PN-EN ISO 7438 – Metallic materials – Bends test.
- PN-EN ISO 8492 – Metallic materials – Tube – Flattening test.
- PN-EN ISO 8493 – Metallic materials – Tube – Drift-expanding test.
- PN-EN ISO 8494 – Metallic materials – Tube – Flanging test.
- PN-EN ISO 8495 – Metallic materials – Tube – Ring-expanding test.
- PN-EN ISO 8496 – Metallic materials – Tube – Ring tensile test.
- PN-EN ISO 9001 – Quality management systems – Requirements.
- PN-EN ISO 9554 – Fibre ropes – General specifications.
- PN-EN ISO/IEC 17025 – General requirements for the competence of testing and calibration laboratories.
- PN-EN ISO 17639 – Destructive test on welds in metallic materials – Macroscopic and microscopic examination of welds.
- PN-ISO 1704 – Shipbuilding – Stud-link anchor chains.
- ISO 3108 – Steel wire ropes for general purposes – Determination of actual breaking load
- PN-H-92140 – Steel plate with corrosion resisting steel single side plated.
- ASTM A262-15 – Standard Practices for Detecting Susceptibility to Intergranular Attack in Austenitic Stainless Steels.

ASTM A578 – Standard Specification for Straight – Beam Ultrasonic Examination of Plain and Clad Steel Plates for Special Applications.

ASTM E165-18 – Standard Test Method for Liquid Penetrant Examination.

ASTM E208-17 – Standard Test Method for Conducting Drop – Weight Test to Determine Nil – Ductility Transition Temperature of Ferritic Steels.

ASTM G66-99 – Standard Test Method for Visual Assessment of Exfoliation Corrosion Susceptibility of 5xxx Series Aluminium Alloys (ASSET Test).

ASTM G67-04 – Standard Test Method for Determining the Susceptibility to Intergranular Corrosion of 5xxx Series Aluminium Alloys by Mass Loss after Exposure to Nitric Acid (NAMLT Test).

IMO MSC.1/Circ. 1599/Rev. 2 Interim Guidelines on the Application of High Manganese Austenitic Steel for Cryogenic Service.

### 1.3 Scope of Survey

1.3.1 General provisions concerning the scope and procedure of survey are specified in PRS *General Survey Regulations*.

1.3.2 PRS survey during manufacture covers the following materials/products:

- .1 rolled products from hull structural steel and aluminium alloys,
- .2 rolled products from steel intended for Class I and II boilers and pressure vessels,
- .3 steel tubes for Class I and II boilers, pressure vessels and piping systems,
- .4 steel forgings and castings of essential parts,
- .5 propeller castings,
- .6 chain cables and ropes,
- .7 anchors,
- .8 welding consumables.

1.3.3 PRS survey of manufacture covers the following:

- .1 consideration of technical documentation,
- .2 inspection – survey of materials during manufacture and tests,
- .3 issuing of the relevant PRS documents (material certificates, certificates, statements, etc.).

1.3.4 PRS survey of welding applies to the structures which are subject to PRS survey and covers the following:

- .1 ensuring that the requirements of PRS *Rules* relevant to welded joints and application of parent materials and welding consumables are fulfilled,
- .2 ensuring that the requirements concerning the welding procedures included in this *Part* and in the accepted technological documentation are fulfilled,
- .3 inspection of welded joints in accordance with the requirements specified in *Publication 80/P – Non-destructive Testing*.

### 1.4 Technical Documentation

#### 1.4.1 General Requirements

1.4.1.1 Sub-chapter 1.4 specifies the requirements for technical and technological documentation which shall be agreed with PRS if PRS survey covers:

- survey during manufacture of materials/products (plates, sections, castings, forgings, etc.),
- survey of welded structures manufacture.

The above documentation shall be submitted to PRS prior to the commencement of survey.

**1.4.1.2** In the case when survey refers to repair of welded structures, the requirements of sub-chapter 1.4 shall be regarded as guidelines, while the detailed scope of the required documentation shall be agreed with PRS in each particular case. The scope of the required documentation will depend on the extent of repair.

## **1.4.2 Technical Documentation Relating to Materials/Products**

**1.4.2.1** The documentation relating to materials and products shall contain/specify:

- types (grades) of materials according to the *Rules* or standards,
- characteristics of the material (product), its chemical composition, mechanical and technological properties; this requirement applies only in cases where the material type (grade) is not specified in the *Rules* or the relevant standards,
- the method of manufacture,
- the manufacture process description,
- standards and/or technical specifications stating acceptance requirements.

**1.4.2.2** The scope of the required information relating to the manufacture processes shall be agreed with PRS in each particular case.

## **1.4.3 Technical Documentation Relating to Welded Structures**

**1.4.3.1** The documentation relating to the survey of welded structures shall contain:

- technical documentation of materials/products listed in 1.4.2,
- technological documentation connected with welding work, complying with the requirements of the present Part of the *Rules* (Chapters 23, 24, 25),
- non-destructive testing plan, complying with the requirements of *Publication 80/P – Non-destructive Testing*,
- coating specification for ballast tanks; applies only to ships of 500 gross tonnage and upwards.

## **1.5 Approval of Materials'/Products' Manufacturers**

**1.5.1** Manufacturers of the materials specified in paragraph 1.3.2 and semi-finished products used for their manufacture shall be approved by PRS.

**1.5.2** Request for approval shall include the following data:

- characteristics of the material (the chemical composition, mechanical and technological properties, etc.),
- designation of the material, the manufacturing and quality control procedures,
- particulars of raw materials,
- proposed scope of approval.

The request shall also contain information on the previous experience of the manufacturer in the production of materials subject to approval. The approval granted shall not be transferred to branches or other factories and any changes of the material manufacturing method shall be reported to PRS.

**1.5.3** Tests connected with the manufacturer approval are conducted in accordance with the *Tests' Programme* prepared by the manufacturer and accepted by PRS in each particular case. The approval tests shall be performed under the direct survey by PRS in the laboratory approved by PRS.

**1.5.4** Approval of manufacturing process and manufacturers of hull steel intended for high heat input welding shall be issued in accordance with the procedures specified in Annex A or Annex B to Chapter 3 of this Part, respectively.

**1.5.5** Within the approval procedure, PRS conducts inspection at the manufacturers requesting the approval.

**1.5.6** Approval is renewed upon the manufacturer request and after the relevant inspection has been conducted again.

**1.5.7** The above mentioned approval procedure also applies to the already approved manufacturers wishing to extend the existing scope of approval or manufacturers introducing new methods of material production, not provided for in this Part.

## **1.6 Approval of Welded Structures' Manufacturers**

Manufacturers of steel welded structures, i.e. shipyards and other works shall be approved by PRS in accordance with the requirements specified in Chapter 25 of this *Part*. The approval tests programme depends on the expected welding work and is subject to PRS acceptance in each particular case.

## **1.7 Survey of Materials'/Products' Manufacture**

### **1.7.1 Direct Survey**

**1.7.1.1** Materials/products, specified in paragraph 1.3.2, except welding consumables, are subject to PRS direct survey during manufacture. The survey covers inspection and testing of materials within the scope determined in this *Part*, the relevant standards or agreed material specifications.

Surface inspection and verification of dimensions, mass of materials and products are the responsibility of the manufacturer. Issuance, by PRS, of the *Inspection Certificate* for the material or product later found defective or not meeting the standards or material specifications in respect of the material dimensions, mass or the surface condition does not absolve the manufacturer from this responsibility.

**1.7.1.2** Prior to acceptance tests, the manufacturer shall furnish PRS with the following particulars:

- name, type or grade of material,
- name and number of standard,
- grade of material in accordance with this *Part* or order specifications,
- supply condition,
- purchaser's name and the object (if known) for which the material is intended,
- quantity of the supplied material (number of pieces, weight, etc.),
- cast number, identification number,
- identification number of tests or test specimens.

**1.7.1.3** Approval tests of the material are performed after the technological operations (e.g. after heat treatment) affecting the material properties are complete.

### **1.7.2 Indirect Survey**

PRS conducts indirect survey of welding consumables' manufacture. The procedure for approval of welding consumables is specified in Chapter 24 of this *Part*.

PRS may approve series-production of certain materials manufactured by the works approved in accordance with the requirements specified in sub-chapter 1.5, the workmanship of which fulfils the quality requirements for materials and may issue *Type Approval Certificate* for such materials. This Certificate entitles the manufacturer's duly authorized personnel to conduct inspections and to issue the relevant documents.



General principles concerning the issue of *Type Approval Certificates* and indirect survey procedure are specified in *Supervision Activity Regulations*.

## 1.8 Inspection Certificate

**1.8.1** *Inspection Certificate* is issued in accordance with the requirements specified in standard PN-EN 10204.

**1.8.2** *Inspection Certificate* shall include, apart from dimensions and quantity of the supplied material (*number of pieces, weight, etc.*) the following particulars:

- purchaser's name and the object (if known) for which the material is intended,
- cast number, identification number,
- manufacturer's name,
- grade of material in accordance with this *Part* or order specifications,
- chemical composition,
- supply condition,
- results of mechanical tests,
- results of technological testing (if any),
- results of corrosion tests (if any).

**1.8.3** If the test results obtained during direct survey fulfil the requirements specified in this *Part*, PRS issues the *Inspection Certificate*. Before the *Inspection Certificate* has been issued, the manufacturer shall produce a written declaration stating that the product has been made in accordance with the approved procedure and fulfils the relevant requirements specified in this *Part*.

The following form of such a declaration is accepted by PRS:

*It is hereby certified that the product has been made in accordance with the approved procedure and it fulfils the requirements specified in PRS Rules*

signed by the duly authorized manufacturer's representative.

**1.8.4** Each *Inspection Certificate* issued by the manufacturer for a product being type-approved by PRS through *Type Approval Certificate* shall contain the following clause:

*PRS TYPE APPROVED PRODUCT*  
*Type Approval Certificate*  
*No. ....*  
*Valid until ..... ..*

## 1.9 Marking

**1.9.1** Materials shall be marked in accordance with recognised standards taking into account the following requirements.

**1.9.2** Where products are delivered in single pieces, each one shall be marked.

**1.9.3** Where products are delivered in bundles or packages, two weather-resistant labels containing the marks shall be provided and fastened to the opposite ends of the bundle or directly on the package.

**1.9.4** In the case of delivery of small size products, their marking is subject to PRS acceptance in each particular case.

**1.9.5** Products shall be marked, as far as practicable, in places that are not likely to be further machine treated.



**1.9.6** The marks shall stand out clearly and shall be framed with a bright paint resistant to atmosphere.

**1.9.7** In each case, the marks on products shall contain at least the following particulars:

- .1 category or grade of material,
- .2 number of cast, number of batch or other marking allowing to ascertain that the product belongs to the batch for which the *Inspection Certificate* has been issued,
- .3 manufacturer's name or brand,
- .4 manufacturer's control stamp,
- .5 *Inspection Certificate* number,
- .6 PRS stamp.

**1.9.8** In the case of any marked material showing defects that prevent its intended use, the marks shall be removed.

---

## 2 TESTING

### 2.1 General Requirements

**2.1.1** Materials which are subject to PRS survey during manufacture shall be submitted to tests. The type of tests and criteria of the test results assessment shall be in accordance with the requirements specified in *Part IX- Materials and Welding*, unless stated otherwise in other Parts of the *Rules*.

**2.1.2** The present Chapter specifies the test conditions, types and dimensions of specimens, as well as requirements relating to test specimens preparation.

PRS may agree to the use of test methods and specimen types other than those stated in the present Chapter, provided they enable proper identification and evaluation of the material properties.

**2.1.3** Unless stated otherwise in the *Rules*, the types and particulars of special tests of materials / products intended for specific use, as well as the criteria of the tests results' assessment are subject to PRS acceptance in each particular case.

**2.1.4** During tests, the requirements of relevant standards or material specifications agreed with PRS shall also be fulfilled.

**2.1.5** Samples shall be heat-treated together (in one furnace charge) with the product or part to which they belong. Test specimens shall be prepared in a manner that will not affect the material properties.

### 2.2 Testing Laboratories

**2.2.1** The provisions specified in this sub-chapter apply to laboratories engaged in testing of the materials and products which are subject to PRS survey.

**2.2.2** Testing shall be performed in the laboratories approved by PRS. The criteria for approval of such laboratories are specified in *Publication 56/P – Procedural Requirements for Laboratories*.

**2.2.3** Laboratories of approved materials/products manufacturers are entitled to conduct chemical analysis of materials/products necessary for acceptance of the material/product, without special approval granted by PRS for this purpose.

Test results of these laboratories will constitute sufficient grounds for the chemical composition data to be entered in the *Inspection Certificate*.

**2.2.4** PRS may approve – on a case by case basis – a laboratory or test results obtained in a laboratory not approved by PRS through the *Approval Certificate* provided the following conditions are fulfilled:

- the tests will be performed in the presence of PRS Surveyor (if possible),
- testing equipment is checked periodically,
- personnel conducting the tests is suitably qualified,
- laboratory has a quality management system implemented.

**2.2.5** Testing shall be conducted at a temperature corresponding to the requirements of the relevant standards unless stated otherwise in other chapters of this *Part* of the *Rules*.

**2.2.6** Tension/compression machines shall be calibrated in accordance with ISO 7500-1:2018 or other recognised standard. Impact testing machines shall be calibrated in accordance with ISO 148-2:2016 or other recognised standard.

## 2.3 Re-Tests

**2.3.1** If the obtained test results are unsatisfactory, the tests may be repeated subject to the following conditions:

- .1 if unsatisfactory test results are due to local defects in the specimen material, faulty machining of specimens or faulty test equipment, the test shall be repeated on the same number of specimens;
- .2 when the tensile test fails to meet the requirements, two further tests may be made from the same piece. If both of these additional tests satisfy the requirements of this *Part*, the item and batch are acceptable. If one or both of these tests fail, the item and batch shall be rejected. The additional tests detailed above shall be performed using the specimens taken, preferably from material taken adjacent to the original test specimens, but alternatively from another test position or sample representative of the item;
- .3 when the average impact test energy values obtained on three specimens fail to meet the requirement or when two results obtained are below the required value, or when one result is less than 70% of the required value, the tests may be performed on the additional set of specimens consisting of three specimens taken from the same product. The product or the batch of products may be accepted, provided that the average value of all results obtained from the first or second series of tests is at least equal to the required value and when not more than two results, among all the results obtained, are below the required value or when not more than one result is less than 70% of the required value;
- .4 if the properties of the material can be improved by heat treatment, then, after the treatment, the test shall be repeated on the standard number of specimens;
- .5 if, to ensure the required mechanical properties of alloy steels, the manufacturer is compelled to subject the steels to heat treatment for the second time, the process of such treatment is subject to PRS acceptance in each particular case;
- .6 where, based on the tests of some pieces in a batch, the batch of material is rejected, then, at the option of the manufacturer, the remaining pieces in the batch may be submitted individually for tests and those pieces which give satisfactory results may be accepted.

**2.3.2** PRS may require the tests to be repeated (in the presence of the Surveyor) if confusion of specimens or test results has taken place or the test results do not allow for determining the material quality with the required accuracy.

## 2.4 Chemical Analysis

Permissible deviations from the results of ladle analysis – in the case of check analysis of the finished products – shall be in accordance with the relevant standards or the requirements of this *Part*.

## 2.5 Tensile Test

**2.5.1** At the tensile test, the following mechanical properties are determined:

$R_e$ , [MPa];  $R_p$  ( $R_{p\ 0.2\ to\ 1.0}$ ), [MPa];  $R_m$ , [MPa];  $A$  ( $A$ ,  $A_{11.3}$ ,  $A_{50\ mm}$ ,  $A_{200\ mm}$ ), [%] and  $Z$ , [%].

Unless provided otherwise, tensile test shall be performed at ambient temperature.

At tensile tests of metals at elevated temperature, the determined values shall be supplemented with index stating the temperature of testing, in °C (e.g.  $R_m^{350}$ ,  $R_e^{400}$ ,  $A^{200}$ ,  $Z^{300}$ ).

**2.5.2** The test intended to determine the yield point,  $R_e$ , shall be performed with an elastic stress within the limits specified in Table 2.5.2.

For austenitic and austenitic-ferritic (duplex) stainless steel products, the 1% proof stress ( $R_{p1.0}$ ) may be determined in addition to  $R_{p0.2}$  or to the physical yield point  $R_e$ .

After reaching the yield or proof load for ductile materials, the machine speed during the tensile test shall not exceed that corresponding to a strain rate of  $0.008 \text{ s}^{-1}$ . For brittle materials, such as cast iron, the elastic stress rate shall not exceed  $10 \text{ MPa} \cdot \text{s}^{-1}$ .

**Table 2.5.2**

Modulus of elasticity of the material, $E$ [MPa]	Rate of stressing [ $\text{MPa} \cdot \text{s}^{-1}$ ]	
	min	max
< 150 000	2	20
$\geq 150 000$	6	60

**2.5.3** For tensile test, the specimens having the shape and dimensions as shown in figures 2.5.3-1 to 2.5.3-4 and in Table 2.5.3 shall be used. Permissible dimensional deviations and tolerance of form of the specimens shall fulfil the requirements of standard ISO 6892-1:2019, ISO 6892-2:2018 or other recognized standards as appropriate.

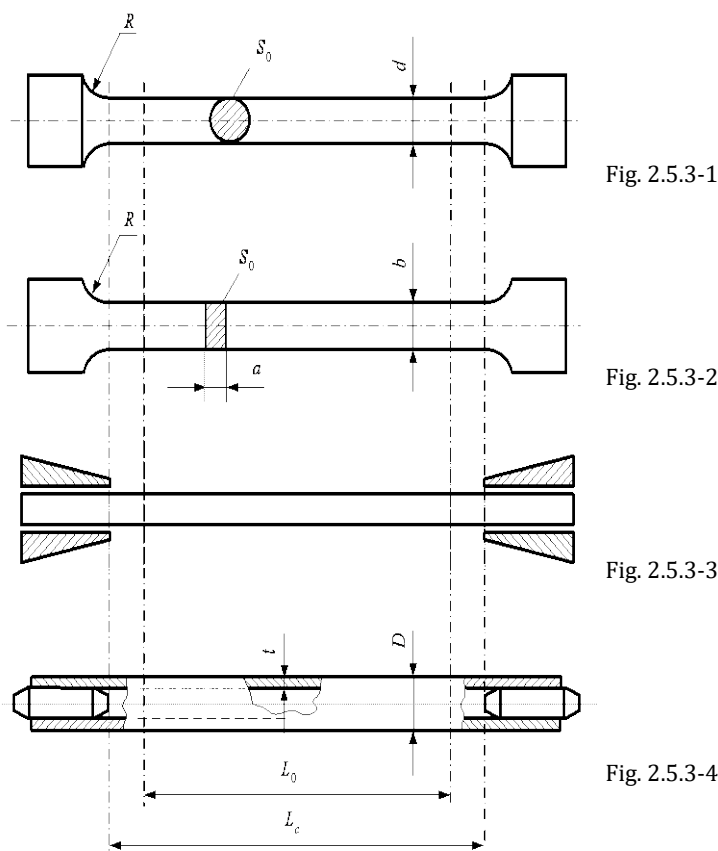

Explanation of symbols used in the figures and Table 2.5.3:

- $d$  – diameter of specimen, [mm];
- $a$  – thickness of specimen, [mm];

- $b$  – width of specimen, [mm];
- $L_c$  – parallel test length, [mm];
- $L_0$  – original gauge length, [mm];
- $R$  – transition radius, [mm];
- $S_0$  – original cross sectional area of specimen, [mm<sup>2</sup>];
- $D$  – external diameter of tube, [mm];
- $t$  – thickness of product (wall), [mm].

Proportional test specimens shall be of a round or rectangular cross-section and shall have a gauge length  $L_0 = 5 d$  or  $L_0 = 5.65 \sqrt{S_0}$ , respectively ( $L_0$  shall, however, be greater than 20 mm). Basic dimensions of tensile test specimens depending on their type are specified in Table 2.5.3.

**Table 2.5.3**

Item	Name of product	Type and dimensions of specimen
1	Forgings, castings (except grey iron castings)	1. Round specimen (Fig. 2.5.3-1): $d = 10 \div 20$ mm (preferably $d = 14$ mm); $L_0 = 5 d$ ; $L_c \geq L_0 + d/2$ ; $R = 10$ mm ( $R \geq 1.5 d$ for materials with $A \leq 10\%$ and for nodular cast iron)
2	Plates, strips and sections	1. Flat specimen (Fig. 2.5.3-2): $a = t$ ; $b = 25$ mm; $L_0 = 5.65 \sqrt{S_0}$ ; $L_c \geq L_0 + 2 \sqrt{S_0}$ ; $R = 25$ mm (Note: If the capacity of the available testing machine does not allow the use of flat specimens of full thickness $t$ , the thickness may be reduced by machining one side only). 2. Non-proportional flat specimen (Fig. 2.5.3-2): $a = t$ ; $b = 25$ mm; $L_0 = 200$ mm; $L_c \geq 212.5$ mm; $R = 25$ mm 3. Proportional round specimen of dimensions as in item 1, located with its centre $1/4 t$ from product surface or as close to this position as possible (applies to products of $t \geq 40$ mm) and with its longitudinal axis perpendicular to product surface.
3	Tubes	1. Full cross-section tensile test specimen (Fig. 2.5.3-4): $L_0 = 5.65 \sqrt{S_0}$ ; $L_c \geq 5.65 \sqrt{S_0} + D/2$ ; ( $L_c$ is the distance between the grips or the plugs, whichever is smaller) 2. Strips cut longitudinally from full thickness wall (Fig. 2.5.3-2): $a = t$ ; $b \geq 12$ mm; $L_0 = 5.65 \sqrt{S_0}$ ; $L_c \geq L_0 + 2b$ ; $R = 10$ mm The parallel test length is not flattened, but the enlarged ends may be flattened for gripping in the testing machine. 3. Proportional round specimen (Fig. 2.5.3-1): as for item 1 (Round test specimens may also be used provided that the wall thickness is sufficient to allow for machining of such specimens to the dimensions given in Fig. 2.5.3-1 with their axes situated at the midwall thickness).
4	Wires and rods with diameter equal or less than 4 mm	Not machine-treated full cross-section tensile test specimen (Fig. 2.5.3-3): $L_0 = 200$ mm; $L_c \geq L_0 + 50$ mm
5	Wires and rods with diameter more than 4 mm	Proportional round specimen (Fig. 2.5.3-1): $d = 5 \div 20$ mm; $L_0 = 5 d$ ; $L_c \geq L_0 + d/2$

The elongation value is valid only if the distance between the fracture and the nearest gauge mark is not less than one third of the original gauge length. The result, however, is valid irrespective of the location of the fracture if the percentage elongation after fracture is equal to or greater than the required value.

The elongation value after fracture shall be determined on proportional specimens. In justified cases, PRS may agree that the mechanical properties of materials be determined on specimens other than the proportional ones.

For non-proportional specimens from non-alloyed and alloy steels not subjected to cold plastic working, the elongation value after fracture shall not be less than that determined in accordance with the formula below:

$$A_0 = 2A \left( \frac{\sqrt{S_0}}{L_0} \right)^{0.4} \quad [\%] \quad (2.5.3)$$

**2.5.4** To determine the tensile strength of grey cast iron, the specimen of a round cross-section, as shown in Fig. 2.5.4, shall be used.

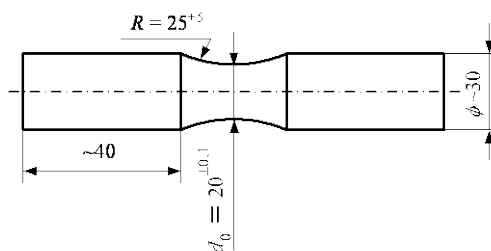

Fig. 2.5.4

**2.5.5** For testing of aluminium alloys, flat tensile test specimens shall be used for specified thicknesses not exceeding 12.5 mm. For thicknesses  $t > 12.5$  mm, round tensile test specimens shall be used. For thicknesses not exceeding 40 mm, the longitudinal axis of the round tensile test specimen shall be located at a distance from the surface equal to half of the thickness of the tested material item. For thicknesses over 40 mm, the longitudinal axis of the round tensile test specimen shall be located at a distance from one of the surfaces equal to one quarter of the thickness of the tested material item.

**2.5.6** To determine the butt weld tensile strength, a flat specimen with the weld machined (or ground) flush with the surface of the plate, shall be used. The dimensions of the specimen shall be in accordance with Fig. 2.5.6:

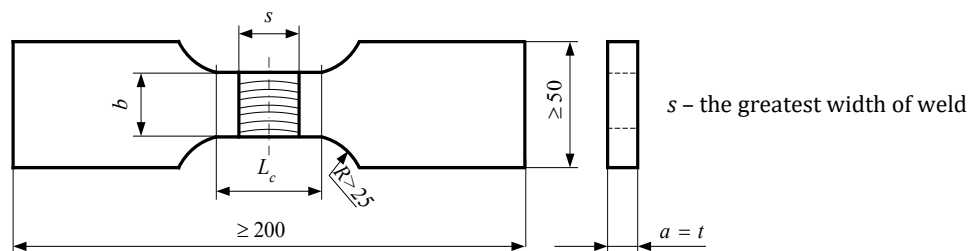

Fig. 2.5.6

- $a = t$
- $b = 12 \text{ mm}$  for  $t \leq 2 \text{ mm}$
- $b = 25 \text{ mm}$  for  $t > 2 \text{ mm}$
- $L_c = s + 60 \text{ mm}$
- $R > 25 \text{ mm}$ .

**2.5.7** To determine the deposited metal tensile strength, a round specimen with the following dimensions shall be used:

- $d = 10 \pm 0.075 \text{ mm}$
- $L_0 = 50 \pm 0.5 \text{ mm}$
- $L_c \geq 55 \text{ mm}$
- $R \geq 10 \text{ mm}$ .

For specially small or large dimensions, other specimens may be used after PRS approval provided they conform to the geometrical relationship specified in Table 2.5.3 item 1.

## 2.6 Impact Test

**2.6.1** Impact value  $KV$ ,  $[J]$ , shall be determined on the ISO Charpy V-notch specimens. The test specimens shall be machined to the dimensions and tolerances given in Fig. 2.6.1 and Table 2.6.1-1.

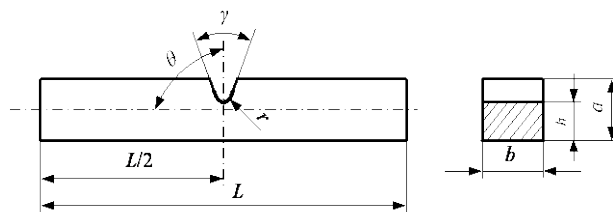

Fig. 2.6.1

Dimensions of impact test specimens are given in Table 2.6.1-1.

V-notch specimens with a width of 7.5 and 5 mm shall be used only for these products from which test specimens with a width of 10 mm cannot be prepared. The impact test values obtained on such specimens shall fulfil the requirements specified in Table 2.6.1-2.

**Table 2.6.1-1**  
**Dimensions of impact test specimens**

Dimension	Nominal	Tolerance
$L$	55 mm	$\pm 0.60$ mm
$L/2$	27.5 mm	$\pm 0.42$ mm
$a$	10 mm	$\pm 0.06$ mm
$b$	10 mm	$\pm 0.11$ mm
	7.5 mm	$\pm 0.11$ mm
	5 mm	$\pm 0.06$ mm
$h$	8 mm	$\pm 0.06$ mm
$r$	0.25 mm	$\pm 0.025$ mm
$\gamma$	45°	$\pm 2^\circ$
$\theta$	90°	$\pm 2^\circ$

**Table 2.6.1-2**

Dimensions of specimen [mm]	Average impact value, $KV$ <sup>1)</sup> [J]
10 × 10 × 55	$KV$
10 × 7.5 × 55	5/6 $KV$
10 × 5 × 55	2/3 $KV$

<sup>1)</sup>  $KV$  – required impact value specified in the relevant Chapters of this *Part* of the *Rules*.

On specimens taken from plates, flats and sections, the notch shall be perpendicular to the external surface of the product, with at least one surface in rough condition.

Impact value  $KV$  shall be determined on three specimens. One of the obtained values may be lower than the required one, but by not more than by 30 per cent.



**2.6.2** Impact test shall be performed on the Charpy pendulum impact testing machine with an initial striking energy of 300 or 150 J.

The distance between the hammer supports shall be  $40 \pm 5$  mm. The point of impact of the hammer shall be in plane of symmetry of the specimen notch, from its opposite side, the distance between the planes of symmetry of the notch and the cutter not exceeding 0.5 mm.

Where the impact test is performed at a lower temperature, the test specimens shall be kept in the cooling medium for at least 15 minutes from the moment the temperature of the medium has become steady. At the test temperature down to  $-60^{\circ}\text{C}$ , the value of over-cooling may be reduced to  $-4^{\circ}\text{C}$ ; at the moment of specimen fracture, the temperature shall not vary from the prescribed test temperature by more than  $\pm 2^{\circ}\text{C}$ .

**2.6.3** Impact tests may be performed (according to the definitions adopted in standard PN-EN ISO 3785) on longitudinal specimens (L) or transverse specimens (T). Longitudinal specimens are taken parallel with the longitudinal axis of a rolled or extruded product (along the grain flow pattern). Transverse specimens are taken perpendicular to the longitudinal and Z axes (axis Z is parallel with the direction of main force causing the material strain).

**2.6.4** Where hull structural steel ageing resistance shall be determined (the ageing conditions – 5% strain and annealing at a temperature of  $250 \pm 2^{\circ}\text{C}$  for 1 hour), the test conditions and requirements are subject to PRS acceptance in each particular case.

## 2.7 Bend Test

**2.7.1** Flat bend test specimen shall be made in accordance with Fig. 2.7.1. Tension side edges shall be rounded to a radius of  $1 \div 2$  mm.

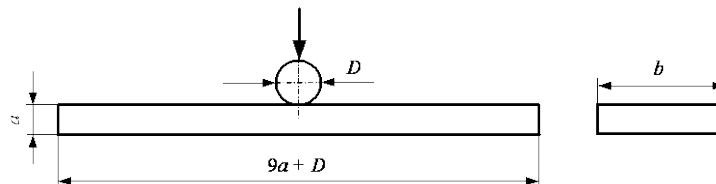

Fig. 2.7.1

Particulars of the testing conditions are specified in standard PN-EN ISO 7438. Unless specified in the particular chapters of *Part IX*, the former diameter and the angle of bending the specimen shall be selected in accordance with the relevant standards.

**2.7.2** Bend tests of castings, forgings and similar products shall be performed on specimens with the following cross-section dimensions:

$$a = 20 \text{ mm}; \quad b = 25 \text{ mm.}$$

**2.7.3** Bend tests of plates, structural sections and strips shall be performed on specimens with the following cross-section dimensions:

$$a = t; \quad b = 30 \text{ mm.}$$

If product thickness  $t$  is greater than 25 mm, it may be reduced to 25 mm by machining on one side.

In that case, the former shall be placed on the machined face when testing.

**2.7.4** Bend tests of butt welds shall be performed on specimens with the following cross-section dimensions:

$$a = t; \quad b = 30 \text{ mm.}$$

For bend tests of welded joints, one part of the specimens shall be tested with the weld face in tension and the other with the weld root in tension. The weld shall be machined (or ground) flush with the surface of the plate. If product thickness  $t$  is greater than 25 mm, it may be reduced to 25 mm by machining on one side. In that case, the former shall be placed on the machined face when testing.

**2.7.5** Side bend tests of butt welds shall be performed on specimens with the following cross-section dimensions:

$$a = 10 \text{ mm}; \quad b = t.$$

Where thickness of butt welds  $t \geq 40$  mm, a side bend test specimen may be so split into parts of a width  $b \geq 20$  mm that the entire weld thickness is covered.

**2.7.6** Test specimens for longitudinal face and root test shall be made in accordance with standard PN-EN ISO 5173. One part of the specimens shall be tested with the weld face in tension and the other with the weld root in tension.

## 2.8 Pellini Dropweight Test (DWT)

Pellini dropweight test shall be performed in accordance with standard ASTM E208:2019. The dimensions (in mm) of test specimens shall be as follows:

Type P-1	25 × 90 × 360,
Type P-2	19 × 50 × 130 or
Type P-3	16 × 50 × 130.

For flame-cut specimens, their dimensions shall be increased by 25 mm, however not less than the plate thickness.

Machining of the plate to prescribed specimen thickness shall be on one side only. Unless otherwise stated in the relevant standards, the specimens may be of any orientation; the orientation, however, shall be the same for all specimens.

## 2.9 Hardness Testing

Hardness shall be determined by Brinell ( $HB$ ), Vickers ( $HV$ ), Rockwell ( $HRC$ ) method or other method subject to PRS acceptance in each particular case. Hardness tests shall be performed in accordance with the relevant standards (PN-EN ISO 6506-1, PN-EN ISO 6507-1, PN-EN ISO 6508-1).

## 2.10 Macroscopic and Microscopic Examinations

If required by the *Rules*, macroscopic and microscopic examinations shall be performed in accordance with the relevant standards (PN-EN ISO 17639, PN-EN ISO 945-1 or equivalent).

## 2.11 Ductility Tests for Pipes and Tubes

### 2.11.1 Flattening Test

Flattening test shall be performed for metallic tubes with an outside diameter  $D$  not exceeding 406.4 mm and wall thickness  $t$  not exceeding  $0.15 D$ .

Specimen length shall be  $L = 1.5 D$ , however the following condition shall be fulfilled:  $10 \text{ mm} \leq L \leq 100 \text{ mm}$ .

Unless otherwise stated in the *Rules* or relevant standards, the tube section shall be flattened until distance  $H$  between the testing machine pressure plates reaches the value:

$$H = \frac{(1+c)t}{c+\frac{t}{D}} \quad [\text{mm}] \quad (2.11.1)$$

- $D$  – outside diameter of tube, [mm];
- $t$  – nominal tube wall thickness, [mm];
- $c$  – factor depending on the material (to be assumed in accordance with the relevant standards or subject to PRS acceptance in each particular case).

Where it is required that the flattening test be performed until the inner surfaces of the tube meet, the distance  $H$  between the testing machine pressure plates shall not exceed  $2.25 t$ .

In the case of flattening test of welded tubes, the specimen shall be so placed in the tensile testing device that the welded seam lies at  $90^\circ$  to the direction of flattening, in the specimen's centreline. The test result is considered satisfactory if the specimen is free from cracks or pulls.

Plain and smoothed ends shall be cut perpendicular to the tube axis. Reference is made to standard ISO 8492:2013.

### 2.11.2 Drift Expanding Test

Drift expanding test shall be performed for tubes with the external diameter up to and including 150 mm and the wall thickness up to 9 mm. A tapered drift shall be forced into the tube until the required expansion degree is reached. Length  $L$  of the drift expanding test specimen shall be equal to twice the outside diameter  $D$  of the tube if the angle of the drift  $\beta$  is  $30^\circ$ , and  $L$  equal to  $1.5D$  if the angle of the drift is  $45^\circ$  or  $60^\circ$ . The test piece may be shorter provided that after testing the remaining cylindrical portion is not less than  $0.5D$ . The rate of penetration of the mandrel shall not exceed 50 mm/min. The test result is considered satisfactory if the test specimen is free from cracks or pulls. Reference is made to standard ISO 8493:1998.

### 2.11.3 Ring Tensile Test

Ring tensile test shall be performed for steel tubes with external diameter  $D$  within the range 110÷510 mm, wall thickness  $t$  not exceeding 30 mm and  $t/D$  ratio not greater than 0.13.

The specimen shall be a tube piece with a length  $\sim 15$  mm. The ring shall be stretched in a tensile testing machine until it breaks using two pins with a diameter equal to at least three times the wall thickness of the tube.

In the case of welded tubes, the specimen shall be so placed in the tensile testing device that the welded seam lies at  $90^\circ$  to the direction of the tensile load, in the specimen's centreline.

The ring shall be drawn with the rate not exceeding 5 mm/s. The ring shall have plain and smoothed ends cut perpendicular to the tube ends.

The test result is considered satisfactory if the specimen is free from surface defects and reveals no laminations or symptoms of brittleness at the point of fracture.

Reference is made to standard ISO 8496:2013.

### 2.11.4 Flanging Test

Flanging test specimen shall be of length  $L$  equal to approximately  $1.5D$ . The test piece may be shorter provided that after testing the remaining cylindrical portion is not less than  $0.5D$ . The rate of penetration of the forming tool shall not exceed 50 mm/min.

The test result is considered satisfactory if no fracture is visible with an unaided eye. Reference is made to standard ISO 8494:2013.

### 2.11.5 Ring Expanding Test

Ring expanding test specimen shall have a length between 10 to 16 mm. The rate of penetration of the mandrel shall not exceed 30 mm/min. The test consists in uniform and consistent forcing a tapered drift of a taper 1:10 or 1:5 into the specimen until the expansion degree is reached. Reference is made to standard ISO 8495:2013.

The test result is considered satisfactory if no fracture is visible with an unaided eye.

### 2.12 ESSO Test

**2.12.1** The ESSO test is used to estimate the brittle crack arrest toughness value  $K_{ca}$  of rolled hull steel plates of thickness not greater than 100 mm.

**2.12.2** In the current sub-chapter the following symbols are used:

$t_s$  [mm] – thickness of test specimen,

$W_s$  [mm] – width of test specimen,

$L_s$  [mm] – length of test specimen,

$t_r$  [mm] – thickness of tab plate,

$W_r$  [mm] – width of tab plate,

$L_r$  [mm] – length of tab plate,

$L_p$  [mm] – distance between pins,

$a$  [mm] – length of crack projected on surface normal to the line of load,

$a_a$  [mm] – maximum crack length at brittle crack arrest position,

$T$  [°C] – temperature of test specimen,

$dT/da$  [°C/mm] – temperature gradient of test specimen,

$\sigma$  [N/mm<sup>2</sup>] – gross stress in tested part (load /  $W_s t_s$ ),

$K_{ca}$  [N/mm<sup>3/2</sup>] – brittle crack arrest toughness value

**2.12.3** The purpose of this test is to encourage the performance of a standard test for assessment of brittle crack arrest toughness with temperature gradient and to obtain the corresponding brittle crack arrest toughness value  $K_{ca}$ . The conceptual view of test specimen, tab and load jig is shown in Fig. 2.12.3.

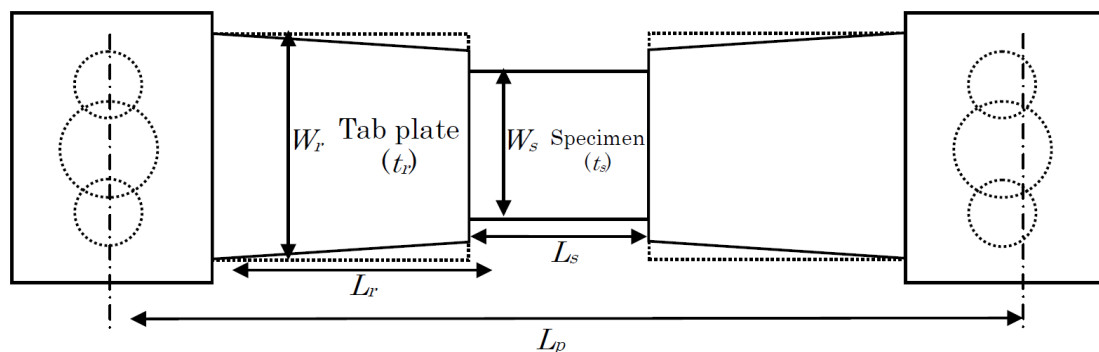

Fig. 2.12.3

**2.12.4** The shape and size of the standard test specimen is shown in Figure 2.12.4. The thickness and width of the test specimen shall be in accordance with Table 2.12.4.

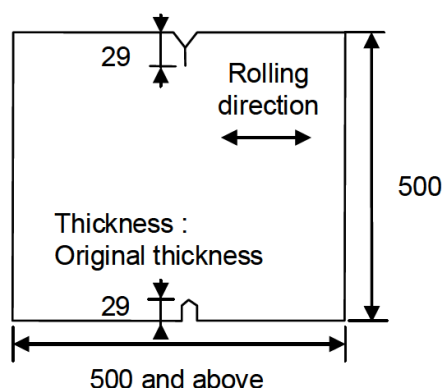

Fig. 2.12.4

**Table 2.12.4**  
**Thickness and width of test specimen**

Thickness $t_s$ [mm]	100 mm and below
Width $W_s$ [mm]	500 mm <sup>1)</sup>

<sup>1)</sup> If the width of the test specimen cannot be made at 500 mm, it may be taken as 600 mm.

The test specimens shall be taken from the same steel plate.

Test specimens shall be taken in such a way that the axial direction of the load is parallel to the rolling direction of the steel plate.

The thickness of the test specimen shall be the same as the thickness of the steel plate to be used in the ship structure.

**2.12.5** The test equipment to be used shall consist of pin load type hydraulic test equipment capable of tensile tests.

The distance between the pins shall be not less than 2000 mm. The distance between pins refers to the distance between the centres of the pin diameters.

Drop weight type or air gun type impact equipment may be used for the impact energy required for generating brittle cracks.

The wedge shall have an angle greater than the upper notch of the test specimen and an opening force shall be applied on the notch.

**2.12.6** The test piece shall be fixed directly to the pin load jig or by means of weld joint through the tab plate. The overall length of the test specimen and tab plate shall be not less than  $3W_s$ . The thickness and width of the tab plate shall be in accordance with Table 2.12.6.

**Table 2.12.6**  
**Allowable dimensions of tab plate**

Thickness $t_r$ [mm]	$0.8t_s \leq t_r \leq 1.5t_s$
Width $W_r$ [mm]	$W_s^{1)} \leq W_r \leq 2W_s$

<sup>1)</sup> If the tab plate has a thickness smaller than the test specimen, the reflection of stress wave will be on the safer side for the assessment; therefore, considering the actual circumstances for conducting the test, the lower limit of thickness is taken as  $0.8t_s$ .

Thermocouples shall be fitted at 50 mm pitch on the notch extension line of the test specimen.

If the brittle crack is estimated to deviate from its presumed course, thermocouples shall be fitted at two points separately by 100 mm on the line of load from the notch extension line at the centre of width of the test specimen.

If dynamic measurements are necessary, strain gauges and crack gauges shall be fitted at specific locations.

The test specimen shall be fixed to the testing machine together with the tab plate after welding and the pin load jig.

The impact equipment shall be mounted. The construction of the impact equipment shall be such that the impact energy is correctly transmitted. An appropriate jig shall be arranged to minimize the effect of bending load due to the impact equipment.

**2.12.7** To eliminate the effect of residual stress or correct the angular deformation of tab welding, a preload less than the test load may be applied before cooling.

Cooling and heating may be implemented from one side on the side opposite the side on which the thermocouple is fitted, or from both sides.

The temperature gradient shall be controlled in the range of 0.25°C/mm to 0.35°C/mm in the range of width from 0.3 $W_s$  to 0.7 $W_s$  at the central part of the specimen.

When the specific temperature gradient is reached, the temperature shall be maintained for more than 10 minutes, after which the specified test load may then be applied.

After maintaining the test load for at least 30 seconds, a brittle crack shall be generated by impact.

The standard impact energy is taken as 20 to 60 J per 1 mm plate thickness. If the brittle crack initiation characteristics of the base metal are high, and it is difficult to generate a brittle crack, the impact energy may be increased to the upper limit of 120 J per 1 mm plate thickness.

Loading is stopped when the initiation, propagation, and arrest of crack have been confirmed. Normal temperature is restored, and if necessary, the ligament is broken by gas cutting and forcibly the specimen is broken by using the testing machine. Or, after the ductile crack has been propagated to an adequate length with the testing machine, the ligament is broken by gas cutting.

After forcing the fracture, photos of the fractured surface and the propagation route shall be taken, and the crack length shall be measured.

**2.12.8** The distance from the top of the test specimen including the notch to the maximum length in the plate thickness direction of the arrested crack tip shall be measured. If the crack surface deviates from the surface normal to the line of load of the test specimen, the projected length of the surface normal to the line of load shall be measured. In this case, if the trace of brittle crack arrest is clearly visible on the fractured surface, the first crack arrest position is taken as the arrest crack position.

From the results of thermocouple measurements, the temperature distribution curve shall be plotted, and the arrest crack temperature shall be measured corresponding to the arrest crack length.

The brittle crack arrest toughness value  $K_{ca}$  of each test shall be determined by using the following formula:

$$K_{ca} = \sigma \sqrt{\pi a} \sqrt{\frac{2W_s}{\pi a} \tan \frac{\pi a}{2W_s}}$$

**2.12.9** The following items shall be reported:

- .1 Testing machine specifications, testing machine capacity, distance between pins ( $L_p$ ),
- .2 Load jig dimensions: tab plate thickness ( $t_r$ ), tab plate width ( $W_r$ ), test specimen length including tab plate ( $L_s+2L_r$ ),
- .3 Test specimen dimensions: plate thickness ( $t_s$ ), test specimen width ( $W_s$ ) and length ( $L_s$ ),
- .4 Test conditions: preload stress, test stress, temperature distribution (figure or table), impact energy,
- .5 Test results: crack arrest length ( $aa$ ), temperature gradient at arrest position, brittle crack arrest toughness ( $K_{ca}$ ),
- .6 Dynamic measurements results (if measurement is performed): crack growth rate, strain change,
- .7 Test specimen photos: fracture route, fractured surface.

If the conditions below are not satisfied, the test results shall be treated as reference values:

- .1 The brittle crack arrest position shall be in the range of the hatched part shown in Fig. 2.12.9. In this case, if the brittle crack arrest position is more than 50 mm away from the centre of the test specimen in the longitudinal direction of the test specimen, the temperature of the thermocouple at the  $\pm 100$  mm position is to be within  $\pm 3^\circ\text{C}$  of the thermocouple at the centre.
- .2 The brittle crack should not have a distinct crack bifurcation while it propagates.

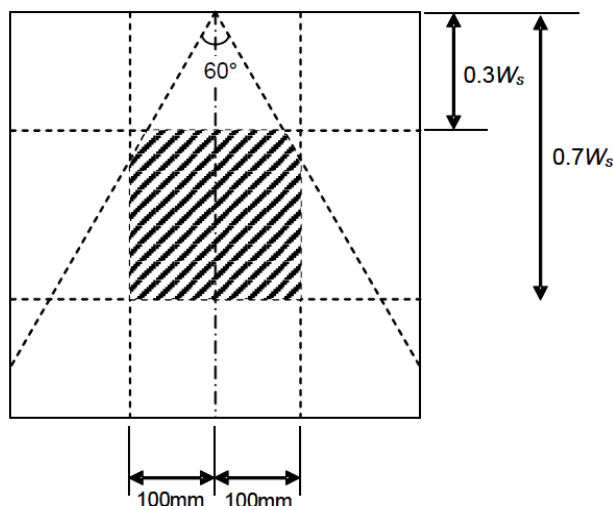

Fig. 2.12.9

From effective test results measured at more than 3 points, the linear approximation equation shall be determined on the Arrhenius plot, and  $K_{ca}$  at the desired temperature shall be calculated. In this case, data should exist on both sides, that is, the high temperature and low temperature sides around the assessed temperature.

## 2.13 Weldability Test

**2.13.1** The requirements specified in this sub-chapter apply to testing weldability of the materials submitted for approval. PRS reserves the right to increase or reduce the scope of testing.

Weldability tests shall be performed for rolled steel, cast steel, forged steel and aluminium alloys if they are intended for welded hull structures. The tests shall be performed under PRS direct survey.

**2.13.2** Weldability test of material shall be performed using the same welding methods which shall be applied in welded structures that are subject to PRS survey.

**2.13.3** Steel weldability test shall determine:

- .1 chemical composition and mechanical properties of parent metal;
- .2 welded joint susceptibility to cold cracking;
- .3 parent metal resistance to ageing in accordance with paragraph 2.6.4;
- .4 welded joint mechanical properties.

**2.13.4** Weldability test specified in paragraph 2.12.3 shall be performed on test assemblies selected from products of the maximum thickness, from at least two casts.

**2.13.5** Weldability test of metallic materials other than steel shall be performed in accordance with the test programme which is subject to PRS acceptance in each particular case.

## **2.14 Non-Destructive Testing**

**2.14.1** Unless otherwise specified in other *Parts* of the *Rules*, non-destructive testing of materials and welded joints shall be performed in accordance with the requirements specified in *Publication 80/P – Non-destructive Testing*.

**2.14.2** Testing of steel forgings intended for hull structures shall be performed in accordance with the requirements specified in *Publication 70/P – Non-destructive Testing of Hull and Machinery Steel Forgings*.

**2.14.3** Testing of steel castings intended for hull structures shall be performed in accordance with the requirements specified in *Publication 71/P – Non-destructive Testing of Hull Marine Steel Castings*.

## **2.15 Other Tests**

For some other products, other tests than those mentioned in sub-chapters 2.4 to 2.14 may be required. In such cases, testing procedures are subject to PRS acceptance in each particular case.



## **MATERIALS**

### 3 NORMAL AND HIGHER STRENGTH HULL STRUCTURAL STEEL

#### 3.1 Scope of Application

**3.1.1** The requirements, set forth in the present Chapter, apply to weldable normal and higher strength hot-rolled steel plates<sup>1)</sup>, sections and bars intended to be used in hull construction.

**3.1.2** The requirements given below apply to steel products with the thickness as follows:

- for steel plates and wide flats of all grades: up to 100 mm in thickness,
- for sections and bars of all grades: up to 50 mm in thickness.

For greater thickness, the requirements are subject to PRS acceptance in each particular case.

**3.1.3** Provision is made for four grades of normal steel grades (A, B, D, E) based on the impact test requirements. For higher strength steels provision is made for three yield strength levels (315, 355 and 390 MPa), each subdivided into four forms of toughness (A, D, E, F), based on the impact test temperature.

**3.1.4** Additional requirements for normal and higher strength corrosion resistant steel plates, sections and bars up to a maximum thickness of 50 mm used as the alternative means of corrosion protection for cargo oil tanks of oil tankers according to IMO Resolution MSC.289(87) are specified in sub-chapter 3.15.

**3.1.5** Steels differing in chemical composition, deoxidation practice, supply conditions or mechanical properties may be accepted subject to PRS acceptance in each particular case. Such steels shall be given a special designation: e.g. mark "S" may be added to the grade symbol.

**3.1.6** Fatigue resistant hull steels according to IACS Recommendation No. 139 shall be given a special designation added to the grade symbol "FR", e.g. AH36-FR.

**3.1.7** Additional requirements for YP47 steels and brittle crack arrest steels intended for use in container ships are specified in 3.16.

#### 3.2 Approval of Manufacturer

**3.2.1** Hull steels of the particular grade shall be manufactured at works which have been approved by PRS (see sub-chapter 1.5 of this *Part*). Suitability of each grade of steel for forming and welding shall be demonstrated during the initial tests at the steelworks. Approval of the steel works shall follow a scheme specified in *Appendix A* (see the Chapter Appendixes). For steels intended for high heat input welding over 50 kJ/cm, the approval of the manufacturer shall follow a scheme specified in *Appendix B* (see the Chapter Appendixes). The procedure of approval of manufacturer of corrosion resistant steels defined in 3.1.4 shall be supplemented by the requirements given in Appendix C. The procedure of approval of manufacturer of UR S33 steels shall follow the scheme specified in *Appendix F*. The procedure of approval of manufacturer of brittle crack arrest steels shall follow the scheme specified in *Appendix G*. For hull steels with improved fatigue properties called fatigue resistant steels, approval procedure shall be covered according to the requirements of IACS (Recommendation No. 139).

**3.2.2** It is the manufacturer's responsibility to assure that effective process and production controls in operation are adhered to within the manufacturing specifications. Where control imperfection inducing possible inferior quality of product occurs, the manufacturer shall identify

---

<sup>1)</sup> The word "plate" used in this Chapter covers plates and wide flats of width 600 mm or greater (universal plates).

the cause and establish a countermeasure to prevent its recurrence. Also, the complete investigation report shall be submitted to PRS. Frequency of testing for subsequent products offered may be increased to gain confidence in the quality.

**3.2.3** When steel is not produced at the works at which it is rolled, an *Approval Certificate* shall be supplied to PRS Surveyor at the rolling mill stating the process by which it was manufactured, the name of the manufacturer who supplied it, the number of the cast from which it was made and the chemical composition.

**3.3 Methods of Manufacture**

**3.3.1** Steel shall be manufactured by the basic oxygen, electric furnace or open hearth processes or by other processes approved by PRS.

**3.3.2** Deoxidation practice used for each grade shall fulfil the relevant requirements specified in Table 3.4.1-1 and Table 3.4.1-2.

**3.3.3** The rolling practice applied for each grade shall fulfil the appropriate condition of supply specified in Table 3.5-1 and Table 3.5-2. Schematic diagrams of applicable conventional and thermo-mechanical processes are shown in Table 3.3.3.

**Table 3.3.3**  
**Schematic diagrams of thermo-mechanical and conventional processes**

Structure	Temperature	Type of processing					
		Conventional processes				Thermo-mechanical processes	
		AR	N	CR (NR)	QT	TM	
Recrystallised austenite	Normal slab heating temperature						
Non-recrystallised austenite	Normalising or quenching temperature						
Austenite + ferrite	$A_{r3}$ or $A_{c3}$						
Ferrite + pearlite or (ferrite + bainite)	$A_{r1}$ or $A_{c1}$						
	Tempering temperature						

□ – start rolling temperature  
 ■ – delays to allow cooling before finishing rolling process

**Notes:**

AR – As Rolled, N – Normalising, CR (NR) – Controlled Rolling (Normalising Rolling), QT – Quenching and Tempering, TM – Thermo-Mechanical Rolling (Thermo-Mechanical Controlled Process), R – Reduction, (\*) – Sometimes rolling in the dual-phase temperature region of austenite and ferrite), AcC – Accelerated Cooling.

Description of applicable rolling processes are given as follows:

**.1 As Rolled (AR)**

This procedure involves steel being cooled as it is rolled with no further heat treatment. The rolling and finishing temperatures are typically in the austenite recrystallization region and above the normalising temperature. The strength and toughness properties of steel produced by this process are generally less than steel heat treated after rolling or than steel produced by advanced processes.

**.2 Normalising (N)**

Normalising involves heating rolled steel above the critical temperature,  $A_{c3}$ , and in the lower end of the austenite recrystallization region of a specific period of time, followed by air cooling. The process improves the mechanical properties of as rolled steel by refining the grain size and homogenising the microstructure.

**.3 Controlled Rolling (CR), Normalizing Rolling (NR)**

A rolling procedure in which the final deformation is carried out in the normalising temperature range, allowed to cool in air, resulting in a material condition generally equivalent to that obtained by normalising.

**.4 Quenching and Tempering (QT)**

Quenching involves a heat treatment process in which steel is heated to an appropriate temperature above the  $A_{c3}$ , held for a specific period of time, and then cooled with an appropriate coolant for the purpose of hardening the microstructure. Tempering subsequent to quenching is a process in which the steel is reheated to an appropriate temperature not higher than the  $A_{c1}$ , maintained at that temperature for a specific period of time to restore toughness properties by improving the microstructure and reduce the residual stress caused by the quenching process.

**.5 Thermo-mechanical Rolling (TM), Thermo-Mechanical Controlled Processing (TMCP)**

This is a procedure which involves the strict control of both the steel temperature and the rolling reduction. Generally a high proportion of the rolling reduction is carried out close to the  $A_{r3}$  temperature and may involve the rolling in the dual phase temperature region. Unlike controlled rolled (normalised rolling) the properties conferred by TM (TMCP) cannot be reproduced by subsequent normalising or other heat treatment.

The use of accelerated cooling on completion of TM-rolling may also be accepted subject to the special approval of PRS. The same applies for the use of tempering after completion of TM-rolling.

**.6 Accelerated Cooling (AcC)**

Accelerated cooling is a process, which aims to improve mechanical properties by controlled cooling with rates higher than air cooling immediately after the final TM-rolling operation. Direct quenching is excluded from accelerated cooling.

The material properties conferred by TM and AcC cannot be reproduced by subsequent normalising or other heat treatment.

Where NR (CR) and TM with/without AcC are applied, the programmed rolling schedules shall be verified by PRS at the time of the manufacturer approval, and shall be made available when required by the Surveyor. On the manufacturer's responsibility, the programmed rolling schedules shall be adhered to during the rolling operation, as required in 3.2.2. To this effect, the actual rolling records shall be reviewed by the manufacturer and occasionally by the Surveyor.

When deviation from the programmed rolling schedules or normalizing or quenching and tempering procedures occurs, the manufacturer shall take further measures required in 3.2.2 to the Surveyor’s satisfaction.

### 3.4 Chemical Composition

**3.4.1** Chemical composition of samples taken from each ladle of each cast shall be determined by the manufacturer and shall fulfil the appropriate requirements specified in Table 3.4.1-1 and Table 3.4.1-2. For steel plates of thickness exceeding 50 mm, any deviations from the chemical composition specified in Table 3.4.1-1 are subject to PRS acceptance in each particular case.

**Table 3.4.1-1  
Chemical composition and deoxidation practice for normal strength hull steels**

Steel grade	A	B	D	E
Deoxidation practice	For $t \leq 50$ mm: any method except rimmed steel. <sup>1)</sup> For $t > 50$ mm: killed.	For $t \leq 50$ mm: any method except rimmed steel. For $t > 50$ mm: killed.	For $t \leq 25$ mm: killed. For $t > 25$ mm: killed and fine grain treated.	Killed and fine grain treated
Chemical composition [%] (ladle samples) <sup>4), 7), 8)</sup>	Carbon equivalent, $CEV = C + \frac{Mn}{6} \leq 0.40\%$			(3.4.1-1)
C max	0.21 <sup>2)</sup>	0.21	0.21	0.18
Mn min.	$2.5 \times C$	0.80 <sup>3)</sup>	0.60	0.70
Si max	0.50	0.35	0.35	0.35
P max	0.035	0.035	0.035	0.035
S max	0.035	0.035	0.035	0.035
Al (acid soluble) min.	–	–	0.015 <sup>5), 6)</sup>	0.015 <sup>6)</sup>

$t$  – product thickness

**Notes:**

- 1) Grade A sections of up to 12.5 mm in thickness may be accepted in rimmed steel subject to PRS acceptance in each particular case.
- 2) Sections may be made from steel with the carbon content  $C_{max} = 0.23\%$ .
- 3) Where Grade B steel is impact tested, the minimum manganese content may be reduced to 0.60%.
- 4) Where any grade of steel is supplied in the thermo-mechanically rolled (TM) condition, variations in the specified chemical composition may be permitted by PRS.
- 5) For Grade D steel over 25 mm in thickness.
- 6) For Grade D steel over 25 mm in thickness and Grade E steel, the total aluminium content may be determined instead of acid soluble content. In such case, the total aluminium content shall not be less than 0.020%. Other suitable grain refining elements may be used subject to PRS acceptance in each particular case.
- 7) PRS may limit the amount of residual elements which may have an adverse effect on the steel properties, e.g. copper and tin.
- 8) Where additions of any other element have been made as part of the steelmaking practice, the content shall be indicated on the *Inspection Certificate*.

**Table 3.4.1-2**  
**Chemical composition and deoxidation practice for higher strength hull steels**

Steel grade <sup>1)</sup>	AH32	DH32	EH32	FH32
	AH36	DH36	EH36	FH36
	AH40	DH40	EH40	FH40
Deoxidation practice	Killed and fine grain treated			
Chemical composition, [%] (ladle samples) <sup>5), 7)</sup>				
C max	0.18			0.16
Mn	0.90÷1.60 <sup>2)</sup>			0.90÷1.60
Si max	0.50			0.50
P max	0.035			0.025
S max	0.035			0.025
Al (acid soluble) min.	0.015 <sup>3), 4)</sup>			0.015 <sup>3), 4)</sup>
Nb	0.02÷0.05 <sup>4)</sup>	} total		0,02÷0.05 <sup>4)</sup>
V	0.05÷0.10 <sup>4)</sup>	} not more		0.05÷0.10 <sup>4)</sup>
Ti max	0.02	} than 0.12%		0.02
Cu max	0.35			0.35
Cr max	0.20			0.20
Ni max	0.40			0.80
Mo max	0.08			0.08
N max	-			0.009 (0.012 if Al is present)
Carbon equivalent CEV <sup>6)</sup>				

**Notes:**

- 1) Letter "H" is added to the grade mark.
- 2) In products up to 12.5 mm in thickness, the minimum manganese content may be reduced to 0.70%.
- 3) Total aluminium content may be determined instead of the acid soluble content. In that case, the total aluminium content shall not be less than 0.020%.
- 4) The steel shall contain aluminium, niobium, vanadium or other suitable grain refining elements, either singly or in any combination. When used singly, the steel shall contain the minimum content of the grain refining element, specified in the above Table. When used in combination, the minimum content of the grain refining element, specified in the Table, is not applicable.
- 5) Where any grade of higher strength steel is supplied in the thermo-mechanically rolled (TM) condition, variations in the specified chemical composition may be permitted by PRS.
- 6) Where required, the carbon equivalent value CEV shall be calculated from the ladle analysis in accordance with the following formula:

$$CEV = C + \frac{Mn}{6} + \frac{Cr+Mo+V}{5} + \frac{Ni+Cu}{15} \quad [\%] \quad (3.4.1-2)$$

This formula is applicable only to steels which are basically of the carbon-manganese type and gives a general indication of the steel weldability.

- 7) Where additions of any other element have been made as part of the steelmaking practice, the content shall be indicated in the *Inspection Certificate*.

**3.4.2** The manufacturer's chemical composition analysis may be subject to check if deemed necessary by PRS Surveyor.

**3.4.3** For TM steels, the carbon equivalent calculated in accordance with formula 3.4.1-2 shall fulfil the requirements specified in Table 3.4.3.

**Table 3.4.3**  
**Carbon equivalent of higher strength steel up to 100 mm in thickness supplied in TM condition**

Steel grades	Carbon equivalent, CEV max, [%] <sup>1)</sup>	
	$t \leq 50$	$50 < t \leq 100$
AH32, DH32, EH32, FH32	0.36	0.38
AH36, DH36, EH36, FH36	0.38	0.40
AH40, DH40, EH40, FH40	0.40	0.42

$t$  – product thickness, mm.  
<sup>1)</sup> It is a matter for the manufacturer and PRS to mutually agree in individual cases as to whether they wish to specify a more stringent carbon equivalent.

Upon PRS agreement, the following formula ( $P_{cm}$  – cold cracking susceptibility) may be used for evaluating weldability instead of the carbon equivalent CEV:

$$P_{cm} = C + \frac{Si}{30} + \frac{Mn}{20} + \frac{Cu}{20} + \frac{Ni}{60} + \frac{Cr}{20} + \frac{Mo}{15} + \frac{V}{10} + 5B \quad [\%] \quad (3.4.3)$$

In that case,  $P_{cm}$  max. value is subject to PRS acceptance in each particular case (e.g. at approval procedure).

### 3.5 Supply Condition

**3.5.1** All products shall be supplied in condition conformant to the relevant requirements specified in Table 3.5.1-1 and Table 3.5.1-2.

**Table 3.5.1-1**  
**Supply condition of normal strength steels**

Steel grade	Product thickness, $t$ , [mm]	Steel grade
A, B	$t \leq 50$	as rolled, N, CR or TM
	$50 < t \leq 100$	N, CR or TM <sup>1)</sup>
D	$t \leq 35$	as rolled, N, CR or TM
	$35 \leq t \leq 100$	N, CR or TM <sup>2)</sup>
E	$t \leq 100$	N or TM <sup>2)</sup>

<sup>1)</sup> Grades A and B steel plates may be supplied in the as rolled condition subject to PRS acceptance in each particular case.

<sup>2)</sup> Grade D steel sections may be supplied in the as rolled condition, provided satisfactory results are consistently obtained from Charpy V-notch impact tests subject to PRS acceptance in each particular case.

Similarly, Grade E steel sections may be supplied in the as rolled or controlled rolled (CR) condition. The number of impact test specimens shall be in accordance with the requirements specified in sub-chapter 3.11.2 or 3.11.3.

**Table 3.5.1-2**  
**Supply condition of higher strength steels**

Steel grade	Grain refining elements used	Product thickness, $t$ , [mm]	Supply condition
AH32 AH36	Nb and/or V	$t \leq 12.5$	as rolled, N, CR or TM
		$12.5 < t \leq 100$	N, CR or TM <sup>2)</sup>
AH32 AH36	Al or Al + Ti	$t \leq 20$	as rolled, N, CR or TM
		$20 \leq t \leq 35$	N, CR TM or as rolled subject to PRS acceptance in each particular case <sup>1)</sup>
		$35 < t \leq 100$	N, CR or TM <sup>2)</sup>

Steel grade	Grain refining elements used	Product thickness, $t$ , [mm]	Supply condition
AH40	any	$t \leq 12.5$	as rolled, N, CR or TM
		$12.5 < t \leq 50$	N, CR or TM
		$50 < t \leq 100$	N, TM or QT
DH32 DH36	Nb and/or V	$t \leq 12.5$	as rolled, N, CR or TM
		$12.5 < t \leq 100$	N, CR or TM <sup>2)</sup>
DH32 DH36	Al or Al + Ti	$t \leq 20$	as rolled, N, CR or TM
		$20 < t \leq 25$	N, CR TM or as rolled subject to PRS acceptance in each particular case <sup>1)</sup>
		$25 < t \leq 100$	N, CR or TM <sup>2)</sup>
DH40	any	$t \leq 50$	N, CR or TM
		$50 < t \leq 100$	N, TM or QT
EH32 EH36	any	$t \leq 50$	N or TM <sup>2)</sup>
		$50 < t \leq 100$	N or TM
EH40	any	$t \leq 50$	N, TM or QT
		$50 < t \leq 100$	N, TM or QT
FH32 FH36 FH40	any	$t \leq 50$	N, TM or QT <sup>3)</sup>
		$50 < t \leq 100$	N, TM or QT

<sup>1)</sup> The number of impact test specimens shall be in accordance with the requirements specified in sub-chapter 3.11.2.

<sup>2)</sup> Subject to PRS acceptance in each particular case, sections in AH32, AH36, DH32 and DH36 grade steels may be supplied in the as rolled condition, provided satisfactory results are consistently obtained from Charpy V-notch impact tests. Similarly, sections in EH32 and EH36 grade steels may be supplied in the as rolled or controlled rolled (CR) condition. The number of impact test specimens shall be in accordance with the requirements specified in sub-chapter 3.11.2 or 3.11.3.

<sup>3)</sup> Sections in FH32 and FH36 grade steels may be supplied in the as controlled rolled (CR) condition subject to PRS acceptance in each particular case. The number of impact test specimens shall be in accordance with the requirements specified in sub-chapter 3.11.3.

### 3.6 Mechanical Properties

**3.6.1** For tensile test either the upper yield stress  $R_e$  or, where  $R_e$  cannot be determined, the 0.2 percent proof stress  $R_{p0.2}$  shall be determined and the material is considered to fulfil the requirements if either value meets or exceeds the specified minimum value for yield strength  $R_e$ .

**3.6.2** The results of tensile tests for normal strength steels shall fulfil the requirements specified in Table 3.6.2-1, and for higher strength steels – the requirements specified in Table 3.6.2-2.

**Table 3.6.2-1**  
**Mechanical properties of normal strength steels**

Steel grade	Tensile test			Impact test						
	$R_e$ [MPa] min.	$R_m$ [MPa]	$A$ [%] min.	Test temp [°C]	Average impact energy [J] min.					
					$t \leq 50$		$50 < t \leq 70$		$70 < t \leq 100$	
					L <sup>3)</sup>	T <sup>3)</sup>	L <sup>3)</sup>	T <sup>3)</sup>	L <sup>3)</sup>	T <sup>3)</sup>
A	235	400÷520 <sup>1)</sup>	22 <sup>2)</sup>	+20	–	–	34 <sup>5)</sup>	24 <sup>5)</sup>	41 <sup>5)</sup>	27 <sup>5)</sup>
B				0	27 <sup>4)</sup>	20 <sup>4)</sup>	34	24	41	27
D				–20	27	20	34	24	41	27
E				–40	27	20	34	24	41	27



$t$  – product thickness, [mm], L – longitudinal specimen, T – transverse specimen

- 1) For all thicknesses of Grade A sections, the upper limit for the specified tensile strength  $R_m$  range may be exceeded subject to PRS acceptance in each particular case
- 2) Elongation  $A_{200\text{ mm}}$  determined on non-proportional flat specimens, shall fulfil the following requirements:

Product thickness $t$ [mm]	$t \leq 5$	$5 < t \leq 10$	$10 < t \leq 15$	$15 < t \leq 20$	$20 < t \leq 25$	$25 < t \leq 30$	$30 < t \leq 40$	$40 < t \leq 50$
$A_{200\text{ mm}}$ [%] min.	14	16	17	18	19	20	21	22

- 3) See 3.6.3.
- 4) PRS may waive the Charpy V-notch impact tests for Grade B steel with the thickness of 25 mm or less.
- 5) Impact tests for Grade A steel products over 50 mm in thickness are not required when the material is produced using fine grain practice and furnished normalized. TM rolling may be accepted without impact testing subject to PRS acceptance in each particular case.

**Table 3.6.2-2**  
**Mechanical properties of higher strength steels**

Steel grade	Tensile test			Impact test						
	$R_e$ [MPa] min.	$R_m$ [MPa]	$A$ [%] min.	Test temp. [°C]	Average impact energy [J] min.					
					$t \leq 50$		$50 < t \leq 70$		$70 < t \leq 100$	
					L <sup>2)</sup>	T <sup>2)</sup>	L <sup>2)</sup>	T <sup>2)</sup>	L <sup>2)</sup>	T <sup>2)</sup>
AH32 DH32 EH32 FH32	315	440÷570	22 <sup>1)</sup>	0	31 <sup>3)</sup>	22 <sup>3)</sup>	38	26	46	31
-20				31	22	38	26	46	31	
-40				31	22	38	26	46	31	
-60				31	22	38	26	46	31	
AH36 DH36 EH36 FH36	355	490÷630	21 <sup>1)</sup>	0	34 <sup>3)</sup>	24 <sup>3)</sup>	41	27	50	34
-20				34	24	41	27	50	34	
-40				34	24	41	27	50	34	
-60				34	24	41	27	50	34	
AH40 DH40 EH40 FH40	390	510÷660	20 <sup>1)</sup>	0	39	27	46	31	55	37
-20				39	27	46	31	55	37	
-40				39	27	46	31	55	37	
-60				39	27	46	31	55	37	

$t$  – product thickness, [mm], L – longitudinal specimen, T – transverse specimen

- 1) Elongation  $A_{200\text{ mm}}$  determined on non-proportional flat specimens, shall fulfil the following requirements:

Steel grade	Product thickness $t$ [mm]							
	$t \leq 5$	$5 < t \leq 10$	$10 < t \leq 15$	$15 < t \leq 20$	$20 < t \leq 25$	$25 < t \leq 30$	$30 < t \leq 40$	$40 < t \leq 50$
	Elongation $A_{200\text{ mm}}$ [%], min.							
AH32, DH32, EH32, FH32	14	16	17	18	19	20	21	22
AH36, DH36, EH36, FH36	13	15	16	17	18	19	20	21
AH40, DH40, EH40, FH40	12	14	15	16	17	18	19	20

- 2) See 3.6.3.
- 3) For AH32 and AH36 steel grades, a relaxation in the number of impact tests for acceptance purposes may be permitted by PRS acceptance in each particular case, provided that satisfactory results are obtained from occasional check tests.

**3.6.3** The minimum average energy values shall be specified on Charpy V-notch test specimens taken in longitudinal direction ( $KV_L$ ). Transverse test specimens ( $KV_T$ ) may be required by the purchaser or PRS. Transverse test results shall, however, be guaranteed by the supplier.

The tabulated values are for standard specimens 10×10×55 mm. For plate thicknesses less than 10 mm, impact test may be waived subject to PRS acceptance in each particular case or sub-size specimens, as specified in sub-chapter 2.6.1 of this *Part*, may be used.

**3.6.4** The average value obtained from one set of three impact tests shall fulfil the requirements specified in Table 3.6.2-1 and 3.6.2-2. One individual value only may be below the specified average value, provided it is not less than 70% of that value.

**3.6.5** Impact tests are not required when the nominal plate thickness is less than 6 mm.

### **3.7 Surface Quality and Internal Soundness**

**3.7.1** The steel shall be free from surface defects prejudicial to the use of the material for the intended application. The finished material shall have a surface quality in accordance with a recognized standard such as EN 10163 parts 1, 2 and 3, or an equivalent standard accepted by PRS, unless otherwise specified in this section.

**3.7.2** The responsibility for meeting the surface finish requirements rests with the manufacturer of the material, who is to take the necessary manufacturing precautions and is to inspect the products prior to the delivery. At that stage, however, rolling or heat treatment scale may conceal surface discontinuities and defects. If, during the subsequent descaling or working operations, the material is found to be defective, PRS may require materials to be repaired or rejected.

**3.7.3** The surface quality inspection method shall be in accordance with recognized national or international standards agreed between purchaser and manufacturer, accepted by PRS.

**3.7.4** If agreed by the manufacturer and purchaser, steel may be ordered with improved surface finish over and above these requirements.

**3.7.5** If plates and wide flats are ordered with ultrasonic inspection, this shall be made in accordance with an accepted standard at the discretion of PRS.

**3.7.6** Verification of internal soundness is the responsibility of the manufacturer. The acceptance of internal soundness by PRS surveyor shall not absolve the manufacturer from this responsibility.

### **3.7.7 Acceptance Criteria**

#### **3.7.7.1 Imperfections**

Imperfections of a harmless nature, for example pitting, rolled-in scale, indentations, roll marks, scratches and grooves, regarded as being inherent of the manufacturing process, are permissible irrespective of their number, provided the maximum permissible limits of Class A of EN 10163-2 or limits specified in a recognized equivalent standard accepted by PRS, are not exceeded and the remaining plate of wide flat thickness remains within the average allowable minus thickness tolerance specified in 3.8.1. Total affected area with imperfection not exceeding the specified limit shall not exceed 15% of the total surface in question.

#### **3.7.7.2 Defects**

Affected areas with imperfections with a depth exceeding the limits of Class A of EN 10163-2 or the maximum permissible limits specified in a recognized equivalent standard accepted by PRS, shall be repaired irrespective of their number.

Cracks, injurious surface flaws, shells (overlapping material with non-metallic inclusion), sand patches, laminations and sharp edged seams (elongated defects) visually evident on surface and/or edge of plate are considered defects, which would impair the end use of the product and which require rejection or repair, irrespective of their size and number.

### 3.7.7.3 Repair

#### 3.7.7.3.1 Grinding repair

Grinding may be applied provided all the conditions below are adhered to:

- .1 The nominal product thickness will not be reduced by more than 7% or 3 mm, whichever is less;
- .2 Each single ground area does not exceed 0.25 m<sup>2</sup>;
- .3 All ground areas do not exceed 2% of the total surface in question;
- .4 Ground areas lying in a distance less than their average breadth to each other are to be regarded as one single area;
- .5 Ground areas lying opposite each other on both surfaces shall not decrease the product thickness by values exceeding the limits as stated under .1.

Defects or unacceptable imperfections are to be completely removed by grinding and the remaining plate or wide flat thickness shall remain within the average allowable minus thickness tolerances specified in 3.8.1. The ground areas shall be a smooth transition to the surrounding surface of the product. Complete elimination of the defect is to be verified by magnetic particle or by liquid penetrant testing.

#### 3.7.7.3.2 Welding repair

Weld repair procedures and the method are to be reported and be approved by PRS. Repair of defects such as unacceptable imperfections, cracks, shells or seams shall be followed by magnetic particle or liquid penetrant testing.

Local defects which cannot be repaired by grinding as stated in 3.7.5.3.1 may be repaired by welding with the agreement of PRS subject to the following conditions:

- .1 Any single welded area shall not exceed 0.125 m<sup>2</sup> and the sum of all areas shall not exceed 2% of the surface side in question;
- .2 The distance between two welded areas shall not be less than their average width;
- .3 The weld preparation shall not reduce the thickness of the product below 80% of the nominal thickness. For occasional defects with depths exceeding the 80% limit, special consideration at the Surveyor's discretion will be necessary'
- .4 If weld repair depth exceeds 3 mm, ultrasonic testing may be requested by PRS. If required, ultrasonic testing shall be carried out in accordance with an approved procedure;
- .5 The repair shall be carried out by qualified welders using an approved procedure for the appropriate steel grade. The electrodes shall be of low hydrogen type and shall be dried in accordance with the manufacturer's requirements and protected against rehumidification before and during welding.

3.7.7.4 The surface quality and condition requirement herein are not applied to products in forms of bars and tubulars, which will be subject to manufacturers' conformance standards.

## 3.8 Inspection of Surface and Work Quality

### 3.8.1 Tolerances

3.8.1.1 Unless otherwise agreed with PRS or specially required, thickness tolerances specified in paragraph 3.8.1.3 apply.



**3.8.1.2** Tolerance for length, width, flatness and over thickness may be in accordance with a recognized national or international standard unless otherwise required by PRS.

**3.8.1.3** Under thickness tolerances of hull plates of 5 mm and above in thickness shall not exceed 0.3 mm.

The under thickness tolerances of hull plates of less than 5 mm in thickness are to be in accordance with a national or international standard, e.g. Class B of ISO 7452:2013. However, the minus tolerance shall not exceed 0.3 mm.

The under thickness tolerances for plates intended for the construction of machinery appliances (except for boilers, pressure vessels and independent tanks for the carriage of liquefied gases and chemicals) shall fulfil the requirements specified in Table 3.8.1.3.

**Table 3.8.1.3**  
**Minus tolerances on nominal thickness for products for machinery structures**

Nominal plate thickness $t$ [mm]	Minus tolerance on nominal thickness [mm]
$3 \leq t < 5$	-0.3
$5 \leq t < 8$	-0.4
$8 \leq t < 15$	-0.5
$15 \leq t < 25$	-0.6
$25 \leq t < 40$	-0.7
$40 \leq t < 80$	-0.9
$80 \leq t < 150$	-1.1
$150 \leq t < 250$	-1.2

**3.8.1.4** Class C of ISO 7452:2013 or equivalent according to national or international standard may be applied in lieu of requirements specified in paragraph 3.8.1.3, in which case the requirements of 3.8.1.7 and 3.8.1.8. need not to be applied.

Additionally, if Class C of ISO 7452:2013 is applied, it is required that the steel mill demonstrates to the satisfaction of PRS that the number of measurements and measurement distribution is appropriate to establish that the mother plates produced are at or above the specified nominal thickness.

**3.8.1.5** Other requirements regarding under thickness tolerances, including tolerances of products intended for the construction of lifting appliances, are subject to PRS acceptance in each particular case.

**3.8.1.6** The tolerances on nominal thickness specified in 3.8.1.3 are not applicable to areas repaired by grinding. For areas repaired by grinding the requirements of 3.7.7.3.1 are to be applied, unless stricter requirements as per recognized standard are considered by PRS.

**3.8.1.7** The average thickness of products, i.e. arithmetic mean of the single measurements made in accordance with the requirements of 3.8.1.8, shall not be less than the nominal thickness.

### **3.8.1.8 Thickness measurements**

**3.8.1.8.1** Automated method or manual method is applied to the thickness measurements.

**3.8.1.8.2** The measurement procedure and the records of measurements shall be made available to the PRS Surveyor and copies provided on request.

**3.8.1.8.3** The thickness shall be measured according to the following requirements.

At least two of three lines shall be selected for the thickness measurements. At least three points on each selected line shall be selected for thickness measurement. The number of measuring points shall be equal on each line. The location of measuring points is defined in Fig. 3.8.1.6.3-1.

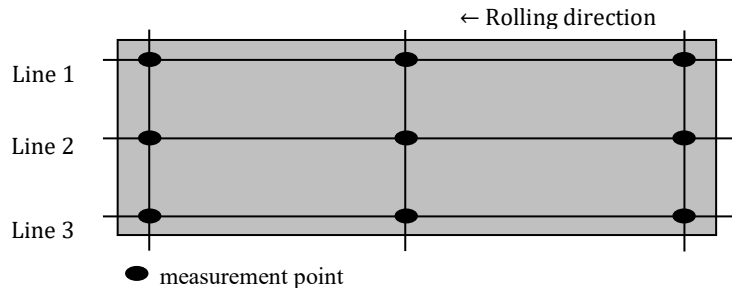

Fig. 3.8.1.8.3-1

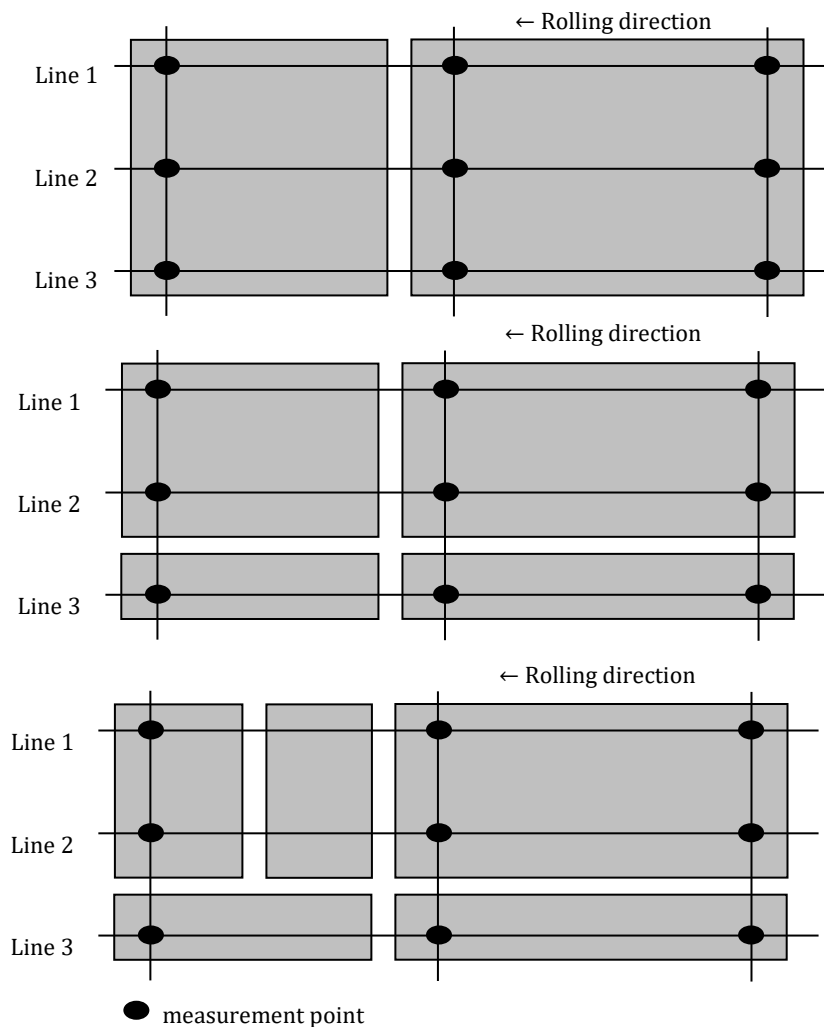

Fig. 3.8.1.8.3-2

For automated methods, the measuring points at sides shall be located not less than 10 mm but not greater than 300 mm from the transverse or longitudinal edges of the product

For manual methods, the measuring points at sides shall be located not less than 10 mm but not greater than 100 mm from the transverse or longitudinal edges of the product.

**Note:**

The measurement locations apply to a product rolled directly from one slab or steel ingot even if the product is to be later cut by the manufacturer. Examples of the original measurements relative to later cut products are shown in Fig. 3.8.1.6.3-2.

### 3.8.2 Identification of Materials

**3.8.2.1** Manufacturer shall furnish PRS Surveyor with information which will enable determining of the material origin.

**3.8.2.2** Steelmaker shall adopt a system for the identification of ingots, slabs and finished products which will enable the material to be traced to its original cast.

### 3.8.3 Inspection and Testing

**3.8.3.1** The manufacturer shall afford the Surveyor all necessary facilities and access to all relevant parts of the works to enable him to verify the approved process is adhered to, for the selection of test materials, and the witnessing of tests, as required by the *Rules* and for verifying the accuracy of the testing equipment.

**3.8.3.2** The prescribed tests and inspections shall be performed at the place of manufacture before the dispatch. Test procedures and specimens shall fulfil the requirements specified in Chapter 2 of this *Part*. Test specimens shall be selected and stamped by PRS Surveyor and tested in his presence, unless otherwise agreed with PRS.

**3.8.3.3** If plates and wide flats with thickness of 15 mm and over are ordered with through thickness properties, the through thickness, tensile test shall be performed on specimens taken perpendicular to the plate surface in accordance with the requirements specified in Chapter 5 of this *Part*.

**3.8.3.4** Verification of dimensions is the responsibility of the steel maker. Acceptance by PRS Surveyor shall not absolve the steel maker from this responsibility.

### 3.9 Test Material

**3.9.1** The term "piece" is understood to mean the rolled product from a single slab, billet or ingot if this is rolled directly into plates, sections or bars. Batch means a number of similar pieces presented as a group for acceptance tests. Test samples are taken from such pieces.

**3.9.2** All material in a batch presented for acceptance tests shall be of the same product form e.g. plates, flats, sections, etc. from the same cast and in the same condition of supply. The test samples shall be fully representative of the material and shall not be cut from the material until heat treatment has been completed. The test samples shall not be separately heat treated in any way.

**3.9.3** Unless otherwise specified, the test specimens shall be taken in accordance with the requirements specified in paragraphs 3.9.3.1, 3.9.3.2 and 3.9.3.3.

**3.9.3.1** From plates and flats with a width of 600 mm or more, the test specimens shall be taken from one end at a position approximately midway between the axis in the direction of the rolling and the edge of the rolled product (see Fig. 3.9.3.1). Unless otherwise agreed, the tensile test specimens (and bend test specimens, if any) shall be prepared with their longitudinal axes transverse to the final direction of rolling.

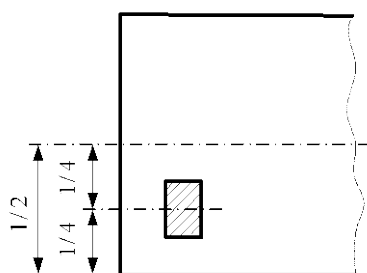

Fig. 3.9.3.1

**3.9.3.2** From flats with a width less than 600 mm, bulb flats and other sections, the test specimens shall be taken from one end at a position approximately one third from the outer edge (see Figures 3.9.3.2-1, 3.9.3.2-2, 3.9.3.2-3 and 3.9.3.2-4 or – in the case of small sections – as near as possible to this position.

In the case of channels and H-sections, the test samples may alternatively be taken from a position approximately one quarter of the width from the web centre line or axis (see Figures 3.9.3.2-3 and 3.9.3.2-4). The tensile test specimens may be prepared with their longitudinal axes either parallel or transverse to the final direction of rolling.

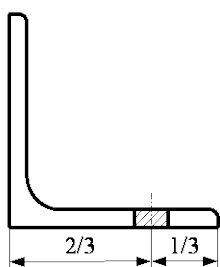

Fig. 3.9.3.2-1

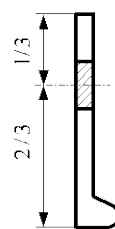

Fig. 3.9.3.2-2

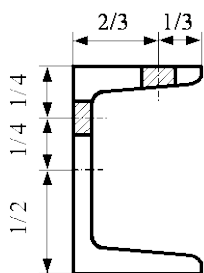

Fig. 3.9.3.2-3

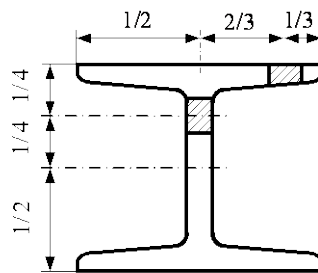

Fig. 3.9.3.2-4

**3.9.3.3** From bars and other similar products, the test specimens shall be taken from one end so that the longitudinal axes of the test specimens are parallel to the direction of rolling and are as near as possible to the following:

- for cylindrical sections, at one third of the radius from the outer edge (see Fig. 3.9.3.3-1),
- for non-cylindrical sections, at one third of the half diagonal from the outer edge (Fig. 3.9.3.3-2).

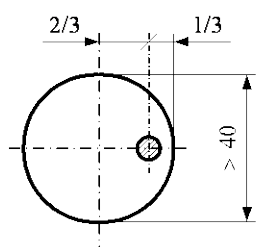

Fig. 3.9.3.3-1

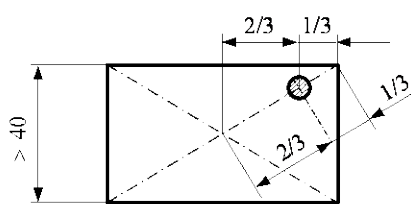

Fig. 3.9.3.3-2

### 3.10 Mechanical Test Specimens

**3.10.1** Tensile test specimens (and bend test specimens, if any), as well as the impact test specimens shall be taken from the thickest product in a batch.

**3.10.2** Dimensions of the tensile test specimens shall be in accordance with the requirements specified in sub-chapter 2.5.3. For plates, wide flats and sections, flat test specimens of full product thickness shall be used. Round test specimens may be used where the product thickness exceeds 40 mm or for bars and other similar products. For small sizes of bars, etc., test specimens shall consist of a suitable length of the full cross section of the product.

**3.10.3** Impact test specimens shall be of Charpy V-notch type cut with their edge within 2 mm from the "as rolled" surface with their longitudinal axes either parallel (indicated "L" in Tables 3.6.2-1 and 3.6.2-2) or transverse (indicated "T") to the final direction of rolling of the material. The position of the notch shall not be nearer than 25 mm to a flame cut or sheared edge. Where the product thickness exceeds 40 mm, the impact test specimens shall be taken with their longitudinal axis at a quarter thickness position.

### 3.11 Number of Test Specimens

#### 3.11.1 Number of Tensile Test Specimens

Unless otherwise agreed with PRS, from each batch presented with a weight not exceeding 50 tonnes, one tensile test specimen shall be taken. Where the weight of a batch is greater than 50 tonnes, an additional specimen shall be taken from each subsequent 50 tonnes or fraction thereof.

Additional test specimens shall be taken for every variation of 10 mm in the thickness or diameter of products from the same batch.

#### 3.11.2 Number of Impact Test Specimens (except E, EH32, EH36, EH40, FH32, FH36 and FH40 steel grades)

Detailed information on the batch size of the materials for the impact tests is provided in Table 3.11.2-1 and Table 3.11.2-2.

Except where otherwise agreed with PRS, for each batch presented, at least one set of three Charpy V-notch test specimens shall be made from one piece unless the weight of finished material is greater than 50 t.

Where steel plates – except for Grade A steel over 50 mm in thickness – are supplied in the as controlled rolled (CR) condition, the frequency of the impact test specimens shall be such that the test specimens shall be made from each subsequent batch of the weight not exceeding 25 tonnes or fraction thereof.



For steel plates of Grades AH40 and DH40 with thickness over 50 mm in normalized or TM condition, one set of impact test specimens shall be made from each batch of 50 tonnes or fraction thereof. For those in QT condition, one set of impact test specimens shall be made from each length as heat treated.

When, subject to PRS consent in each particular case, the material is supplied in the as rolled condition, the frequency of impact tests shall be increased to one set from each batch of 25 tonnes or fraction thereof. In the case of Grade A steel over 50 mm in thickness (supplied in the as rolled condition), a set of impact test specimens shall be made from each subsequent batch of the weight not exceeding 50 tonnes or a fraction thereof.

**3.11.3 Number of Impact Test Specimens (E, EH32, EH36, EH40, FH32, FH36 and FH40 steel grades)**

For steel plates supplied in the as normalized (N) or thermo-mechanically rolled (TM) condition, a set of impact test specimens shall be taken from each plate. For quenched and tempered steel plates, a set of impact test specimens shall be taken from each plate as heat treated.

For sections, a set of impact test specimens shall be taken from each batch with a weight not exceeding 25 tonnes or fraction thereof.

Where, subject to PRS consent in each particular case, sections (except Grades EH40 and FH40) are supplied in the as rolled or controlled rolling (CR) condition, a set of impact test specimens shall be taken from each batch with a weight not exceeding 15 tonnes or fraction thereof.

**3.12 Retest Procedures**

**3.12.1** Where the tensile test for the first piece selected in accordance with sub-chapter 3.9 fails to fulfil the requirements specified in of the *Part IX*, re-test requirements for tensile tests shall be as specified in paragraph 2.3.1.2 of *Part IX*.

**3.12.2** Re-test requirements for Charpy impact test are specified in paragraph 2.3.1 of *Part IX*.

**Table 3.11.2-1  
Required supply condition and number of impact tests for normal strength steels**

Grade	Deoxidation practice	Products	Supply condition (batch for impact tests) <sup>1) 2)</sup>									
			Thickness [mm]									
			10	12.5	20	25	30	35	40	50	100	
A	Rimmed	sections	any (-)				not applicable					
	For $t < 50$ mm – any method except for rimmed. For $t > 50$ mm – killed.	plates	any (-)						N (-) TM (-) <sup>3)</sup> CR (50) AR* (50)			
		sections	any (-)						not applicable			
B	For $t < 50$ mm – any method except for rimmed. For $t > 50$ mm – killed.	plates	any (-)			any (50)			N (50) TM (50) CR (25) AR* (25)			
		sections	any (-)			any (50)			not applicable			
D	Killed	plates, sections	any (50)				not applicable					
	Killed and fine grain treated	plates	any (50)			N (50) CR (50) TM (50)			N (50) CR (25) TM (50)			

Grade	Deoxidation practice	Products	Supply condition (batch for impact tests) <sup>1) 2)</sup>								
			Thickness [mm]								
			10	12.5	20	25	30	35	40	50	100
		sections	any (50)			N (50) TM (50) CR (50) AR* (25)					not applicable
E	Killed and fine grain treated	plates	N (each piece), TM (each piece)								
		sections	N (25), TM (25), CR* (15), AR* (15)						not applicable		
<sup>1)</sup> Supply condition; N – Normalised, CR – Controlled Rolled, TM – Thermo-Mechanical rolling, AR* – As Rolled subject to special approval by PRS, CR* – Controlled Rolled subject to special approval by PRS. <sup>2)</sup> (–) – The numbers in parentheses refer to batch weight in tonnes or fraction thereof. <sup>3)</sup> See Note <sup>5)</sup> to Table 3.6.2-1.											

**Table 3.11.2-2**  
**Required supply condition and number of impact tests for higher strength steels**

Grade	Deoxidation practice	Grain refining elements	Products	Supply condition (batch for impact tests) <sup>1) 2)</sup>							
				Thickness [mm]							
				10	12.5	20	25	30	35	40	50
AH32 <sup>3)</sup> AH36 <sup>3)</sup>	Killed and fine grain treated	Nb and/or V	plates	any (50)	N (50), CR (50), TM (50)					N (50), CR (25), TM (50)	
			sections	any (50)	N (50), CR (50), TM (50)					not applicable	
		Al alone or with Ti	plates	any (50)	AR* (25)						
			sections	any (50)	N (50), CR (50), TM (50), AR* (25)		N (50), CR (25), TM (50)				
AH40	Killed and fine grain treated	any	plates	any (50)	N (50), CR (50), TM (50)					N (50), TM (50), QT (each length as heat treated)	
			sections	any (50)	N (50), CR (50), TM (50)					not applicable	
DH32 DH36	Killed and fine grain treated	Nb and/or V	plates	any (50)	N (50), CR (50), TM (50)					N (50), CR (25), TM (50)	
			sections	any (50)	N (50), CR (50), TM (50), AR* (25)					not applicable	
		Al alone or with Ti	plates	A (50)	AR* (25)		not applicable				
			sections	any (50)	N (50), CR (50), TM (50), AR* (25)		N (50), CR (25), TM (50)				
DH40	Killed and fine grain treated	any	plates	N (50), CR (50), TM (50)					N (50), TM (50), QT (each length as heat treated)		
			sections	N (50), CR (50), TM (50)					not applicable		
EH32 EH36	Killed and fine grain treated	any	plates	N (each piece), TM (each piece)							
			sections	N (25), TM (25), AR* (15), CR* (15)					not applicable		
EH40	Killed and fine grain treated	any	plates	N (each piece), TM (each piece), QT (each length as heat treated)					N (each piece), TM (each piece), QT (each length as heat treated)		
			sections	N (25), TM (25), QT (25)					not applicable		

Grade	Deoxidation practice	Grain refining elements	Products	Supply condition (batch for impact tests) <sup>1) 2)</sup>								
				Thickness [mm]								
				10	12.5	20	25	30	35	40	50	100
FH32 FH36	Killed and fine grain treated	any	plates	N (each piece), TM (each piece), QT (each length as heat treated)						not applicable		
			sections	N (25), TM (25), QT (25), CR* (15)						not applicable		
FH40	Killed and fine grain treated	any	plates	N (each piece), TM (each piece), QT (each length as heat treated)						N (each piece), TM (each piece), QT (each length as heat treated)		
			sections	N (25), TM (25), QT (25)						not applicable		
<sup>1)</sup> Supply condition; N – Normalised, CR – Controlled Rolled, TM – Thermo-Mechanical Rolling, QT – Quenched and Tempered, AR* – As Rolled subject to special approval by PRS, CR* – Controlled Rolled subject to special approval by PRS. <sup>2)</sup> (-) – The numbers in parentheses refer to batch weight in tonnes or fraction thereof. <sup>3)</sup> See Note <sup>3)</sup> to Table 3.6.2-2.												

### 3.13 Marking

Every finished piece shall be marked in accordance with the requirements specified in sub-chapter 1.9 of *Part IX*. Additionally, the marking shall include the following particulars:

- steels which have been specially approved by PRS shall have letter "S" after the above identification mark in accordance with the requirements specified in paragraph 3.1.4 (e.g. AH36S, ES),
- where required by PRS, the material supplied in thermo-mechanically controlled process condition, shall have letters "TM" added after the identification mark (e.g. EH35TM).

### 3.14 Inspection Certificate

*Inspection Certificate* shall include the particulars as required in sub-chapter 1.8 of *Part IX*, and for grade A steel sections of a thickness not exceeding 12.5 mm – additional information on the deoxidation practice applied.

### 3.15 Additional Requirements for Corrosion Resistant Steel Used as the Alternative Means of Corrosion Protection for Cargo Oil Tanks

**3.15.1** The requirements of this sub-chapter apply to steel plates, sections and bars of all grades and thickness up to 50 mm used as specified in IMO Resolution MSC.289(87). Corrosion resistant steels are steels whose corrosion resistance performance in the bottom or top of the internal cargo oil tank is tested and approved to satisfy the requirements in MSC.289(87) in addition to other relevant requirements for hull structural steels. It is not intended that such steels be used for corrosion resistant applications in other areas of a vessel that are outside of those specified in MSC.289(87). Where not specified otherwise, the requirements of sub-chapters 3.2 ÷ 3.14 apply.

**3.15.2** These requirements do not apply to corrosion resistant steels used in applications that are outside of those specified in IMO Resolution MSC.289(87). The requirements for stainless steels are specified in chapter 8.

**3.15.3** Corrosion tests shall be performed in accordance with Appendix C. Approval can be given for application in one of the following areas of a cargo oil tank:

- lower surface of strength deck and surrounding structures,
- upper surface of inner bottom plating and surrounding structures,
- for both strength deck and inner bottom plating.

**3.15.4** The manufacturer shall establish a relationship of all the chemical elements which affect the corrosion resistance. The chemical elements added to achieve this shall be specifically verified for acceptance. Verification shall be based on the ladle analysis of the steel.

**3.15.5** Marking of the material shall meet the requirements of 1.9 and 3.13. Products complying with the requirements of this sub-chapter shall be marked with a designation by adding a corrosion designation mark for the grade of steel, e.g. **AH36 RCB**. The following designations of corrosion resistance shall be used, according to the area of application of steel:

- lower surface of strength deck and surrounding structures – **RCU**,
- upper surface of inner bottom plating and surrounding structures – **RCB**,
- for both strength deck and inner bottom plating – **RCW**.

**3.15.6** When material is supplied in the thermo mechanically controlled process condition, the marking shall have the letters TM added before the corrosion designation, e.g. **EH36 TM RCU Z35**.

### 3.16 Additional Requirements for YP47 Steels and Brittle Crack Arrest Steels

This sub-chapter specifies the requirements on YP47 steels and brittle crack arrest steels intended for application on container carriers according to the requirements of *Part II*. Where not specified otherwise, the requirements of sub-chapters 3.2 ÷ 3.14 apply.

#### 3.16.1 YP47 Steels

**3.16.1.1** Steels designated as YP47 refer to steels with a specified minimum yield point of 460 MPa.

**3.16.1.2** The YP47 steels can be applied to longitudinal structural members in the upper deck region of container carriers (such as hatch side coaming, hatch coaming top and the attached longitudinals, etc.). Special consideration is to be given to the application of YP47 steels for other hull structures.

**3.16.1.3** This sub-chapter gives the requirements for YP47 steels in thickness greater than 50 mm and not greater than 100 mm intended for the upper deck region of container carriers. For YP47 steels outside scope of the said thickness range, special consideration shall be given by PRS.

### 3.16.2 Brittle Crack Arrest Steels

**3.16.2.1** The brittle crack designation can be assigned to YP36, YP40 and YP47 steels which meet the additional brittle crack arrest requirements and properties defined in this sub-chapter.

**3.16.2.2** The application of brittle crack arrest steels is to comply with the requirements of *Part II*, which covers longitudinal structural members in the upper deck region of container carriers (such as hatch side coaming, upper deck, hatch coaming top and the attached longitudinals, etc.).

**3.16.2.3** The thickness range of brittle crack arrest steels is over 50 mm and not greater than 100 mm as specified in Table 3.16.4.3-1.

### 3.16.3 Material Specifications for YP47 Steels

**3.16.3.1** Material specifications for YP47 steels are specified in Tables 3.16.3.1-1 and 3.16.3.1-2.

**Table 3.16.3.1-1**  
**Chemical composition and deoxidation practice for YP47 steels**  
**without specified brittle crack arrest properties**

Steel grade <sup>1)</sup>	EH47
Deoxidation practice	Killed and fine grain treated
Chemical composition, [%] (ladle samples) <sup>5), 6)</sup>	
C max	0.18
Mn	0.90÷2.00
Si max	0.55
P max	0.020
S max	0.020
Al (acid soluble) min.	0.015 <sup>1), 2)</sup>
Nb	0.02÷0.05 <sup>2)</sup> } total
V	0.05÷0.10 <sup>2)</sup> } not more
Ti max	0.02 } than 0.12%
Cu max	0.35
Cr max	0.25
Ni max	1.0
Mo max	0.08
Carbon equivalent CEV max <sup>3)</sup>	0.49
Cold cracking susceptibility $P_{cm}$ max <sup>4)</sup>	0.22

#### Notes:

- <sup>1)</sup> Total aluminium content may be determined instead of the acid soluble content. In that case, the total aluminium content shall not be less than 0.020%.
- <sup>2)</sup> The steel shall contain aluminium, niobium, vanadium or other suitable grain refining elements, either singly or in any combination. When used singly, the steel shall contain the minimum content of the grain refining element, specified in the above Table. When used in combination, the minimum content of the grain refining element, specified in the Table, is not applicable.
- <sup>3)</sup> The carbon equivalent value CEV shall be calculated from the ladle analysis in accordance with formula 3.4.1-2.
- <sup>4)</sup> Cold cracking susceptibility  $P_{cm}$  value shall be calculated in accordance with formula 3.4.3.
- <sup>5)</sup> Where additions of any other element have been made as part of the steelmaking practice subject to approval by PRS, the content shall be indicated in the *Inspection Certificate*.
- <sup>6)</sup> Variations in the specified chemical compositions may be allowed subject to approval by PRS.

**Table 3.16.3.1-2**  
**Supply conditions, grade and mechanical properties for YP47 steels**  
**without specified brittle crack arrest properties <sup>1)</sup>**

Supply condition	Grade	Tensile test			Impact test			
		Yield strength [MPa] min.	Tensile strength [MPa]	Elongation [%] min.	Test temperature [°C]	Average impact energy [J] min.		
						50 < t ≤ 70	70 < t ≤ 85	85 < t ≤ 100
TCMP <sup>2)</sup>	EH47	460	570 ÷ 720	17	-40	L	L	L

t [mm] – thickness

**Notes:**

- <sup>1)</sup> The additional requirements for YP47 steel with brittle crack arrest properties are specified in 3.16.4.  
<sup>2)</sup> Other supply conditions are subject to separate consideration by PRS.

**3.16.4 Material Specifications for Brittle Crack Arrest Steels**

**3.16.4.1** Brittle crack arrest steels are defined as steel plate with the specified brittle crack arrest properties measured by either the brittle crack arrest toughness  $K_{ca}$  or Crack Arrest Temperature (CAT).

**3.16.4.2** In addition to the required mechanical properties for EH36, EH40 and EH47 grades, brittle crack arrest steels shall comply with the requirements specified in Tables 3.16.4.3-1 and 3.16.4.3-2.

**3.16.4.3** The brittle crack arrest properties specified in Table 3.16.4.3-1 are to be evaluated for the products in accordance with the procedure approved by PRS. Test specimens shall be taken from each product unless otherwise agreed by PRS.

**Table 3.16.4.3-1**  
**Requirements of brittle crack arrest properties for brittle crack arrest steels**

Grade <sup>1)</sup>	Thickness t [mm]	Brittle crack arrest properties <sup>2) 6)</sup>	
		Brittle Crack Arrest Toughness $K_{ca}$ at -10 °C [N/mm <sup>3/2</sup> ] <sup>3)</sup>	Crack Arrest Temperature CAT [°C] <sup>4)</sup>
BCA1	50 < t ≤ 100	min. 6000	-10 or below
BCA2	80 < t ≤ 100 <sup>7)</sup>	min. 8000	<sup>5)</sup>

**Notes:**

- <sup>1)</sup> Suffix “BCA1” or “BCA2” is to be affixed to the steel grade designation (e.g. EH40-BCA1, EH47-BCA1, H47-BCA2, etc.).  
<sup>2)</sup> Brittle crack arrest properties for brittle crack arrest steels shall be verified by either the brittle crack arrest toughness  $K_{ca}$  or Crack Arrest Temperature (CAT).  
<sup>3)</sup>  $K_{ca}$  value shall be obtained by the test method specified in Appendix 3 to UR W 31, rev 2, Dec. 2019.  
<sup>4)</sup> CAT shall be obtained by the test method specified in Appendix 4 to UR W 31, rev 2, Dec. 2019.  
<sup>5)</sup> Criterion of CAT for brittle crack arrest steels corresponding to  $K_{ca}=8000$  N/mm<sup>3/2</sup> shall be approved by PRS.  
<sup>6)</sup> Where small-scale tests are used for product testing (batch release testing), these methods shall be approved by PRS in accordance with Annex 5 of IACS UR W31.  
<sup>7)</sup> Lower thicknesses may be approved at the discretion of PRS.

**Table 3.16.4.3-2**  
**Chemical composition and deoxidation practice for brittle crack arrest steels**

Steel grade	EH36-BCA1EH40-BCA1 EH36-BCA2EH40-BCA2	EH47-BCA1 EH47-BCA2
Deoxidation practice	Killed and fine grain treated	
Chemical composition, [%] (ladle samples) <sup>1), 6), 7)</sup>		
C max	0.18	0.18
Mn	0.90÷2.00 <sup>2)</sup>	0.90÷2.00
Si max	0.50	0.55
P max	0.020	0.020
S max	0.020	0.020
Al (acid soluble) min.	0.015 <sup>2), 3)</sup>	0.015 <sup>2), 3)</sup>
Nb	0.02÷0.05 <sup>3)</sup> } total	0,02÷0.05 <sup>3)</sup> } total
V	0.05÷0.10 <sup>3)</sup> } not more	0.05÷0.10 <sup>3)</sup> } not more
Ti max	0.02 } than 0.12%	0.02 } than 0.12%
Cu max	0.50	0.50
Cr max	0.25	0.50
Ni max	2.0	2.0
Mo max	0.08	0.08
Carbon equivalent CEV max <sup>4)</sup>	0.47 0.49	0.55
Cold cracking susceptibility $P_{cm}$ max <sup>5)</sup>	-	0.24

**Notes:**

- 1) Chemical composition of brittle crack arrest steels shall comply with the Table, regardless of chemical composition specified in Tables 3.4.1-2 and 3.16.3.1-1.
- 2) Total aluminium content may be determined instead of the acid soluble content. In such cases the total aluminium content shall not be less than 0.020%.
- 3) The steel shall contain aluminium, niobium, vanadium or other suitable grain refining elements, either singly or in any combination. When used singly, the steel shall contain the minimum content of the grain refining element, specified in the above Table. When used in combination, the minimum content of the grain refining element, specified in the Table, is not applicable.
- 4) The carbon equivalent value CEV shall be calculated from the ladle analysis in accordance with formula 3.4.1-2.
- 5) Cold cracking susceptibility  $P_{cm}$  value shall be calculated in accordance with formula 3.4.3.
- 6) Where additions of any other element have been made as part of the steelmaking practice subject to approval by PRS, the content shall be indicated in the *Inspection Certificate*.
- 7) Variations in the specified chemical compositions may be allowed subject to approval by PRS.



## 4 HIGH STRENGTH STEELS

### 4.1 Application

**4.1.1** The requirements specified in this Chapter apply to plates, wide flats, sections, bars and seamless tubes of hot-rolled, fine-grain, weldable high strength structural steels, intended for use in marine and offshore structural applications. These requirements do not apply to steels intended for hull structure of commercial ships whose requirements are specified in Chapter 3.

**4.1.2** Steels covered by the scope of these requirements are specified into the following eight yield stress  $R_e$  levels: 420, 460, 500, 550, 620, 690, 890 and 960 MPa. For each yield stress level, four forms of toughness: A, D, E and F are specified based on the impact test temperature, except for yield stress level of 890 and 960 MPa for which grade F is not applicable. List of grades is specified in Table 4.1.2.

**Table 4.1.2**

A420	D420	E420	F420
A460	D460	E460	F460
A500	D500	E500	F500
A550	D550	E550	F550
A620	D620	E620	F620
A690	D690	E690	F690
A890	D890	E890	
A960	D960	E960	

**4.1.3** Steels covered by the scope of this Chapter shall be supplied in normalized (N)/normalized rolled (NR), thermo-mechanical controlled rolled (TM) or quenched and tempered (QT) condition.

**4.1.4** Steels with a thickness above the maximum thicknesses given in Table 4.5.4 are subject to PRS approval in each particular case.

**4.1.5** Steels differing in chemical composition, deoxidation practice, supply condition or mechanical properties are subject to PRS approval in each particular case. Such steels are to be given a special designation.

### 4.2 Approval

**4.2.1** High strength steels shall be manufactured by the works approved by PRS for the type and grade of steel which is being supplied. The procedure for approval is shown in Appendix E

**4.2.2** It is the manufacturer's responsibility to ensure that effective quality, process and production controls during manufacturing are adhered to within the manufacturing specifications. The manufacturing specification shall be submitted to PRS.

**4.2.3** Where during control imperfection inducing possible inferior quality of product occurs, the manufacturer shall identify the cause and establish a countermeasure to prevent its recurrence. Also the complete investigation report shall be submitted to PRS. PRS may require that the frequency of testing for subsequent products offered shall be increased to gain confidence in the quality.

**4.2.4** When semi-finished product is not produced at the approved manufacturer of the finish rolled and heat treated products, the manufacturer of the semi-finished product shall also be subject to approval by PRS.

### 4.3 Manufacturing Methods

**4.3.1** Steel shall be manufactured by the basic oxygen, electric furnace or by other processes specially approved by PRS.

**4.3.2** Vacuum degassing shall be used for the following steels:

- all steels with enhanced through-thickness properties,
- steels of grades A690÷A960, D690÷D960, E690÷E960 and F690.

**4.3.3** Steel shall be fully killed.

**4.3.4** Steel shall be fine grain treated and shall have a fine grain structure (equivalent index  $\geq 6$  determined by micrographic examination in accordance with ISO 643 standard or alternative test method). The fine grain practice shall be as detailed in the manufacturing specification.

**4.3.5** Steel shall contain nitrogen binding elements as detailed in the manufacturing specification.

### 4.4 Chemical Composition

**4.4.1** The chemical composition shall be determined by the steelmaker in an adequately equipped and competently staffed laboratory. The method of sampling is to follow that carried out for the initial approval tests, either from the ladle, the tundish or the mould in the case of continuous casting. The aim analysis shall fulfil the manufacturing specification as well as the requirements specified in Table 4.4.1. All the elements listed in Table 4.4.1 are to be reported.

**Table 4.4.1**  
**Chemical Composition of High Strength Steels**

Supply condition		N/NR		TM		QT	
Steel grade		A420÷A460 D420÷D460	E420÷E460	A420÷A890 D420÷D690	E420÷E890 F420÷F690 D890	A420÷A960 D420÷D690	E420÷E960 F420÷F690 D890÷D960
Chemical composition [%]	C max	0.20	0.18	0.16	0.14	0.18	
	Mn	1.00÷1.70		1.00÷1.70		max. 1.70	
	P max <sup>1)</sup>	0.030	0.025	0.025	0.020	0.025	0.020
	S max <sup>1)</sup>	0.025	0.020	0.015	0.010	0.015	0.010
	Al total min. <sup>2)</sup>	0.020		0.020		0.018	
	Nb max <sup>3)</sup>	0.05		0.05		0.06	
	V max <sup>3)</sup>	0.20		0.12		0.12	
	Ti max <sup>3)</sup>	0.05		0.05		0.05	
	Ni max <sup>4)</sup>	0.80		2.00 <sup>4)</sup>		2.00 <sup>4)</sup>	
	Cu max	0.55		0.55		0.50	
	Mo max <sup>3)</sup>	0.10		0.50		0.70	
	N max	0.025		0.025		0.015	
	O max <sup>5)</sup>	–		–		50 ppm	–

<sup>1)</sup> For sections the P and S content can be 0.005% higher than the value specified in the table.

<sup>2)</sup> The total Al/N ratio shall be a minimum of 2:1. When other nitrogen binding elements are used, the minimum Al content and Al/N ratio do not apply.

<sup>3)</sup> Total Nb+V+Ti  $\leq 0.26\%$  and Mo+Cr  $\leq 0.65\%$ , not applicable for steels in QT condition.

<sup>4)</sup> Higher Ni content subject to PRS approval.

<sup>5)</sup> The requirements on maximum O content is only applicable to D890, E890, D960 and E960 grades.

**4.4.2** Elements used for alloying, nitrogen binding, and fine grain treatment, and as well as the residual elements are to be as detailed in the manufacturing specification, e.g. when boron is deliberately added for enhancement of hardenability, the maximum content of boron shall not be higher than 0.005% and the analysis result shall be reported.

**4.4.3** The carbon equivalent value shall be calculated from the ladle analysis. Maximum values are specified in Table 4.4.3.

The carbon equivalent value shall be calculated using following formulas:

a) for all steel grades:

$$CEV = C + \frac{Mn}{6} + \frac{Cr+Mo+V}{5} + \frac{Ni+Cu}{15} [\%]$$

b) for steel grades A460, D460, E460, F460 and higher, CET value may be used instead of CEV at the discretion of the manufacturer:

$$CET = C + \frac{(Mn+Mo)}{10} + \frac{Cr+Cu}{20} + \frac{Ni}{40} [\%]$$

c) for steels in TM and QT condition with carbon content not more than 0.12%, the cold cracking susceptibility  $P_{cm}$  may be used instead of CEV:

$$P_{cm} = C + \frac{Si}{30} + \frac{Mn}{20} + \frac{Cu}{20} + \frac{Ni}{60} + \frac{Cr}{20} + \frac{Mo}{15} + \frac{V}{10} + 5B [\%]$$

**Table 4.4.3**  
**Maximum Values of CEV, CET and  $P_{cm}$**

Steel grade	Supply condition	CEV, [%]						CET [%]	$P_{cm}$ [%]
		Plates			Sections	Bars	Tubes		
		$t \leq 50$ mm	$50 < t \leq 100$ mm	$100 < t \leq 250$ mm	$t \leq 50$ mm	$t \leq 250$ mm or $d \leq 250$ mm	$t \leq 65$ mm		
AH420÷ FH420	N/NR	0.46	0.48	0.52	0.47	0.53	0.47	NA	NA
	TM	0.43	0.45	0.47	0.44	NA	NA		
	QT	0.45	0.47	0.49	NA	NA	0.46		
AH460÷ FH460	N/NR	0.50	0.52	0.54	0.51	0.55	0.51	0.25	NA
	TM	0.45	0.47	0.48	0.46	NA	NA	0.30	0.23
	QT	0.47	0.48	0.50	NA	NA	0.48	0.32	0.24
AH500÷ FH500	TM	0.46	0.48	0.50	NA	NA	NA	0.32	0.24
	QT	0.48	0.50	0.54			0.50	0.34	0.25
AH550÷ FH550	TM	0.48	0.50	0.54	NA	NA	NA	0.34	0.25
	QT	0.56	0.60	0.64			0.56	0.36	0.28
AH620÷ FH620	TM	0.50	0.52	NA	NA	NA	NA	0.34	0.26
	QT	0.56	0.60	0.64			0.58	0.38	0.30
AH690÷ FH690	TM	0.56	NA	NA	NA	NA	NA	0.36	0.30
	QT	0.64	0.66	0.70			0.68	0.40	0.33
AH890÷ EH890	TM	0.60	NA	NA	NA	NA	NA	0.38	0.28
	QT	0.68	0.75				0.40	NA	
AH960÷ EH960	QT	0.75	NA	NA	NA	NA	NA	0.40	NA

## 4.5 Supply Condition

**4.5.1** High strength steel products shall be supplied in accordance with the processes approved by PRS. These processes include:



- Normalized (N)/Normalized rolled (NR),
- Thermo-mechanical controlled rolled (TM)/with accelerated cooling (TM+AcC)/with direct quenching followed by tempering (TM+DQ), or
- Quenched and Tempered condition (QT).

**Note:** Direct quenching after hot-rolling followed by tempering is considered equivalent to conventional quenching and tempering.

**4.5.2** The rolling reduction ratio of slab, billet, bloom or ingot shall not be less than 3:1.

**4.5.3** The maximum thickness of slab, billet or bloom for the continuous casting process shall be at the manufacturer's discretion.

**4.5.4** Maximum thickness of plates, sections, bars and tubulars over which a specific supply condition is applicable are shown in Table 4.5.4.

**Table 4.5.4**  
**Maximum Thickness Limits**

Supply condition	Maximum thickness [mm]			
	Plates	Sections	Bars	Tubes
N	250 <sup>2)</sup>	50	250	65
NR	150	1)		
TM	150	50	NA	NA
QT	150 <sup>2)</sup>	50	NA	50

<sup>1)</sup> The maximum thickness limits of sections, bars and tubulars manufactured by normalized rolling (NR) are less than those supplied in normalized (N) condition and shall be agreed with PRS.

<sup>2)</sup> Approval for steels supplied in normalized (N) condition with thickness larger than 250 mm and quenched and tempered (QT) steels with thickness larger than 150 mm is subject to the special consideration by PRS.

## 4.6 Mechanical Properties

### 4.6.1 Tensile Test

Test specimens shall be cut with their longitudinal axes transverse to the final direction of rolling, except in the case of sections, bars, tubulars and rolled flats with a finished width of 600 mm or less, where the tensile specimens may be taken in either the longitudinal or transverse direction subject to PRS acceptance in each particular case. Full thickness flat tensile test specimens shall be so prepared as to maintain the rolling scale at least at one side. When the capacity of the test machines is exceeded by the use of a full thickness specimen, sub-sized flat tensile specimens representing either the full thickness or half of the product thickness retaining one rolled surface are to be used. Alternatively, machined round test specimens may be used. In that case, the axis of the specimen shall be located at a position lying at a distance of  $t/4$  from the surface and additionally at  $t/2$  for thickness above 100 mm or as near as possible to this position.

The test results shall fulfil the relevant requirements specified in Table 4.6.1-1.

**Table 4.6.1-1**  
**Mechanical properties for high strength steels**

Grade of steel	Tensile properties						Charpy V-notch impact test			
	Yield stress $R_e$ or $R_{p0.2}$ <sup>1)</sup> [MPa] min.			Tensile strength $R_m$ [MPa]		Elongation $A$ <sup>2)</sup> [%] min.		Test temperature [°C]	Average energy $KV$ [J] min.	
	Nominal thickness, $t$ <sup>4)</sup> [mm]								T	L
	$\geq 3 \leq 50$	$> 50 \leq 100$	$> 100 \leq 250$	$\geq 3 \leq 100$	$> 100 \leq 250$	T	L <sup>3)</sup>		T	L
AH420	420	390	365	520÷680	470÷650	19	21	0	28	42
DH420								-20		
EH420								-40		
FH420								-60		
AH460	460	430	390	540÷720	500÷710	17	19	0	31	46
DH460								-20		
EH460								-40		
FH460								-60		
AH500	500	480	440	590÷770	540÷720	17	19	0	33	50
DH500								-20		
EH500								-40		
FH500								-60		
AH550	550	530	490	640÷820	590÷770	16	18	0	37	55
DH550								-20		
EH550								-40		
FH550								-60		
AH620	620	580	560	700÷890	650÷830	15	17	0	41	62
DH620								-20		
EH620								-40		
FH620								-60		
AH690	690	650	630	770÷940	710÷900	14	16	0	46	69
DH690								-20		
EH690								-40		
FH690								-60		
AH890	890	830	NA	940÷1100	NA	11	13	0	46	69
DH890								-20		
EH890								-40		
AH960	960	NA	NA	980÷1150	NA	10	12	0	46	69
DH960								-20		
EH960								-40		

L – longitudinal specimen, T – transverse specimen, NA – not applicable

**Notes:**

1. For tensile test either the upper yield strength ( $R_{eH}$ ) or where  $R_{eH}$  cannot be determined, the 0.2% proof strength ( $R_{p0.2}$ ) is to be determined and the material is considered to comply with the requirement if either value meets or exceeds the specified minimum value of yield strength.
2. For full thickness non-proportional flat specimens with the following dimensions:  $a = t$ ,  $b = 25$  mm,  $L_o = 200$  mm, the elongation shall fulfil the requirements specified in Table 4.6.1-2.
3. In the case that tensile specimen is parallel to the final rolling direction, the test result shall comply with the requirement of elongation for longitudinal (L) direction.

4. For plates and sections for applications, such as racks in offshore platforms, etc., where the design requires that tensile properties are maintained through the thickness, a decrease in the minimum specified tensile properties is not permitted with an increase in the thickness.

For product forms other than plates and wide flats for which tests on longitudinal specimens are accepted, the elongation value shall be greater by 2% than those specified in Table 4.6.1-1 and Table 4.6.1-2.

**Table 4.6.1-2**  
**Elongation  $A_{200\text{ mm}}$  minimum values for non-proportional flat specimens <sup>1)</sup>**

Strength level	Thickness $t$ [mm]						
	$\leq 10$	$10 < t \leq 15$	$15 < t \leq 20$	$20 < t \leq 25$	$25 < t \leq 40$	$40 < t \leq 50$	$50 < t \leq 70$
	Elongation $A_{200\text{ mm}}$ [%], min.						
420	11	13	14	15	16	17	18
460	11	12	13	14	15	16	17
500	10	11	12	13	14	15	16
550	10	11	12	13	14	15	16
620	9	11	12	12	13	14	15
690	9 <sup>2)</sup>	10 <sup>2)</sup>	11 <sup>2)</sup>	11	12	13	14

**Notes:**

- The tabulated elongation minimum values are the requirements for testing specimen in transverse direction. Specimens for strength levels 890 and 960 MPa and specimens which are not included in this table shall be proportional specimens with a gauge length of  $L_0 = 5.65\sqrt{S_0}$ .
- For steel plates with strength level 690 MPa with thickness not higher than 20 mm, round specimen in accordance with Chapter 2 may be used instead of the flat tensile specimen. The minimum elongation for testing specimen in transverse (T) direction is 14%.

## 4.6.2 Impact Test

From each piece as heat treated at least one set of impact test specimens shall be taken and tested in accordance with the requirements specified in sub-chapter 2.6 of this *Part*.

Unless otherwise accepted by PRS, the V-notch impact test specimens for plates and wide flats over 600 mm in width shall be taken with their axes transverse to the main rolling direction (see Fig. 2.6.1 in this *Part*). For flats with the width not exceeding 600 mm and other product forms, the impact tests shall be performed on longitudinal specimens.

The test results shall fulfil the requirements specified in Table 4.6.1-1.

Normally sub-surface test specimens shall be taken in such a way that one side is not further away than 2 mm from a rolled surface, however, for material with a thickness in excess of 50 mm, impact tests shall be taken at (or as near as practicable) the quarter thickness ( $t/4$ ) and mid-thickness ( $t/2$ ) locations.

Impact test for a nominal thickness less than 6 mm are normally not required.

## 4.6.3 Number of Test Samples

### 4.6.3.1 Number of Tensile Test Samples

Tensile test sample is to be randomly selected from each batch, that is to be less than or equal 25 tonnes, and to be from the same cast, in the same supply condition and of the same thickness.

#### 4.6.3.2 Number of Impact Test Samples

For steel plates in N/NR or TM condition test sample is to be taken from each piece. For steels in QT condition test sample is to be taken from each individually heat treated part thereof. For sections, bars and tubulars, test sample is to be taken from each batch of 25 tonnes or fraction thereof. For continuous heat-treated plates, the scope of tests as well as the number and location of test specimens are subject to PRS acceptance in each particular case.

#### 4.6.4 Traceability

Traceability of test material, specimen sampling and test procedures including test equipment with respect to mechanical properties testing, is to be in accordance with Chapter 3 of this *Part*.

#### 4.6.5 Re-test Procedures

Unless the tensile and impact test results fulfil the requirements specified in this *Part* of the *Rules*, re-test procedures in accordance with the requirements specified in sub-chapter 2.3 of this *Part* apply.

#### 4.6.6 Through Thickness Tensile Test

For steels designated with improved through thickness properties or if required by PRS, through thickness tensile tests shall be performed in accordance with the requirements specified in Chapter 5 of this *Part*. Unless otherwise agreed with PRS, through thickness tensile strength shall be not less than 80% of the specified minimum tensile strength.

#### 4.7 Tolerances

Unless otherwise agreed with PRS or specially required, the thickness tolerances specified in sub-chapter 3.8 of this *Part* apply.

#### 4.8 Surface and Work Quality

Surface inspection and verification of internal soundness is the responsibility of the manufacturer. The acceptance by PRS Surveyor of material later found defective shall not absolve the manufacturer of this responsibility.

All materials shall be free from cracks, injurious surface flaws, injurious laminations and similar defects.

The surface quality inspection method shall be in accordance with recognised national or international standards agreed by purchaser and manufacturer.

Welding repair procedures and the method for reporting repairs shall be agreed with PRS in each particular case.

Where repair by grinding is performed, then the remaining plate thickness below the ground area shall be within the allowable under thickness tolerance in accordance with the requirements of sub-chapter 3.8.1 of this *Part*.

Surface finish requirements shall be in accordance with the requirements of sub-chapter 3.7 of this *Part*.

If required by PRS, the manufacturer shall perform ultrasonic testing in accordance with standard PN-EN 10160, Level S1/E1 or standard ASTM A578, Level C.

#### 4.9 Stress-relieving Heat Treatment and Other Heat Treatments

Steels approved by the procedures given in Appendix E. with respect to heat treatment are suitable for stress-relieving heat treatment such as post-weld heat treatment and stress-relieving heat treatment after cold forming for the purpose of reducing the risk of brittle fracture, increasing the fatigue lifetime and dimensional stability for machining.

#### 4.10 Facilities for Inspection

The manufacturer is to afford the PRS Surveyor all necessary facilities and access to all relevant parts of the steel works to enable him to verify the approved process is adhered to, for the selection of test materials, and the witnessing of tests, also for verifying the accuracy of the testing, calibration of inspection equipment and traceability of materials.

#### 4.11 Material Identification

**4.11.1** Steelmaker shall furnish PRS Surveyor the information to enable determining the material origin.

**4.11.2** Steelmaker shall adopt a system for identification of ingots, slabs, billet or bloom and finished products which will enable the material to be traced to its original cast.

#### 4.12 Marking

Each finished piece shall be marked in accordance with the requirements specified in sub-chapter 1.9 of this *Part*. Marking shall include following particulars:

- grade of steel,
- manufacturer mark or initials
- cast/heat number, plate number or equivalent identification mark,
- supply condition,
- PRS stamp.

The entire markings are to be encircled with paint or otherwise marked so as to be easily recognised. Steels which have been specially approved by PRS and which differ from requirements of this Chapter shall have the letter “S” after the identification mark (e.g. EH620S).

#### 4.13 Inspection Certificate

The PRS Surveyor shall be supplied with two copies of the test certificates or shipping statements of all accepted materials. In addition to the description, dimensions, etc., of the material, the following particulars shall be included:

- purchaser’s order No.,
- identification of the cast and piece,
- manufacturer’s identification,
- grade of steel,
- chemical analysis, CEV, CET or  $P_{cm}$  value,
- supply condition with heat treatment particulars,
- mechanical properties test results, including traceable test identification,
- surface quality and inspection results,
- ultrasonic test result, where applicable.

The manufacturer is required to provide a written declaration stating that the material has been made by an approved process, and that it has been subjected to and has withstood satisfactory the required tests in the presence of the PRS Surveyor. The following form of declaration will be



accepted if stamped or printed on each test certificate with the name of the manufacturer and signed by an authorised representative of the manufacturer:

*“We hereby certify that the material has been made by an approved process and has been satisfactorily tested in accordance with the PRS Rules”.*

*Inspection Certificate* shall include the particulars as required in sub-chapter 1.8 of this *Part*, and additional information on the supply condition and heat treatment temperature applied.

## 5 STEEL WITH SPECIFIED THROUGH THICKNESS PROPERTIES (STEEL “Z”)

### 5.1 General Requirements

**5.1.1** The requirements of Chapter 5 supplement those set forth in Chapters 3 and 4 of this *Part* for thick and universal plates (wide flats) with thickness greater than or equal to 15 mm which are intended to have a specified minimum ductility in the through thickness direction (i.e. “Z” direction, see Fig. 5.1.1). Products with a thickness less than 15 mm may be included at the discretion of PRS.

The use of such material, known as “Z” quality steel, is recommended for structural details subject to strains in the through thickness direction to minimise the possibility of lamellar tearing during fabrication.

Two “Z” quality steels are specified:

- Z25 for normal ship applications,
- Z35 for more severe applications.

Through thickness properties are characterised by specified values for reduction of area in a through thickness tensile test.

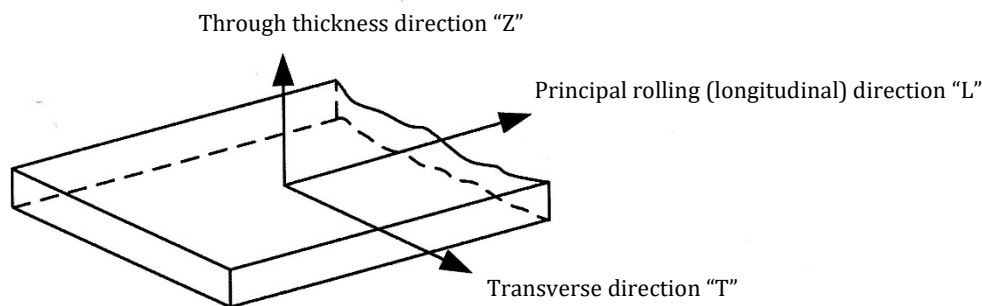

Fig. 5.1.1

**5.1.2** „Z” quality steels shall be manufactured at works approved by PRS. The approval shall follow the procedure specified in Annex A to this *Part* and shall also take into account the improved steelmaking techniques such as calcium treatment, vacuum degassing and argon stirring as well as control of centre-line segregation during continuous casting.

**5.1.3** Chemical composition shall fulfil the requirements specified in Chapters 3 and 4 of this *Part*, taking into account that the maximum sulphur content shall be 0.008% determined by the ladle analysis.

### 5.2 Reduction of Area

The minimum average value for reduction of area “Z” of at least 3 tensile test specimens taken in through thickness direction of the products shall be as shown for the appropriate grade given in Table 5.2. Only one individual value may be below the minimum average value, but no less than minimum value shown for the particular grade (see Fig. 5.3.4). A value less than the minimum individual value is a cause for rejection.

**Table 5.2**  
**Reduction of area allowable values for steels with specified through thickness properties**

Grade	Z25	Z35
Minimum average	≥ 25%	≥ 35%
Minimum individual	≥ 15%	≥ 25%

Reduction of area shall be calculated in accordance with the formula below:

$$Z = \frac{S_0 - S}{S_0} \cdot 100 [\%] \tag{5.2}$$

where:

$S_0$  – cross-section area of the specimen before breakage, [mm<sup>2</sup>],

$S$  – cross-section area of the specimen at the point of fracture, [mm<sup>2</sup>].

### 5.3 Testing

**5.3.1** In addition to the requirements of the appropriate steel specification as per Chapters 3 or 4, preparation of specimens and testing procedures shall be as specified below.

**5.3.2** For plates and wide flats, one test sample shall be taken close to the longitudinal centreline of one end of each rolled piece representing the batch (see Table 5.3.2 and Fig. 5.3.2).

**Table 5.3.2**  
**Batch size dependent on product and sulphur content**

Product	$S > 0.005\%$	$S \leq 0.005\%$
Plates	Each piece	Maximum 50 t of the products of the same cast, thickness and supply condition
Universal plates with thickness $\leq 25$ mm	Maximum 10 t of the products of the same cast, thickness and supply condition.	
Universal plates with thickness $> 25$ mm	Maximum 20 t of the products of the same cast, thickness and supply condition.	

The test sample shall be taken close to the longitudinal centreline as shown in Fig. 5.3.2, preferably from the top part of the ingot.

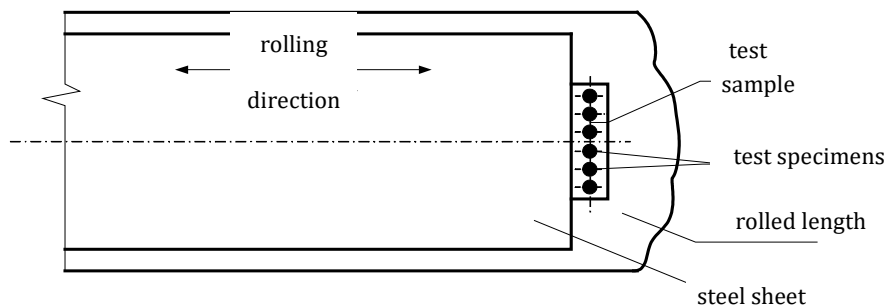

Fig. 5.3.2

The test sample shall be large enough to allow for preparation of 6 specimens.

**5.3.3** Three specimens shall be prepared for the tensile test while the rest of the sample remains for possible retest.

The test specimens shall be machined up to the dimensions given in Fig. 5.3.3-1 or in Fig. 5.3.3-2, depending on the thickness  $t$  of the tested plate.

The parallel (cylindrical) length  $L_c$  of the specimen shall not be less than  $2d$ .

Where the product thickness does not allow to prepare specimens of sufficient length suitable for the gripping jaws of the testing machine, the ends of the specimens may be extended by padding – as indicated with a hatched area in Fig. 5.3.3-2 – or by welding on an appropriate piece of material having the strength not less than that of the tested material.

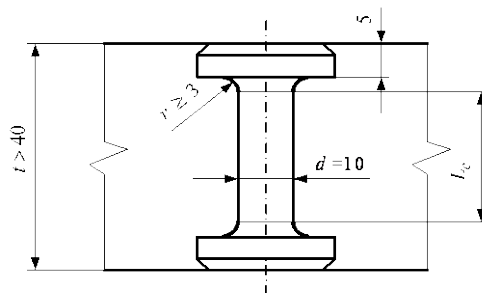
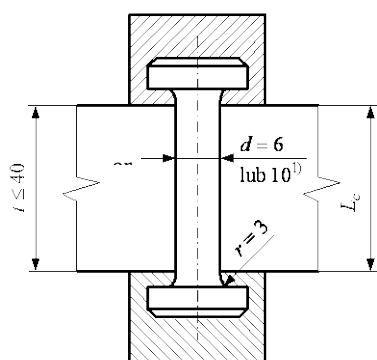

Fig. 5.3.3-1

Round specimens, including those of the padding-extended type, shall be prepared in accordance with standard PN-EN 10164.



1) Where thickness  $t > 25$  mm, specimens of diameter  $d = 10$  mm shall be taken.

Fig. 5.3.3-2

**5.3.4** The test is considered invalid and further test is required if:

- the specimen has been damaged during machining,
- the weld has been made improperly,
- fracture occurs in the weld or heat-affected zone,
- improper operation of the testing machine or improper grip in its jaws has been found.

Figure 5.3.4 shows the three cases where a retest is permitted. In these instances three more tensile tests shall be taken from the remaining sample. The average of all six tensile tests shall be greater than the required minimum average with no more than two results below the minimum average.

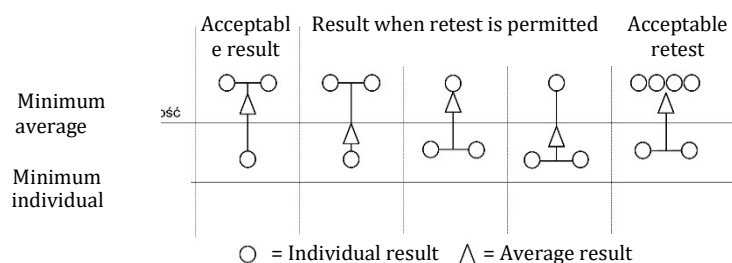

Fig. 5.3.4. Diagram showing acceptance/rejection criteria

**5.3.5** In the case of failure after retest, either the batch represented by the piece is rejected or each piece within the batch is required to be tested.

**5.3.6** Unless otherwise agreed, all plates of “Z” quality steels shall be ultrasonic tested. The acceptance standards shall be approved by PRS. Neither edge cracks nor delaminations are permitted. Ultrasonic testing is required and it shall be performed – in accordance with either EN 10160:1999 Level S1/E1 or ASTM A 578:2017 Level C – on each piece in the final supply conditions and with a probe frequency of 4 MHz.

#### **5.4 Marking**

Each rolled length shall be marked with a sign to be added to hull and high strength steel plates designation, e.g. E-Z25, EH36-Z25, etc.

#### **5.5 Inspection Certificate**

The following information is required to be included in *Inspection Certificate* in addition to the appropriate steel requirements given in sub-chapter 1.8 of this *Part*:

- .1 through thickness reduction in area [%],
  - .2 steel grade with Z25 or Z35 notation.
-

## 6 STEEL FOR BOILERS AND PRESSURE VESSELS

### 6.1 General Requirements

#### 6.1.1 Application

**6.1.1.1** The requirements specified in this Chapter apply to unalloyed and alloy steel plates intended for boilers, pressure vessels and heat exchangers for service at elevated temperatures which are subject to PRS survey. Mechanical properties of the plates at elevated temperatures are also specified.

**6.1.1.2** Chemical composition and mechanical properties of rolled steels intended for pressure vessels operating at low temperatures are subject to PRS acceptance in each particular case.

#### 6.1.2 Method of Manufacture

**6.1.2.1** Steel shall be manufactured by the open hearth, basic oxygen processes, electric furnace or by other processes approved by PRS.

**6.1.2.2** Steel shall be in the killed condition.

**6.1.2.3** The reduction ratio of thickness from continuously cast slab to plate shall not be less than 5:1. Other values of the reduction are subject to PRS acceptance in each particular case.

### 6.2 Steel Grades

The requirements specified in this Chapter apply to unalloyed quality steel plates (e.g. P235GH) as well as special alloy steel plates (e.g. 16Mo3) of thicknesses and supply conditions as specified in sub-chapters 6.4 and 6.5.

### 6.3 Chemical Composition

**6.3.1** Chemical composition of unalloyed quality steels and special alloy steels intended for service at elevated temperatures shall fulfil the requirements specified in Table 6.3.1.

**6.3.2** Permissible deviations in the chemical analysis shall fulfil the requirements specified in standard PN-EN 10028-2.

**6.3.3** For unalloyed quality steels, carbon equivalent value CEV shall be calculated in accordance with the formula below:

$$CEV = C + \frac{Mn}{6} + \frac{Cr+Mo+V}{5} + \frac{Ni+Cu}{15} \quad [\%] \quad (6.3.3)$$

**Table 6.3.1**  
**Chemical composition (ladle analysis) <sup>1)</sup>**

Steel grade	[%] mass														
	C	Si	Mn	P max.	S max.	Al <sub>total</sub>	N	Cr	Cu <sup>2)</sup>	Mo	Nb	Ni	Ti max.	V	Other
P235GH	≤0.18	≤0.35	0.60÷1.20	0.025	0.015	≥0.020	≤0.012 <sup>4)</sup>	≤0.30	≤0.30	≤0.08	≤0.020	≤0.30	0.03	≤0.02	Cr+Cu+ Mo+Ni ≤0.70
P265GH	≤0.20	≤0.40	0.80÷1.40	0.025	0.015	≥0.020	≤0.012 <sup>4)</sup>	≤0.30	≤0.30	≤0.08	≤0.020	≤0.30	0.03	≤0.02	
P295GH	0.08÷0.20	≤0.40	0.90÷1.50	0.025	0.015	≥0.020	≤0.012 <sup>4)</sup>	≤0.30	≤0.30	≤0.08	≤0.020	≤0.30	0.03	≤0.02	
P355GH	0.10÷0.22	≤0.60	1.10÷1.70	0.025	0.015	≥0.020	≤0.012 <sup>4)</sup>	≤0.30	≤0.30	≤0.08	≤0.020	≤0.30	0.03	≤0.02	
16Mo3	0.12÷0.20	≤0.35	0.40÷0.90	0.025	0.010	<sup>5)</sup>	≤0.012	≤0.30	≤0.30	0.25÷0.35	–	≤0.30	–	–	–
18MnMo4-5	≤0.20	≤0.40	0.90÷1.50	0.015	0.005	<sup>5)</sup>	≤0.012	≤0.30	≤0.30	0.45÷0.60	–	≤0.30	–	–	–
20MnMoNi4-5	0.15÷0.23	≤0.40	1.00÷1.50	0.020	0.010	<sup>5)</sup>	≤0.012	≤0.20	≤0.20	0.45÷0.60	–	0.40÷0.80	–	≤0.02	–
15NiCuMoNb5-6-4	≤0.17	0.25÷0.50	0.80÷1.20	0.025	0.010	≥0.015	≤0.020	≤0.30	0.50÷0.80	0.25÷0.50	0.015÷0.045	1.00÷1.30	–	–	–
13CrMo4-5	0.08÷0.18	≤0.35	0.40÷1.00	0.025	0.010	<sup>5)</sup>	≤0.012	0.70÷1.15	≤0.30	0.40÷0.60	–	–	–	–	–
13CrMoSi5-5	≤0.17	0.50÷0.80	0.40÷0.65	0.015	0.005	<sup>5)</sup>	≤0.012	1.00÷1.50	≤0.30	0.45÷0.65	–	≤0.30	–	–	–
10CrMo9-10	0.08÷0.14 <sup>7)</sup>	≤0.50	0.40÷0.80	0.020	0.010	<sup>5)</sup>	≤0.012	2.00÷2.50	≤0.30	0.90÷1.10	–	–	–	–	–
12CrMo9-10	0.10÷0.15	≤0.30	0.30÷0.80	0.015	0.010	0.01÷0.04	≤0.012	2.00÷2.50	≤0.25	0.90÷1.10	–	≤0.30	–	–	–
X12CrMo5	0.10÷0.15	≤0.50	0.30÷0.60	0.020	0.005	<sup>5)</sup>	≤0.012	4.00÷6.00	≤0.30	0.45÷0.65	–	≤0.30	–	–	–
13CrMoV9-10	0.11÷0.15	≤0.10	0.30÷0.60	0.015	0.005	<sup>5)</sup>	≤0.012	2.00÷2.50	≤0.20	0.90÷1.10	≤0.07	≤0.25	0.03	0.25÷0.35	≤0.002B ≤0.015Ca
12CrMoV12-10	0.10÷0.15	≤0.15	0.30÷0.60	0.015	0.005	<sup>5)</sup>	≤0.012	2.75÷3.25	≤0.25	0.90÷1.10	≤0.07 <sup>8)</sup>	≤0.25	0.03 <sup>8)</sup>	0.20÷0.30	≤0.002B <sup>8)</sup> ≤0.015Ca <sup>8)</sup>
X10CrMoVNb9-1	0.08÷0.12	≤0.50	0.30÷0.60	0.020	0.005	≤0.04	0.03÷0.07	8.00÷9.50	≤0.30	0.85÷1.05	0.06÷0.10	≤0.30	–	0.18÷0.25	–

- <sup>1)</sup> Elements not indicated in this table shall not be intentionally added to the steel without the orderer's consent except for the elements used for the cast finishing. Reasonable countermeasures shall be taken against introduction – from scrap or other components used for the steel cast – of such elements which may have adverse effect on mechanical properties or usefulness of the steel.
- <sup>2)</sup> Lower than maximum content of copper and/or maximum total content of copper and tin, e.g. Cu+6 Sn ≤ 0.33%, may be accepted at the offer enquiry, e.g. due to deformability at elevated temperatures, for those steel grades for which the maximum content of copper is specified only.
- <sup>3)</sup> For product thicknesses < 6 mm, manganese content less than 0.20% is permitted.
- <sup>4)</sup> The condition that Al/N ≥ 2 shall be fulfilled.

- 5) Al content in the cast shall be determined and indicated in the *Inspection Certificate*.
- 6) If the material resistance to hydrogen embrittlement is of significant importance, then the minimum chromium content of 0.80% may be accepted at the offer enquiry and order.
- 7) For product thicknesses > 150 mm, the maximum carbon content of 0.17% may be accepted at the offer enquiry and order.
- 8) This grade may be manufactured with the addition of either Ti + B or Nb + Ca. The following minimum content values are permitted:  $\geq 0.015\%$  Ti and  $\geq 0.001\%$  B where Ti + B;  $\geq 0.015\%$  Nb and  $\geq 0.0005\%$  Ca where Nb + Ca.

## 6.4 Mechanical Properties

Mechanical properties at room temperature and the yield stress at elevated temperature of steel for boilers and pressure vessels, determined on transverse specimens, shall fulfil the requirements specified in Table 6.4-1 and Table 6.4-2.

Mechanical properties of rolled steels exceeding 60 mm in thickness as well as 1% creep limit and creep strength shall fulfil the requirements specified in standard PN-EN 10028-2.

**Table 6.4-1**  
**Mechanical properties (transverse specimens) <sup>1)</sup>**

Steel grade	Regular supply condition <sup>2)</sup>	Product thickness $t$ [mm]	Tensile test at ambient temperature			Impact energy $KV$ [J] min. at temperature		
			$R_e$ [MPa] min.	$R_m$ [MPa]	$A$ [%]	-20 [°C]	0 [°C]	+20 [°C]
P235GH	N <sup>3)</sup>	$\leq 16$	235	360÷480	24	27	34	40
		$16 < t \leq 40$	225					
		$40 < t \leq 60$	215					
P265GH	N <sup>3)</sup>	$\leq 16$	265	410÷530	22	27	34	40
		$16 < t \leq 40$	255					
		$40 < t \leq 60$	245					
P295GH	N <sup>3)</sup>	$\leq 16$	295	460÷580	21	27	34	40
		$16 < t \leq 40$	290					
		$40 < t \leq 60$	285					
P355GH	N <sup>3)</sup>	$\leq 16$	355	510÷650	20	27	34	40
		$16 < t \leq 40$	345					
		$40 < t \leq 60$	335					
16Mo3	N <sup>4)</sup>	$\leq 16$	275	440÷490	22	5)	5)	31
		$16 < t \leq 40$	270					
		$40 < t \leq 60$	260					
18MnMo4-5	NT	$\leq 60$	345	510÷650	20	27	34	40
20MnMoNi4-5	QT	$\leq 40$	470	590÷750	18	27	40	50
		$40 < t \leq 60$	460	590÷730				
15NiCuMoNb5-6-4	NT	$\leq 60$	460	610÷780	16	27	34	40
		$40 < t \leq 60$	440					
13CrMo4-5	NT	$\leq 16$	300	610÷780	19	5)	5)	31
		$16 < t \leq 60$	290					
13CrMoSi5-5	NT	$\leq 60$	310	510÷690	20	5)	27	34
	QT	$\leq 60$	400	510÷690		27	34	40
10CrMo9-10	NT	$\leq 16$	310	480÷630	18	5)	5)	31
		$16 < t \leq 40$	300					
		$40 < t \leq 60$	290					
12CrMo9-10	NT lub QT	$\leq 250$	355	540÷690	18	27	40	70
X12CrMo5	NT	$\leq 60$	320	510÷690	20	27	34	40
13CrMoV9-10	NT	$\leq 60$	455	600÷780	18	27	34	40
12CrMoV12-10	NT	$\leq 60$	455	600÷780	18	27	34	40
X10CrMoVNb9-1	NT	$\leq 60$	445	580÷760	18	27	34	40



- 1) For product thicknesses > 60 mm (except for grade 12CrMo9-10) the property values are subject to PRS acceptance in each particular case.
- 2) For product thicknesses for which regular supply condition is NT, tensile strength and impact energy values may be higher for QT supply condition subject to PRS acceptance in each particular case.
- 3) See paragraph 6.5.2.
- 4) At the manufacturer's discretion, this steel may be supplied also in NT supply condition.
- 5) This value may be agreed at the offer enquiry and ordering.

**Table 6.4-2**  
**Minimum values of proof stress  $R_{p0.2}$  at elevated temperatures**  
**for product thicknesses up to 60 mm <sup>1)</sup>**

Steel grade	Product thickness <sup>2,3)</sup> $t$ [mm]	$R_{p0.2}$ [MPa] min. at temperature [°C]									
		50	100	150	200	250	300	350	400	450	500
P235GH	$\leq 16$	227	214	198	182	167	153	142	133	–	–
	$16 < t \leq 40$	218	205	190	174	160	147	136	128	--	–
	$40 < t \leq 60$	208	196	181	167	153	140	130	122	–	–
P265GH	$\leq 16$	256	241	223	205	188	173	160	150	–	–
	$16 < t \leq 40$	247	232	215	197	181	166	154	145	–	–
	$40 < t \leq 60$	237	223	206	190	174	160	148	139	–	–
P295GH	$\leq 16$	285	268	249	228	209	192	178	167	–	–
	$16 < t \leq 40$	280	264	244	225	206	189	175	165	–	–
	$40 < t \leq 60$	276	259	240	221	202	186	172	162	–	–
P355GH	$\leq 16$	343	323	299	275	252	232	214	202	–	–
	$16 < t \leq 40$	334	314	291	267	245	225	208	196	–	–
	$40 < t \leq 60$	324	305	282	259	238	219	202	190	–	–
16 Mo3	$\leq 16$	273	264	250	233	213	194	175	159	147	141
	$16 < t \leq 40$	268	259	245	228	209	190	172	156	145	139
	$40 < t \leq 60$	258	250	236	220	202	183	165	150	139	134
18MnMo4-5	$\leq 60$	330	320	315	310	295	285	265	235	215	–
20MnMoNi4-5	$\leq 40$	460	448	439	432	424	415	402	384	–	–
	$40 < t \leq 60$	450	438	430	423	415	406	394	375	–	–
15NiCuMoNb5-6-4	$\leq 40$	447	429	415	403	391	380	366	351	331	–
	$40 < t \leq 60$	427	410	397	385	374	363	350	335	317	–
13CrMo4-5	$\leq 16$	294	285	269	252	234	216	200	186	175	164
	$16 < t \leq 60$	285	275	260	243	226	209	194	180	169	159
13CrMoSi5-5 (NT)	$\leq 60$	299	283	268	255	244	233	223	218	206	–
10CrMo9-10	$\leq 16$	288	266	254	248	243	236	225	212	197	185
	$16 < t \leq 40$	279	257	246	240	235	228	218	205	191	179
	$40 < t \leq 60$	270	249	238	232	227	221	211	198	185	173
12CrMo9-10	$\leq 60$	341	323	311	303	298	295	292	287	279	–
X12CrMo5	$\leq 60$	310	299	295	294	293	291	285	273	253	222
13CrMoV9-10	$\leq 60$	410	395	380	375	370	365	362	360	350	–
12CrMoV12-10	$\leq 60$	410	395	380	375	370	365	362	360	350	–
X10CrMoVNb9-1	$\leq 60$	432	415	401	392	385	379	373	364	349	324

- 1) The data correspond to the lower region of the particular curve-belt determined in accordance with standard EN 10314 within the confidence interval around 98% (2s).
- 2) For product thicknesses exceeding the specified maximum values, the values of  $R_{p0.2}$  at elevated temperatures are subject to PRS acceptance in each particular case.
- 3) Supply condition is specified in Table 6.4-1 (see also Note 3 to Table 6.4-1).

## 6.5 Supply Condition

**6.5.1** Supply condition of rolled steel for product thicknesses not exceeding 60 mm shall fulfil the requirements specified in Table 6.5.1 and shall be stated in the Inspection Certificate. Supply condition of rolled steel for product thicknesses exceeding 60 mm are specified in standard PN-EN 10028-2.

**6.5.2** For unalloyed quality steels, normalising rolling may be substituted for normalising.

**6.5.3** Unalloyed quality steel products may be supplied also in AR supply condition subject to PRS acceptance in each particular case.

**6.5.4** Critical time temperature parameter  $P_{cri}$  and possible combinations of stress relieving temperature and holding time shall be determined in accordance with standard PN-EN 10028-2.

**Table 6.5.1**  
**Supply condition for steels for boilers and pressure vessels**

Category of steels	Steel grade	Regular supply condition
Unalloyed quality steels	P235GH	N <sup>1)</sup>
	P265GH	
	P295GH	
	P355GH	
Special purpose alloy steels	16Mo3	N <sup>2)</sup>
	18MnMo4-5	NT
	20MnMoNi4-5	QT
	15NiCuMoNb5-6-4	NT
	13CrMo4-5	NT
	13CrMoSi5-5	NT, QT
	10CrMo9-10	NT, QT
	12CrMo9-10	NT, QT
	X12CrMo4	NT
	13CrMoV9-10	NT
	12CrMoV12-10	NT
X10CrMoVNb9-1	NT	

<sup>1)</sup> See paragraph 6.5.2.

<sup>2)</sup> At the manufacturer's discretion, the steel may be supplied also in NT supply condition.

## 6.6 Testing

### 6.6.1 General Requirements

Each single plate shall be subjected to testing.

Unless provided otherwise, samples shall be taken in accordance with the requirements specified in sub-chapter 3.9 of this *Part*.

Tensile and impact tests specimens shall be so cut that their axes be perpendicular to the final direction of rolling (transverse specimens).

### 6.6.2 Mandatory Testing

The following tests shall be performed:

- tensile test at temperature +20°C,
- impact test,

- dimensions' check,
- surface condition visual examination.

### 6.6.3 Additional Testing

The following tests may be performed subject to order specification:

- tensile test at elevated temperature to determine  $R_{p0.2}^t$ ,
- chemical analysis,
- through thickness tensile test (see Chapter 5 of this *Part*),
- ultrasonic testing.

### 6.6.4 Tensile Test at Ambient Temperature

For unalloyed steel plates with thickness not exceeding 50 mm, one sample shall be taken from each rolled length.

For unalloyed steel plates with more than 50 mm in thickness, one sample shall be taken from one end when the rolled length does not exceed 15 m or test specimens shall be taken from both ends when the rolled length exceeds 15 m.

For alloyed steel plates, one specimen shall be taken from one end if the rolled length does not exceed 7 m or test specimens shall be taken from both ends if the rolled length exceeds 7 m.

The test shall be performed in accordance with the requirements specified in sub-chapter 2.5 of this *Part*.

### 6.6.5 Tensile Test at Elevated Temperature

Proof stress shall be determined in accordance with standard PN-EN ISO 6892-2.

Proof stress shall be determined on one specimen taken from each cast, at the temperature specified in the order. Where the temperature has not been specified, the test shall be performed at the temperature of 300°C.

### 6.6.6 Impact Test

Impact test shall be performed in accordance with the requirements specified in sub-chapter 2.6 of this *Part*.

Rolled products with a thickness of 5 mm and above shall be subjected to an impact test at temperature specified in Table 6.4-1. A set of Charpy V-notch specimens (3 specimens) shall be taken as specified in sub-chapter 6.6.1 for tensile test.

### 6.6.7 Other Tests

Where ultrasonic testing has been agreed for plates with a thickness of 6 mm and above to check the product internal quality, the requirements specified in standard PN-EN 10160 apply.

Other testing (e.g. material resistance to hydrogen embrittlement, brittleness testing of steel CrMo) shall be performed in accordance with standard PN-EN 10028-2.

## 6.7 Inspection of Surface and Work Quality

**6.7.1** Surface inspection and verification of dimensions are the responsibility of the steelmaker, and acceptance by PRS Surveyor of material later found to be defective shall not absolve the steelmaker of this responsibility.

**6.7.2** The surface of the plates shall be smooth and clean, free from cracks, pulls, laminations, scales, inclusions.

**6.7.3** Plate surface defects due to the method of manufacture are permitted, provided their depth does not exceed the thickness tolerances specified in the applicable standard (e.g. PN-EN 10029).

**6.7.4** Repair of defects by welding is permitted subject to PRS consent in each particular case.

**6.7.5** All products shall be submitted to PRS Surveyor for final inspection and check.

## **6.8 Marking**

Material marking shall be performed in accordance with the requirements specified in sub-chapter 1.9 of this *Part*.

## **6.9 Inspection Certificate**

For all approved steels, PRS issues *Inspection Certificate* in accordance with the requirements specified in sub-chapter 1.8 of this *Part*.

---

## **7 STEEL FOR LOW TEMPERATURE SERVICE**

### **7.1 Steel for Hull Structures**

Steels intended for hull structures exposed to low temperatures shall fulfil the requirements specified in Chapter 3 of *Part IX*.

The principles of steel selection for particular hull elements are specified in *Part II – Hull*.

### **7.2 Steels for Construction of Liquefied Gas Tankers**

Steel plates, sections, tubes, forgings, castings and welded structures used in the construction of cargo tanks, pressure vessels, processing tanks, cargo and processing pipelines, secondary barriers and the adjacent structures intended for the carriage of liquefied gases shall fulfil the requirements specified in *Publication 48/P – Requirements Concerning Gas Tankers*.

High manganese austenitic steel used for construction of cargo and fuel tanks of LNG carriers and LNG-fuelled ships shall fulfil the requirements specified in the *Interim Guidelines on the Application of High Manganese Austenitic Steel for Cryogenic Service* (IMO MSC.1/Circ. 1599/Rev. 2).

### **7.3 Steels for Other Structures**

Steels intended for low temperature service structures, other than those specified in 7.1 and 7.2, are subject to PRS acceptance in each particular case.

## 8 STAINLESS STEELS

### 8.1 General Requirements

The requirements specified in the present Chapter apply to weldable austenitic and duplex stainless steel plates, flats, bars and sections with a thickness of up to 50 mm, intended for construction of hull structures and tanks for the carriage of chemicals.

In respect of chemical composition, these requirements are also applicable to the clad steels (see Chapter 9 of this Part).

Application of steel, the chemical composition and mechanical properties of which do not fulfil the present requirements, as well as the use of other stainless steels complying with the relevant standards are subject to PRS acceptance in each particular case.

Austenitic steels may be used for applications where the design temperature is not less than  $-165^{\circ}\text{C}$ .

### 8.2 Chemical Composition

The chemical composition of austenitic and duplex stainless steels in ladle analysis shall fulfil the requirements specified in Table 8.2.

**Table 8.2**  
**Chemical composition of austenitic and duplex stainless steels**

Steel grade		Chemical composition [%]								
designation <sup>1)</sup>	acc. to AISI	C max	Si max	Mn max	P max	S max	Cr	Ni	Mo	Others
<b>Austenitic steels</b>										
X2CrNi19-11	304L	0.030	1.0	2.0	0.045	0.015	18÷20	10÷12		$N \leq 0.11$
X2CrNiMo17-12-2	316L	0.030	1.0	2.0	0.045	0.015	16.5÷18.5	10÷13	2.0÷2.5	$N \leq 0.11$
X2CrNiMo17-13-3	316LN	0.030	1.0	2.0	0.045	0.015	16.5÷18.5	11÷14	2.5÷3.0	$0.12 \leq N \leq 0.22$
X2CrNiMo18-15-4	317L	0.030	1.0	2.0	0.045	0.015	17.5÷19.5	13÷16	3.0÷4.0	$N \leq 0.11$
-	317LN	0.030	1.0	2.0	0.045	0.015	18÷20	12.5÷15.0	3.0÷4.0	$0.14 \leq N \leq 0.22$
X6CrNiTi18-10	321	0.08	1.0	2.0	0.045	0.015	17÷19	9÷12	-	$5xC \leq Ti \leq 0.70$
X6CrNiNb18-10	347	0.08	1.0	2.0	0.045	0.015	17÷19	9÷12	-	$10xC \leq Nb \leq 1.0$
<b>Duplex steels</b>										
X2CrNiMoN22-5-3	S31803	0.030	1.0	2.0	0.035	0.015	21÷23	4.5÷6.5	2.5÷3.5	$0.10 \leq N \leq 0.22$
X2CrNiMoN25-7-4	S32750	0.030	1.0	2.0	0.035	0.015	24÷26	6÷8	3.0÷4.5	$0.24 \leq N \leq 0.35$

<sup>1)</sup> According to PN-EN 10088-1.

### 8.3 Mechanical Properties

Mechanical properties of austenitic and duplex stainless steels shall fulfil the requirements specified in Table 8.3. For austenitic steels, the impact test is required where the design temperature is lower than  $-105^{\circ}\text{C}$ .

For duplex steels, the impact test is required where the design temperature is lower than  $-20^{\circ}\text{C}$ .

### 8.4 Supply Condition

Unless otherwise specified in the order, the products from austenitic and duplex stainless steels shall be supplied in the as solution treatment condition, and their surface shall be etched.

**Table 8.3**  
**Mechanical properties of austenitic and duplex stainless steels in solution treatment condition**

Steel grade		Product form <sup>1)</sup>	Thickness max. [mm]	Tensile test				Impact test for thicknesses $t \geq 10$ mm		
signation	acc to AISI			$R_{p0.2}$ min. [MPa]	$R_{p1.0}$ min. [MPa]	$R_m$ min. [MPa]	$A$ min. [%]	$t$ [°C]	$KV_L^{2)}$ [J] min.	$KV_T^{2)}$ [J] min.
<b>Austenitic steels</b>										
X2CrNi19-11	304L	C	8	220	250	520÷700	45	-196	-	-
		H	13,5	200	240				100	60
		P	75	200	240	500÷ 700			-	-
X2CrNiMo17-12-2	316L	C	8	240	270	530÷ 680	-		-	
		H	13.5	220	260		100		60	
		P	75	220	260	520÷ 670	-		-	
X2CrNiMo17-13-3	316LN	C	8	300	330	580÷ 780	35		-	-
		H	13.5	280	320		100		60	
		P	75	280	320	40	-		-	
X2CrNiMo18-15-4	317L	C	8	240	270	550÷ 700	35		-	-
		H	13.5	220	260		100	60		
		P	75	220	260	520÷ 720	40	-	-	
-	317LN	P	50	300	340	520÷ 720	40	41	27	
X6CrNiTi18-10	321	C	8	220	250	520÷ 720	40	-	-	
		H	13.5	200	240			100	60	
		P	75	200	240	500÷ 700		-	-	
X6CrNiNb18-10	347	C	8	220	250	520÷ 720	40	-	-	
		H	13.5	200	240			100	60	
		P	75	200	240	500÷ 700		-	-	
<b>Duplex steels</b>										
X2CrNiMoN22-5-3	S31803	C	8	500	-	700÷ 950	20	+20	-	-
		H	13.5	460	-		25		100	60
		P	75	460	-	640÷ 840	25		-	-
X2CrNiMoN25-7-4	S32750	C	8	550	-	750÷ 1000	20		-	-
		H	13.5	530	-				100	60
		P	75	530	-	730÷ 930			-	-

Notes:

- 1) C – cold rolled strips, H – hot rolled strips, P – hot rolled plates.
- 2)  $KV_L$  – impact energy value for longitudinal specimen,  $KV_T$  – impact energy value for transverse specimen.

## 8.5 Testing

Each plate (length) shall be subjected to testing after heat treatment in accordance with the requirements specified in Chapter 2 of this Part. Chemical analysis and tensile test shall be performed. If specified in the order, testing specified in sub-chapters 8.5.3 ÷ 8.5.5 shall be performed.

Testing mentioned in sub-chapters 8.5.1 and 8.5.2 are mandatory, while those mentioned in sub-chapters 8.5.3, 8.5.4 and 8.5.5 are mandatory only where they have been agreed in the order specifications.

### 8.5.1 Chemical Analysis

Chemical composition shall be determined on the basis of the ladle analysis of specimens taken from each cast. PRS Surveyor may require that the results of the analysis should be checked.

### 8.5.2 Tensile Test

From each batch subjected to testing, at least one tensile test specimen shall be taken. A batch consists of:

- for plates with a thickness over 10 mm: each piece;
- for plates supplied in rolls: each roll, the specimens being taken from both ends of the roll;
- other products: the products made from one cast, of the same shape and dimensions, the same supply condition and the same surface finishing – in the amount not exceeding 10 tonnes.

In the case of plates or wide flats with a thickness over 600 mm, the specimens shall be cut with their axes transverse to the direction of rolling. For other products, the specimens, at the manufacturer's discretion, may be taken in transverse or longitudinal direction.

### 8.5.3 Impact Test

Impact test shall be performed in accordance with the requirements specified in sub-chapter 8.3 and where specially requested by the purchaser. Impact test shall be performed on three Charpy V-notch specimens.

### 8.5.4 Intergranular Corrosion Resistance Test

This test shall be performed on at least two specimens, taken from two different products of each cast.

Laboratory tests of intergranular corrosion resistance of stainless steel shall be performed on the basis of the relevant standards (e.g. ASTM A262-02, PN-EN ISO 3651-1, PN-EN ISO 3651-2).

Specimens taken from Ti stabilized steels and steels with the content of C  $\leq$  0.03% shall be tested after heat treatment (annealed at the temperature of 700°C for 30 minutes and quenched in water).

Specimens from other steels shall be tested in the as supplied condition.

### 8.5.5 Other Tests

If specified in the order, other tests shall be performed, e.g. tensile test at elevated temperature, hardness test, etc.

#### 8.5.5.1 Test of corrosion resistance of steel on simulated upper deck conditions

The test is performed to confirm corrosion resistance of steel used as an alternative means of corrosion protection for cargo oil tanks of crude oil tankers according to the IMO Resolution MSC.289(87).



### 8.5.5.1.1 Test conditions

Tests of corrosion resistance on simulated upper deck conditions in cargo oil tank shall satisfy each of the following conditions:

- .1 Corrosion resistant steel and conventional steel shall be tested at the same time.
- .2 The chemical composition of conventional steel shall comply with the requirements of table 8.5.5.1.1. The mechanical properties of the test specimen shall be representative of steel used in its intended shipboard application.

**Table 8.5.5.1.1**

C	Mn	Si	P	S	Al (acid soluble) min.	Nb max	V max	Ti max	Cu max	Cr max	Ni max	Mo max	others
0.13÷ 0.17	1.00÷ 1.20	0.15÷ 0.35	0.010÷ 0.020	0.002÷ 0.006	0.015	0.02	0.10	0.02	0.1	0.1	0.1	0.02	each max 0.02
						combined max 0.12							

- .3 The tests of corrosion resistant steel shall be performed for 21, 49, 77 and 98 days. The tests for conventional steel shall be performed for 98 days. The tests of welded joints shall be performed for 98 days.
- .4 There shall be five test pieces for each test period.
- .5 The size of each test piece is  $25 \pm 1$  mm  $\times$   $60 \pm 1$  mm  $\times$   $5 \pm 0.5$  mm. The surface of the test piece shall be polished with an emery paper #600. The size of the test piece for a welded joint is  $25 \pm 1$  mm  $\times$   $60 \pm 1$  mm  $\times$   $5 \pm 0.5$  mm, including  $15 \pm 5$  mm width of the weld metal part, according to fig. 8.5.5.1.1-1.

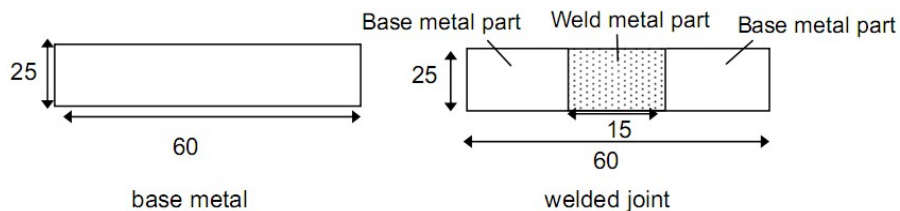

Fig. 8.5.5.1.1-1.

Dimensions of test pieces for the test of corrosion resistance of steel on simulated upper deck conditions

- .6 The surface of the test piece, except for the tested surface, shall be protected from corrosive environment in order not to affect the test results.
- .7 The test apparatus consists of a double chamber, and the temperature of the outer chamber shall be controlled. The sketch of apparatus is presented in fig. 8.5.5.1.1-2.

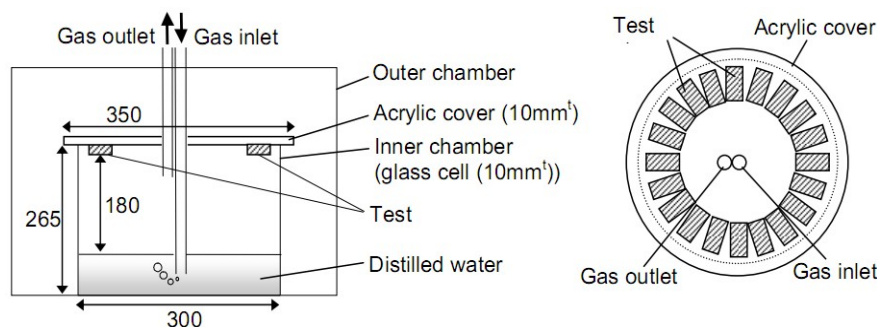

Fig. 8.5.5.1.1-2.

Sketch of apparatus for the test of corrosion resistance of steel on simulated upper deck conditions

- .8 Simulating the condition of the actual upper deck, the test cycle runs with distilled water and simulated crude oil tank gas (4±1% O<sub>2</sub>, 13±2% CO<sub>2</sub>, 100±10 ppm SO<sub>2</sub>, 500±50 ppm H<sub>2</sub>S, 83±2% N<sub>2</sub>). A sufficient distance between the surface of the test piece and the distilled water shall be kept to avoid splashing of distilled water. The minimum gas flow rate is 100 cm<sup>3</sup>/min for the first 24 h and 20 cm<sup>3</sup>/min after 24 h.
- .9 The test pieces shall be heated for 19±2 h at 50±2°C and 3±2 h at 25±2°C and the transition time shall be at least 1 h. The time for 1 cycle is 24 h. The temperature of the distilled water shall be kept at not higher than 36°C, while the temperature of the test pieces is 50°C.

### 8.5.5.1.2 Test results

Prior the testing, the following measured data shall be reported:

- .1 size and weight of the test piece prior to the testing,

After the testing, the following measured data shall be reported:

- .2 weight loss (difference between initial weight and weight after testing) of conventional steel ( $W_c$ ) and corrosion resistant steel ( $W_{21}$ ,  $W_{49}$ ,  $W_{77}$  and  $W_{98}$ ),
- .3 corrosion loss of conventional steel ( $CL_c$ ) and corrosion resistant steel ( $CL_{21}$ ,  $CL_{49}$ ,  $CL_{77}$  and  $CL_{98}$ ), calculated by the following formulae:

$$CL_c = \frac{10 \cdot W_c}{S \cdot D} \text{ [mm]} \quad (8.5.5.1.2.3-1)$$

$$CL_{21} = \frac{10 \cdot W_{21}}{S \cdot D} \text{ [mm]} \quad (8.5.5.1.2.3-2)$$

$$CL_{49} = \frac{10 \cdot W_{49}}{S \cdot D} \text{ [mm]} \quad (8.5.5.1.2.3-3)$$

$$CL_{77} = \frac{10 \cdot W_{77}}{S \cdot D} \text{ [mm]} \quad (8.5.5.1.2.3-4)$$

$$CL_{98} = \frac{10 \cdot W_{98}}{S \cdot D} \text{ [mm]} \quad (8.5.5.1.2.3-5)$$

where:

$W_c$  [g] – weight loss of conventional steel (average of five test pieces),

$W_{21}$  [g] – weight loss of corrosion resistant steel after 21 days (average of five test pieces),

$W_{49}$  [g] – weight loss of corrosion resistant steel after 49 days (average of five test pieces),

$W_{77}$  [g] – weight loss of corrosion resistant steel after 77 days (average of five test pieces),

$W_{98}$  [g] – weight loss of corrosion resistant steel after 98 days (average of five test pieces),

$S$  [cm<sup>2</sup>] – test surface area,

$D$  [g/cm<sup>3</sup>] – density.

The test is considered to be performed appropriately if  $CL_c$  is between 0.05 and 0.11 (corrosion rate is between 0.2 and 0.4 mm/year). The concentration of H<sub>2</sub>S in simulated crude oil tank gas may be increased for adjusting  $CL_c$ .

- .4 coefficients  $A$  and  $B$  of corrosion resistant steel, calculated from the test results for 21, 49, 77 and 98 days by least square method.

Corrosion loss of corrosion resistant steel is described as follows:

$$CL = A t^B \text{ [mm]} \quad (8.5.5.1.2.4)$$

$A, B$  – coefficients [mm]

$t$  – test period [days].

- .5 estimated corrosion loss after 25 years ( $ECL$ ) calculated by the following formula:

$$ECL = A \cdot (25 \cdot 365)^B \text{ [mm]}$$

### 8.5.5.1.3 Test results of welded joint

The surface boundary between base metal and weld metal shall be photographed by microscope at 1,000 times magnification.

### 8.5.5.1.4 Acceptance criteria

The test results shall satisfy the following criteria:

- .1 for base metal –  $ECL \leq 2$  mm,
- .2 for welded joint – no discontinuous surface (e.g. step) between the base metal and weld metal.

### 8.5.5.1.5 Test report

The test report shall include the following information:

- .1 name of the manufacturer,
- .2 date of tests,
- .3 chemical composition and corrosion resistant process of steel,
- .4 test results according to 8.5.5.1.2 and 8.5.5.1.3,
- .5 judgement according to 8.5.5.1.4.

## 8.5.5.2 Test of corrosion resistance of steel on simulated inner bottom conditions

The test is performed to confirm corrosion resistance of steel used as an alternative means of corrosion protection for cargo oil tanks of crude oil tankers according to the IMO Resolution MSC.289(87).

### 8.5.5.2.1 Test conditions

Tests of corrosion resistance on simulated inner bottom conditions in cargo oil tanks shall satisfy each of the following conditions:

- .1 The test shall be performed for 72 h for base metal, and 168 h for welded joint.
- .2 There shall be at least five test pieces of corrosion resistant steel for base metal and welded joint, respectively. For comparison, at least five test pieces of base metal of conventional steel should be tested in the same conditions.
- .3 The size of each test piece is  $25 \pm 1$  mm x  $60 \pm 1$  mm x  $5 \pm 0.5$  mm for a specimen with base metal only, and is  $25 \pm 1$  mm x  $60 \pm 1$  mm x  $5 \pm 0.5$  mm for a specimen with welded joint, including  $15 \pm 5$  mm width of weld metal part, as shown in Fig. 8.5.2.1-1. The surface of the test piece shall be polished with an emery paper #600, except a hole for hanging.

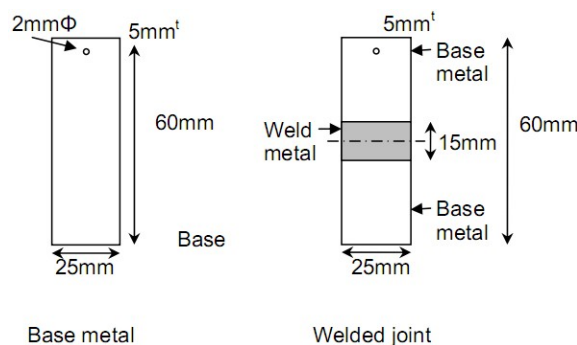

Fig. 8.5.5.2.1-1.

Test piece sizes for the test of corrosion resistance of steel on simulated inner bottom conditions

- .4 The samples shall be hung in a solution from a fishing line (0.3-0.4 mm in diameter) made of nylon. A sketch of a corrosion test configuration is shown in Fig. 8.5.5.2.1-2.

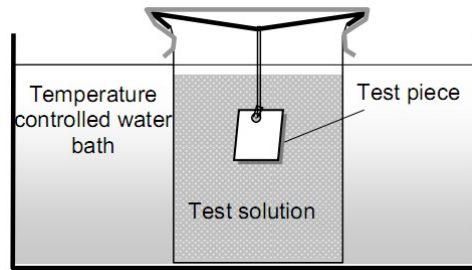

Fig. 8.5.5.2.1-2.

Sketch of apparatus for the test of corrosion resistance of steel on simulated inner bottom conditions

- .5 The test solution contains 10% NaCl and its pH is 0.85 adjusted by HCl solution. The test solution should be changed to a new one every 24 h to minimize pH change of the test solution. The volume of the solution is more than 20 cm<sup>3</sup> per cm<sup>2</sup> of surface area of test piece. The temperature of the test solution shall be kept at 30±2°C.

**8.5.5.2.2 Test results**

Prior to the testing, the following data shall be measured and reported:

- .1 size and weight of the test piece prior to the testing,

After the testing, the following measured data shall be reported:

- .2 weight loss (difference between initial weight and weight after testing),
- .3 corrosion rate (*CR*) calculated by the following formula:

$$CR = \frac{365 \cdot 24 \cdot W \cdot 10}{S \cdot 72 \cdot D} [\text{mm/year}],$$

where:

- W* [g] – weight loss,
- S* [cm<sup>2</sup>] – surface area,
- D* [g/cm<sup>3</sup>] – density.

- .4 To identify specimens which hold crevice and/or localized corrosion, the *CR* shall be plotted on a normal distribution statistic chart (Fig. 8.5.5.2.2). *CR* values which deviate from the normal statistical distribution shall be eliminated from the test results.
- .5 Calculation of average value of *CR* – *CR<sub>ave</sub>*.

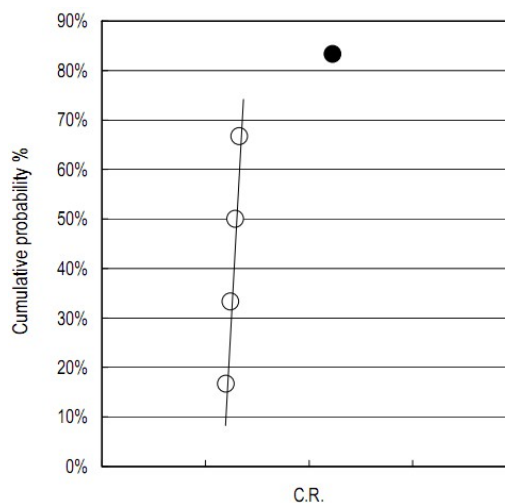

Fig. 8.5.5.2.2.

Example of a *CR* value chart on a normal distribution statistic chart.  
The value marked with ● shall be abandoned and eliminated.

### 8.5.5.2.3 Test results of welded joint

The surface boundary between base metal and weld metal shall be photographed by microscope\_ at 1,000 times magnification.

### 8.5.5.2.4 Acceptance criteria

The test results shall satisfy the following criteria:

- .1 for base metal –  $CR_{ave} \leq 1.0$  mm/year,
- .2 for welded joint – no discontinuous surface (e.g. step) between the base metal and weld metal.

### 8.5.5.2.5 Test report

The test report shall include the following information:

- .1 name of the manufacturer,
- .2 date of test,
- .3 chemical composition and corrosion resistant process of steel,
- .4 test results according to 8.5.5.2.2 and 8.5.5.2.3,
- .5 judgement according to 8.5.5.2.4.

## 8.6 Inspection of Surface and Work Quality

Surface inspection, verification of dimensions of the finished products, as well as internal defects are the responsibility of the manufacturer.

Final tests performed in the presence of PRS Surveyor do not absolve the manufacturer from this responsibility.

Both sides of plates and other products shall be subjected to 100% visual inspection by the manufacturer.

Under thickness tolerances are not permitted. Dimension tolerances of sections shall fulfil the requirements specified in the relevant standards.

Minor surface defects may be removed by grinding. The plate thickness after grinding, however, shall not be less than the nominal thickness.

Repair of major defects is subject to PRS acceptance in each particular case. PRS may require that the product quality should be checked by non-destructive method, e.g. ultrasonic testing.

## 8.7 Marking

Products shall be marked in accordance with the requirements specified in sub-chapter 1.9 of this *Part*.

## 8.8 Inspection Certificate

*Inspection Certificate*, in addition to the particulars required in sub-chapter 1.8 of this *Part*, shall contain the following information:

- .1 for austenitic steels: the values of both  $R_{p0.2}$  and  $R_{p1.0}$ ,
- .2 results of all the tests specified in the order.

## 9 CLAD STEELS

### 9.1 General Requirements

The requirements specified in the present Chapter apply to clad steel plates used for construction of hull and tanks intended for the carriage of chemicals.

Clad plate consists of a base material and a thinner layer (cladding material) on one or both sides, continuously and integrally bonded. Joining shall be done by roll cladding, explosive bonding or a combination of both.

The minimum thickness of the cladding metal shall be 1.5 mm, however it is subject to PRS acceptance in each particular case.

Permissible dimension tolerances, the plate straightness, as well as permissible thickness tolerances of the cladding metal shall fulfil the requirements specified in the relevant standards or in the accepted order specifications.

### 9.2 Chemical Composition

Chemical composition of a base material intended for hull structural parts shall fulfil the requirements for hull structural steels.

Chemical composition of a base material intended for tanks not forming structural part of hull is subject to PRS acceptance in each particular case.

Unless agreed otherwise, austenitic stainless steel complying with the requirements specified in Chapter 8 of this Part shall be used as the cladding metal.

PRS Surveyor may require that check analysis of chemical composition of both the base and cladding materials should be performed.

### 9.3 Mechanical Properties

Mechanical properties of clad plates tested on specimens taken from plates in the supply condition shall fulfil the requirements for the base material.

### 9.4 Supply Condition

Unless otherwise agreed, clad plates of austenitic stainless steel shall be supplied in normalized condition.

### 9.5 Testing

#### 9.5.1 Testing Conditions

If the base material is a hull structural steel, every fifth plate shall be tested and the following conditions shall be fulfilled:

- base material shall be from the same heat,
- cladding material shall be of the same grade,
- nominal thickness of the plates shall be the same,
- plates shall be in the same condition of supply.

Where these conditions cannot be met or where the base material is the steel of Grade E, EH32, EH36 or EH40 or the steel intended for boilers – each strip of plate shall be tested prior to cutting it into sheets.

Location of test specimens shall be in accordance with the general provisions specified in the present Part of the *Rules* for the base material.

The distance of the specimen from the flame or shear cut edge shall in no case be less than 25 mm.

### 9.5.2 Tensile Test

Tensile test shall be performed on a flat proportional specimen cut out from the hull thickness plate. Tensile strength shall be specified in accordance with the formula below:

$$R_m = \frac{R_{m1} \cdot t_1 + R_{m2} \cdot t_2}{t_1 + t_2} \quad [\text{MPa}] \quad (9.5.2)$$

where:

- $R_{m1}$  – minimum tensile strength of base material, [MPa];
- $R_{m2}$  – minimum tensile strength of cladding metal, [MPa];
- $t_1$  – thickness of base material, [mm];
- $t_2$  – thickness of cladding, [mm].

### 9.5.3 Shear Test

Shear test (checking the shear strength between the base and cladding materials) shall be performed on one transverse specimen.

The testing procedure, as well as the specimen dimensions are shown in Fig. 9.5.3. Unless otherwise agreed, the minimum shear strength shall be 140 MPa.

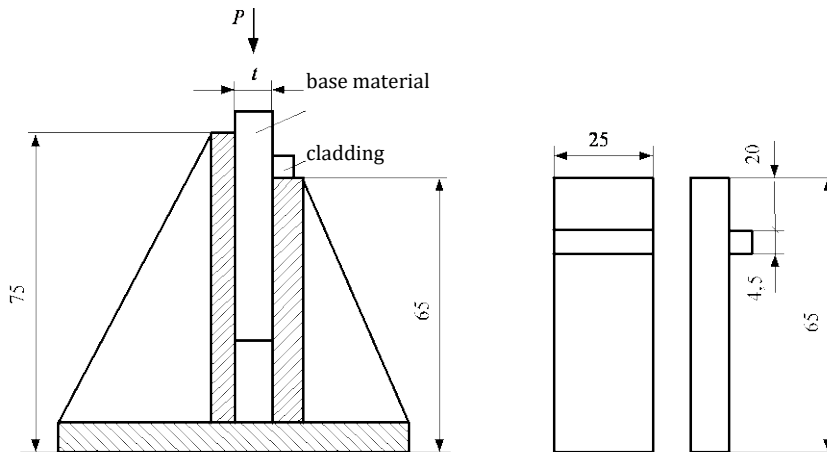

Fig. 9.5.3

### 9.5.4 Bend Test

Bending test shall be performed on two transverse specimens.

The specimens shall be bent 180° around a former having the diameter:

$$D = 2 t \text{ for } R_m \leq 490 \text{ MPa,}$$

$$D = 3 t \text{ for } R_m > 490 \text{ MPa,}$$

where:  $R_m$  – strength of base material.

One specimen shall be bent with base metal in tension; the other specimen – with the cladding in tension.

### 9.5.5 Intergranular Corrosion Resistance Test

Unless otherwise agreed, intergranular corrosion resistance test shall be performed on a specimen taken from each heat in accordance with the requirements of standard ASTM A 262 Practice E or other equivalent standard, e.g. PN-EN ISO 3651-1, PN-EN ISO 3651-2.

### 9.5.6 Impact Test

If impact tests are required, a set consisting of three specimens shall be taken from the base material in accordance with the requirements for base material specified in the present Part of the *Rules*.

### 9.5.7 Non-destructive Testing

To check the bonding, ultrasonic testing of each plate shall be made performed.

The area adjacent to the edges of each plate shall be checked 100% for a width of 50 mm. Further tests shall be conducted at points equally distributed on the surface with max. intervals of 150 mm.

Approval criteria for clad plates are subject to PRS acceptance in each particular case.

### 9.6 Inspection of Surface and Work Quality

Both surfaces of the clad plates shall be even and clean, free from scabs, laps, scales, pitting, cracks, skin holes, chamotting and visible traces of corrosion.

Small indentations after the scale dropping off, scratches, pitting and machining traces may be permitted, provided their depth does not exceed the following:

- 0.2 mm: for the cladding surface,
- negative tolerance on the plate thickness – for base material surface.

Bonding defects<sup>1)</sup> may be accepted without repair, provided that:

- any single bonding defect does not exceed 0.5 dm<sup>2</sup>,
- total area of bonding defects does not exceed 2% of the plate surface,
- defects do not impair the tank structural strength.

Bonding defects in the area adjacent to the edges of the plate for a width of 50 mm are not, in general, permissible. However, if such defects occur, they may be repaired by welding. Details of the repair are subject to PRS acceptance in each particular case.

### 9.7 Marking

The material shall be marked in accordance with the requirements specified in sub-chapter 1.9 of *this Part*.

### 9.8 Inspection Certificate

In addition to the data required in sub-chapter 1.8 of *this Part*, the following information shall be included in the *Inspection Certificate*:

- .1 cast number for both base material and cladding metal,
- .2 product designation (e.g. CLAD PLATE 10x1250x3000 DH32 X6CrNiTi18-10),
- .3 results of all tests agreed in the order.

---

<sup>1)</sup> According to standard PN-H-92140:1979, the term “bonding defects” means areas that are not bonded.



## 10 STEEL TUBES

### 10.1 General Requirements

The requirements specified in the present Chapter apply to hot-rolled steel tubes, cold-drawn or cold-rolled steel tubes, as well as to the welded pipes intended for the manufacture of boilers, pressure vessels, heat exchangers and the ship's piping systems which are subject to PRS survey. Due to their application, these may be either line pipes intended for service at elevated temperatures or structural tubes. Mechanical properties at elevated temperatures have also been specified. The requirements for steels not mentioned in the *Rules* are subject to PRS acceptance in each particular case.

### 10.2 Manufacturing Techniques

Manufacturers of tubes shall be approved by PRS.

Steel tubes shall be manufactured in accordance with the standards or material specifications accepted by PRS.

Seam tubes may be manufactured by welding or they may be electrically welded (induction or resistance welding).

### 10.3 Chemical Composition

Chemical composition of steel intended for tubes determined on the basis of the ladle analysis shall fulfil the requirements specified in Table 10.3. Steel for tubes shall be killed. The use of the semi-killed steel is subject to PRS acceptance in each particular case.

### 10.4 Mechanical Properties

Mechanical properties of steel tubes at the temperature of +20°C and the yield point at elevated temperatures determined on longitudinal specimens shall fulfil the requirements specified in Table 10.4-1 and Table 10.4-2.

Mechanical properties of steel tubes with a wall thickness greater than specified in Table 10.4-2 and the data concerning the creep limit and creep strength shall fulfil the requirements of standard PN-EN 10216-2.

**Table 10.3**  
**Chemical composition (ladle analysis) of steel for tubes as mass percentage**

Steel grade <sup>1)</sup>	C	Si	Mn	P max	S max	Cr	Mo	Ni	Al total	Cu	Nb	Ti max	V max	Others
<b>Line pipes</b>														
P195TR1	≤0.13	≤0.35	≤0.70	0.025	0.020	≤0.30	≤0.08	≤0.30	–	≤0.30	≤0.01	0.04	0.02	–
P235TR1	≤0.16	≤0.35	≤1.20	0.025	0.02	≤0.30	≤0.08	≤0.30	–	≤0.30	≤0.01	0.04	0.02	–
P265TR1	≤0.20	≤0.40	≤1.40	0.025	0.020	≤0.30	≤0.08	≤0.30	–	≤0.30	≤0.01	0.04	0.02	–
<b>Pipes for service at elevated temperatures</b>														
P195GH	≤0.13	≤0.35	≤0.70	0.025	0.020	≤0.30	≤0.08	≤0.30	≤0.02	≤0.30	≤0.01	0.04	0.02	–
P235GH	≤0.16	≤0.35	≤1.20	0.025	0.020	≤0.30	≤0.08	≤0.30	≤0.02	≤0.30	≤0.01	0.04	0.02	–
P265GH	≤0.20	≤0.040	≤1.40	0.025	0.020	≤0.30	≤0.08	≤0.30	≤0.02	≤0.30	≤0.01	0.04	0.02	–
20MnNb6	≤0.22	0.15÷0.35	1.00÷1.50	0.025	0.020	–	–	–	≤0.06	≤0.30	0.015÷0.10	–	–	–
16Mo3	0.12÷0.20	≤0.35	0.40÷0.90	0.025	0.020	≤0.30	0.25÷0.35	≤0.30	≤0.04	≤0.30	–	–	–	–
8MoB5-4	0.06÷0.10	0.10÷0.35	0.60÷0.80	0.025	0.020	≤0.30	0.40÷0.50	–	≤0.06	≤0.30	–	0.06	–	B = 0.002 ÷ 0.006
14MoV6-3	0.10÷0.15	0.15÷0.35	0.40÷0.70	0.025	0.020	0.30÷0.60	0.50÷0.70	≤0.30	≤0.04	≤0.30	–	–	0.22÷0.28	–
10CrMo5-5	≤0.15	0.50÷1.00	0.30÷0.60	0.025	0.020	1.00÷1.50	0.45÷0.65	≤0.30	≤0.04	≤0.30	–	–	–	–
13CrMo4-5	0.10÷0.17	≤0.35	0.40÷0.70	0.025	0.020	0.70÷1.15	0.40÷0.60	≤0.30	≤0.04	≤0.30	–	–	–	–
10CrMo9-10	0.08÷0.14	≤0.50	0.30÷0.70	0.025	0.020	2.00÷2.50	0.90÷1.10	≤0.30	≤0.04	≤0.30	–	–	–	–
11CrMo9-10	0.08÷0.15	≤0.50	0.40÷0.80	0.025	0.020	2.00÷2.50	0.90÷1.10	≤0.30	≤0.04	≤0.30	–	–	–	–
25CrMo4	0.22÷0.29	≤0.40	0.60÷0.90	0.025	0.020	0.90÷1.20	0.15÷0.30	≤0.30	≤0.04	≤0.30	–	–	–	–
20CrMoV13-5-5	0.17÷0.23	0.15÷0.35	0.30÷0.50	0.025	0.020	3.00÷3.30	0.50÷0.60	≤0.30	≤0.04	≤0.30	–	–	0.45÷0.55	–
15NiCuMoNb5-6-4	≤0.17	0.25÷0.50	0.80÷1.20	0.025	0.020	≤0.30	0.25÷0.50	1.00÷1.30	≤0.05	0.50÷0.80	0.015÷0.045	–	–	–
X11CrMo5	0.08÷0.15	0.15÷0.50	0.30÷0.60	0.025	0.020	4.00÷6.00	0.45÷0.65	–	≤0.04	≤0.30	–	–	–	–
X11CrMo9-1	0.08÷0.15	0.25÷1.00	0.30÷0.60	0.025	0.020	8.0÷10.0	0.90÷1.10	–	≤0.04	≤0.30	–	–	–	–
X10CrMoVNb9-1	0.08÷0.12	0.20÷0.50	0.30÷0.60	0.020	0.010	8.0÷9.50	0.80÷1.05	≤0.40	≤0.04	≤0.30	0.06÷0.10	–	0.18÷0.25	N=0.03÷0.07
X20CrMoV11-1	0.17÷0.23	0.15÷0.50	≤1.00	0.025	0.050	10.0÷12.5	0.80÷1.20	0.30÷0.80	≤0.04	≤0.30	–	–	0.25÷0.35	–
<b>Structural tubes</b>														
Hull steels	See Chapter 3 of this Part													

**Table 10.4-1**  
**Mechanical properties of steel tubes**

Steel grade <sup>1)</sup>	Tensile test at ambient temperature						Impact test				
	$R_e$ or $R_{p0.2}$ for wall thicknesses $t$ min. [MPa]			$R_m$ [MPa]	$A$ min. [%]		Impact energy KV [J] min. at temperature °C				
	$t \leq 16$	$16 < t \leq 40$	$40 < t \leq 60$		L	T	L			T	
				20			0	-10	20	0	
<b>Line pipes</b>											
P195TR1	195	185	175	320÷440	27	25	-	-	-	-	-
P235TR1	235	225	215	360÷500	25	23	-	-	-	-	-
P265TR1	265	255	245	410÷570	21	19	-	-	-	-	-
<b>Pipes for service at elevated temperatures</b>											
P195GH	195	-	-	320÷440	27	25	-	40	28	-	27
P235GH	235	225	215	360÷500	25	23	-	40	28	-	27
P265GH	265	255	245	410÷570	23	21	-	40	28	-	27
20MnNb6	355	345	335	500÷650	22	20	-	40	-	-	27
16Mo3	280	270	260	450÷600	22	20	40	-	-	27	-
8MoB5-4	400	-	-	540÷690	19	17	40	-	-	27	-
14MoV6-3	320	320	310	460÷610	20	18	40	-	-	27	-
10CrMo5-5	275	275	265	410÷560	22	20	40	-	-	27	-
13CrMo4-5	290	290	280	440÷590	22	20	40	-	-	27	-
10CrMo9-10	280	280	270	480÷630	22	20	40	-	-	27	-
11CrMo9-10	355	355	355	540÷680	20	18	40	-	-	27	-
25CrMo4	345	345	345	540÷690	18	15	40	-	-	27	-
20CrMoV13-5-5	590	590	590	740÷880	16	14	40	-	-	27	-
15NiCuMoNb5-6-4	440	440	440	610÷780	19	17	40	-	-	27	-
X11CrMo5+I	175	175	175	430÷580	22	20	40	-	-	27	-
X11CrMo5+NT1	280	280	280	480÷640	20	18	40	-	-	27	-
X11CrMo5+NT2	390	390	390	570÷740	18	16	40	-	-	27	-
X11CrMo9-1+I	210	210	210	460÷640	20	18	40	-	-	27	-
X11CrMo9-1+NT	390	390	390	590 ÷740	18	16	40	-	-	27	-
X10CrMoVnb9-1	450	450	450	630÷830	19	17	40	-	-	27	-
X20CrMoN11-1	490	490	490	690÷840	17	14	40	-	-	27	-
<b>Structural tubes</b>											
Hull steels	See Chapter 3 of this Part										

**Table 10.4-2**  
**Minimum proof stress  $R_{p0.2}$  at elevated temperature**

Steel grade	Wall thickness [mm]	Minimum proof stress $R_{p0.2}$ [MPa] at temperature °C										
		100	150	200	250	300	350	400	450	500	550	600
P195GH	≤16	175	165	150	130	113	102	94	-	-	-	-
P235GH	≤60	198	187	170	150	132	120	112	108	-	-	-
P265GH	≤60	226	213	192	171	154	141	134	128	-	-	-
20MnNb6	≤60	312	292	264	241	219	200	186	174	-	-	-
16Mo3	≤60	243	237	224	205	173	159	156	150	146	-	-
8MoB5-4	≤16	368	368	368	368	368	368	368	-	-	-	-
14MoV6-3	≤60	282	276	267	241	225	216	209	203	200	197	-
10CrMo5-5	≤60	240	228	219	208	165	156	148	144	143	-	-
13CrMo4-5	≤60	264	253	245	236	192	182	174	168	166	-	-
10CrMo9-10	≤60	249	241	234	224	219	212	207	193	180	-	-
11CrMo9-10	≤60	323	312	304	296	289	280	275	257	239	-	-
25CrMo4	≤60	-	315	305	295	285	265	225	185	-	-	-
20CrMoV13-5-5	≤60	-	575	570	560	550	510	470	420	370	-	-
15NiCuMoNb5-6-4	≤80	422	412	402	392	382	373	343	304	-	-	-
X11CrMo5+I	≤100	156	150	148	147	145	142	137	129	116	-	-
X11CrMo5+NT1	≤100	245	237	230	223	216	206	196	181	167	-	-
X11CrMo5+NT2	≤100	366	350	334	332	309	299	289	280	265	-	-
X11CrMo9-1+I	≤60	187	186	178	177	175	171	164	153	142	120	-
X11CrMo9-1+NT	≤60	363	348	334	330	326	322	316	311	290	235	-
X10CrMoVNb9-1	≤100	410	395	380	370	360	350	340	320	300	270	215
X20CrMoV11-1	≤100	-	-	430	415	390	380	360	330	290	250	-

## 10.5 Supply Condition

Tubes shall be heat treated if required by other Parts of the *Rules*, standards or documentation approved by PRS. Cold-rolled tubes or cold-drawn tubes, as well as tubes electrically welded shall be submitted to normalising, normalising and tempering or quenching and tempering. Supply condition shall fulfil the requirements specified in Table 10.5. The heat treatment details are established by the manufacturer, reported to PRS and entered in the *Inspection Certificate*.

**Table 10.5**  
**Supply condition for tube steels**

Steel grade	Supply condition
P195TR1, P235TR1, P265TR1	AR
P195TR1, P235TR1, P265TR1, P195GH, P235GH, P265GH, 20MnNb6, 16Mo3, 8MoB5-4	N
14MoV6-3, 10CrMo5-5, 13CrMo4-5, 10CrMo9-10, 15NiCuMoNb5-6-4, X11CrMo5+NT1, X11CrMo5+NT2, X11CrMo9-1+NT, X10CrMoVNb9-1, X20CrMoV11-1	NT
X11CrMo5+I, X11CrMo9-1+I	I
11CrMo9-10, 25CrMo4, 20CrMoV13-5-5	QT

## 10.6 Testing

**10.6.1** Tubes shall be tested in batches. Tubes of the same external diameter and the same wall thickness, of the same cast and submitted to the same heat treatment are regarded as a batch.

**10.6.2** The number of tubes in a batch shall not exceed:

- 400 pieces – with the diameter not greater than 76 mm,
- 200 pieces – with the diameter greater than 76 mm.

When the number of the remaining tubes is less than the half of the amount given above, they shall be considered as the same batch. When the number is greater than the half of the given amount, the tubes shall be considered as a separate batch.

**10.6.3** Each batch of tube shall be submitted to the following tests:

- tensile test (to determine  $R_e$ ,  $R_m$  and  $A$  – in accordance with the requirements specified in sub-chapter 2.5 of *this Part*),
- tensile test at elevated temperature (to determine  $R'_c$ ),
- impact test (in accordance with the requirements specified in sub-chapter 2.6 of *this Part*),
- flattening test (in accordance with the requirements specified in paragraph 2.11.1 of *this Part*) or ring tensile test (in accordance with the requirements specified in paragraph 2.11.3 of *this Part*),
- drift expanding test (in accordance with the requirements specified in paragraph 2.11.2 of *this Part*).

**10.6.4** To perform the required tests, the following test specimens shall be cut from each sample:

- one specimen for the tensile test,
- three specimens for the impact test (for wall thicknesses  $t \geq 12$  mm),
- one specimen for the flattening test or ring tensile test (two specimens in the case of welded tubes; the weld of one of the specimens shall be in the zone of bending during testing),
- one specimen for the drift expanding test.

Unless provided otherwise, samples shall be cut from one end of at least two tubes taken from a batch.

**10.6.5** Tensile test at elevated temperature, impact test, flattening test, ring tensile test or drift expanding test shall be performed if provided by the relevant standards or material specifications – subject to PRS acceptance in each particular case – according to which evaluation of the performed tests results is done.

**10.6.6** All tubes shall to be tested for tightness by hydraulic test. The value of the test pressure shall be assumed in accordance with the standards or the documentation approved by PRS.

Subject to PRS acceptance in each particular case, hydraulic test need not be performed, provided all tubes are submitted to ultrasonic or other non-destructive testing.

All joints of welded pipes shall be submitted to ultrasonic testing.

### **10.7 Inspection of Surface and Work Quality**

Surface inspection and verification of dimensions is the responsibility of the tube manufacturer. The issue, by PRS, of the *Inspection Certificate* does not absolve the manufacturer from this responsibility. Tubes are subject to visual examination and dimensional control for compliance with the relevant standards.

Each tube shall be subjected to visual examination. The surface of the pipes and tubes shall be free from such defects as cracks, pulls and laps.

Single minor cuts, indentations, scratches, thin film of scale and shallow flakes are acceptable, provided they are within the specified dimension tolerances of a product.

### **10.8 Marking**

Steel pipes and tubes shall be marked in accordance with the requirements specified in sub-chapter 1.9 of *this Part*.

### **10.9 Inspection Certificate**

In addition to the data required in sub-chapter 1.8 of *this Part*, the following information shall be included in the *Inspection Certificate*:

- .1 toughness test results,
- .2 hydraulic test results,
- .3 non-destructive test results (if applicable),
- .4 results of other tests agreed in the order,
- .5 heat treatment parameters (if applicable).

## 11 ROLLED STEELS FOR ANCHOR CHAIN CABLES

### 11.1 General Requirements

The requirements of the present Chapter apply to rolled steel used for the manufacture of anchor chain cables and accessories which are subject to PRS survey. Grade 2 and Grade 3 materials are subject to PRS survey.

### 11.2 Manufacturing Procedures

**11.2.1** Materials used for the manufacture of anchor chain cables and accessories shall be supplied by the manufacturers approved by PRS. PRS approval is not required for Grade 1 steel bars. PRS may require mechanical testing of the rolled bars at the steel mill in a heat treatment condition equivalent to that of the finished chain cable. In such cases the properties shall fulfil the requirements specified in Table 20.3.5 of *this Part*.

**11.2.2** Materials suppliers or chain cable manufacturers shall submit specification for Grade 3 steel bars. These specifications shall contain all the necessary details, such as manufacturing procedure, deoxidation practice, specified chemical composition, heat treatment, and mechanical properties for each batch of bars and shall be indicated in the *Inspection Certificate*.

### 11.3 Supply Condition

Unless otherwise specified, rolled steel bars for chain cables may be supplied in as rolled condition.

### 11.4 Chemical Composition

Chemical composition, determined on the basis of the ladle analysis, shall fulfil the requirements specified in Table 11.4. The steel shall be cast in killed condition.

**Table 11.4**  
**Chemical composition of rolled steel bars**

Grade	Chemical composition [%]					
	C max	Si	Mn	P max	S max	Al total <sup>1)</sup> min.
1	0.20	0.15÷0.35	min. 0.40	0.040	0.040	-
2 <sup>2)</sup>	0.24	0.15÷0.55	max 1.60	0.035	0.035	0.020
3 <sup>3)</sup>	Subject to PRS acceptance in each particular case					
<b>Notes:</b>						
1) Aluminium may be replaced partly or fully by other grain refining elements.						
2) Other alloying elements may be added subject to PRS acceptance in each particular case.						
3) Killed fine grain steel.						

### 11.5 Mechanical Tests

**11.5.1** Mechanical properties representing steel bars for chain cables and accessories shall fulfil the requirements specified in Table 11.5.1. The test coupons shall be in a heat treatment condition equivalent to that of the finished chain cable and accessories (see paragraph 20.3.5 of *this Part*).

**Table 11.5.1**  
**Mechanical properties of steel for chains**

Grade	Tensile test				Impact test	
	$R_e$ [MPa] min.	$R_m$ [MPa]	$A$ [%] min.	$Z$ [%] min.	Test temperature [°C]	$KV^{1)}$ [J] min.
1	-	370÷490	25	-	-	-
2	295	490÷690	22	-	0	27 <sup>2)</sup>
3	410	min. 690	17	40	0 <sup>3)</sup> -20 <sup>3)</sup>	60 35

**Notes:**

- 1) Average value from 3 test specimens. One individual value only may be below the specified average value provided it is not less than 70% of that value.
- 2) The impact test of Grade 2 may be waived, if the chain cable is supplied in heat treated condition as per Table 20.3.5 of *This Part*.
- 3) Testing shall be normally performed at 0°C.

**11.5.2** For performance of the mechanical tests, the steel bars shall be sorted according to heats and diameters – not varying by more than 4 mm – into test units not exceeding 50 tonnes each. Tensile test specimens and Charpy V-notch impact test specimens (if applicable) shall be taken from the test sample. Details of the heat treatment shall be indicated by the chain cable manufacturer.

**11.5.3** Tensile and Charpy V-notch impact test specimens shall be taken from the test sample in the longitudinal direction at a distance of  $1/6$  diameter from the surface or as close as possible to this position, as shown in Fig. 11.5.3.

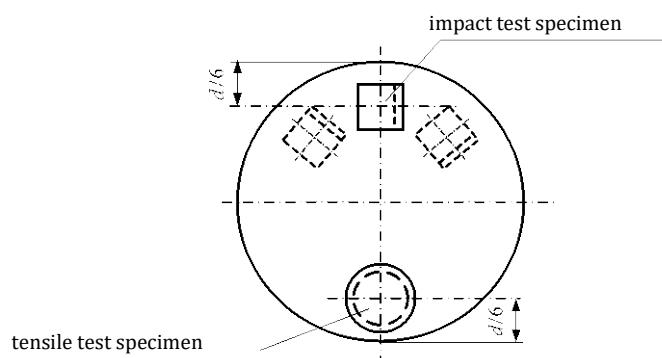

Fig. 11.5.3.

Sampling locations for tensile and impact tests

**11.5.4** Mechanical tests and retests shall be performed in accordance with the requirements specified in Chapter 2 of *this Part*.

## 11.6 Inspection of Surface and Work Quality

Unless agreed otherwise, the diameter and roundness shall be within the tolerances specified in Table 11.6. The diameter tolerances of bar stock may be positive only.



**Table 11.6**  
**Dimension tolerances of bar stock**

Nominal diameter [mm]	Diameter tolerances [mm]	Roundness tolerances ( $d_{max} - d_{min}$ ) [mm]
less than 25 mm	+1.0	0.6
25÷35	+1.2	0.8
36÷50	+1.6	1.1
51÷80	+2.0	1.5
81÷100	+2.6	1.95
101÷120	+3.0	2.25
121÷160	+4.0	3.0

### 11.7 Freedom from Defects

The materials shall be free from internal and surface defects that might impair proper workability and use.

Minor surface defects may be repaired by grinding, provided the admissible tolerances are not exceeded.

### 11.8 Marking

The minimum markings required for the steel bars are the manufacturers' brandmark, the steel grade and an abbreviated symbol of the heat.

Steel bars for chain cables shall be marked in accordance with the requirements specified in sub-chapter 1.9 of *this Part*.

### 11.9 Inspection Certificate

For bar material for Grade 2 or Grade 3, PRS issues the *Inspection Certificate* in accordance with the requirements specified in sub-chapter 1.8 of *this Part*.

## 12 STEEL FORGINGS

### 12.1 General Requirements

**12.1.1** Steel forgings which are subject to PRS survey in compliance with the requirements specified in the relevant Parts of the *Rules* shall be manufactured and tested in accordance with the following requirements.

**12.1.2** The requirements specified in this Chapter apply to steel forgings intended for hull and machinery applications where the design and acceptance tests are related to mechanical properties at the temperature of +20°C.

**12.1.3** These requirements also apply to billets, blooms and rolled bars of the diameter not exceeding 250 mm as substitutes for forgings used for the manufacture, by machining, of shafts, bolts, etc., and other components of simple shape.

**12.1.4** The requirements for forgings intended for service at low or elevated temperatures and for special steel forgings (stainless, acid-resistant, heat-resistant, etc.) are subject to PRS acceptance in each particular case.

**12.1.5** Where small and identical forgings are produced in large runs, the manufacturer may adopt alternative procedures for testing and inspection subject to PRS acceptance in each particular case.

### 12.2 Manufacturing Procedure

**12.2.1** Forgings shall be made at a manufacturer approved by PRS.

**12.2.2** Steel used in the manufacture of forgings shall be made by a process approved by PRS. The works at which the steel was produced shall be approved by PRS. Where the steel is produced at a separate works to the forging, the steel manufacturer shall be also approved by PRS.

**12.2.3** Adequate top and bottom discards shall be made to ensure freedom from piping and harmful segregations in the finished forgings.

**12.2.4** The reduction ratio of the forgings shall be such as to ensure soundness, uniformity of structure and satisfactory mechanical properties after heat treatment, and shall not be less than that specified in Table 12.2.4.

**Table 12.2.4**

Method of manufacture	Total reduction ratio
Made directly from ingots or from forged blooms, or billets	3 : 1 where $L > D$ 1.5 : 1 where $L \leq D$
Made from rolled products	4 : 1 where $L > D$ 2 : 1 where $L \leq D$

**Notes:**

1.  $L, D$  – forging length and diameter, respectively.
2. The reduction ratio shall be calculated with reference to the average cross-sectional area of the ingot. Where an ingot is initially upset, this reference area may be taken as the average cross-sectional area after this operation.
3. For rolled bars used as substitutes for forgings, the reduction ratio shall be at least 6 : 1.
4. For forgings made by upsetting, the length after upsetting shall not be more than one-third of the length before upsetting or – in the case of an initial forging reduction of at least 1.5 : 1 – no more than one-half of the length before upsetting.

Where disc type forgings (e.g. gear wheels) are made by upsetting, the thickness of any part of the disc shall not be greater than one half of the length of the billet from which it was formed, provided this billet has received an initial forging reduction of not less than 1.5:1.

Where the piece used has been cut directly from an ingot or where the billet has received an initial reduction of less than 1.5:1, the thickness of any part of the disc shall not be greater than one third of the length of the original piece.

Rings and other types of hollow forgings shall be made from pieces cut from ingots or billets and which have been suitably punched. Alternatively, pieces from hollow cast ingots may be used. The wall thickness of the forging shall not be greater than one half of the thickness of the prepared hollow piece from which it was formed. In other cases, the forging procedure shall be such as to ensure that adequate work is given to the piece prior to punching. This may be either longitudinal or upset working of not less than 2:1 of the reduction ratio.

**12.2.5** For certain components, where grain flow is required in the most favourable direction having regard to the mode of stressing in service, the proposed method of manufacture shall be approved by PRS and tests may be required to demonstrate that a satisfactory structure and grain flow are obtained.

**12.2.6** Unless agreed otherwise, shaping of forgings or rolled slabs and billets by flame cutting, scarfing or arc-air gouging shall be performed before the final heat treatment. Pre-heating may be required by PRS when necessitated by the chemical composition and thickness of the forging.

**12.2.7** Where two or more forgings are joined by welding to form a composite component, details of the proposed procedure are subject to PRS acceptance in each particular case. In that case, PRS may require that appropriate weldability tests should be performed.

**12.2.8** Publication No. 74/P *Principles for Welding Procedure Qualification Tests* is applicable to the requirements for welding procedure qualification tests of steel forgings intended to be used for the components of hull construction and marine structures.

**12.2.9** Welders intended to be engaged in fusion welding of steel forgings for hull structures are to be qualified in accordance with the Publication No. 30/P *Principles of Examination of Welders*.

### **12.3 Quality of Forgings**

Each forging shall be free from surface or internal defects which would be prejudicial to their proper application in service.

### **12.4 Chemical Composition**

**12.4.1** Forgings shall be made from killed steel and the chemical composition shall be appropriate for the type of steel, dimensions and required mechanical properties of the forgings being manufactured.

**12.4.2** Chemical composition of each heat shall be determined by the manufacturer on a sample taken preferably during the pouring of the heat. When multiple heats are tapped into a common ladle, the ladle analysis shall apply.

**12.4.3** Chemical composition determined by ladle analysis shall comply with the overall limits specified in Table 12.4.3-1 and Table 12.4.3-2. At the option of the manufacturer, suitable grain refining elements such as aluminium, niobium or vanadium may be added. The content of each of such elements shall be included in the Inspection Certificate.

**12.4.4** Elements designated as residual elements in the individual specifications shall not be intentionally added to steel. The content of such elements shall be included in the *Inspection Certificate*.

**Table 12.4.3-1**  
**Chemical composition limits <sup>1)</sup> for hull steel forgings <sup>6)</sup>**

Steel type	Chemical composition [%]									
	C max.	Si max.	Mn	P max.	S max.	Cr <sup>4)</sup> max.	Mo <sup>4)</sup> max.	Ni <sup>4)</sup> max.	Cu <sup>4)</sup> max.	Total residuals max.
Unalloyed	0.23 <sup>2),3)</sup>	0.45	0.30÷1.50	0.035	0.035	0.30 <sup>4)</sup>	0.15 <sup>4)</sup>	0.40 <sup>4)</sup>	0.30	0.85
Alloy	<sup>5)</sup>	0.45	<sup>5)</sup>	0.035	0.035	<sup>5)</sup>	<sup>5)</sup>	<sup>5)</sup>	0.30	–

<sup>1)</sup> Composition in percentage mass by mass maximum unless shown as a range.  
<sup>2)</sup> Carbon content may be increased above this level provided that the carbon equivalent CEV is not more than 0.41% calculated in accordance with the following formula:

$$CEV = C + \frac{Mn}{6} + \frac{Cr + Mo + V}{5} + \frac{Ni + Cu}{15} \quad [%]$$

<sup>3)</sup> Carbon content for unalloyed steel forgings not intended for welded construction may be 0.65% maximum.  
<sup>4)</sup> Elements are considered as residual elements.  
<sup>5)</sup> Specification is subject to PRS acceptance in each particular case.  
<sup>6)</sup> Rudder stocks and pintles shall be of weldable quality.

**Table 12.4.3-2**  
**Chemical composition limits <sup>1)</sup> for machinery steel forgings**

Steel type	Chemical composition [%]									
	C max.	Si max.	Mn	P max.	S max.	Cr <sup>4)</sup>	Mo <sup>4)</sup>	Ni <sup>4)</sup>	Cu <sup>4),3)</sup> max.	Total residuals max.
Unalloyed	0.23 <sup>2),3)</sup> <del>0.65<sup>2)</sup></del>	0.45	0.30÷1.50	0.035	0.035	max. 0.30 <sup>3)</sup>	max. 0.15 <sup>3)</sup>	max. 0.40 <sup>3)</sup>	0.30	0.85
Alloy <sup>5),4)</sup>	0.45	0.45	0.30÷1.00	0.035	0.035	min 0.40 <sup>6),5)</sup>	min 0.15 <sup>6),5)</sup>	min 0.40 <sup>6),5)</sup>	0.30	–

<sup>1)</sup> Composition in percentage mass by mass maximum unless shown as a range.  
<sup>2)</sup> Carbon content may be increased above this level, provided that the carbon equivalent CEV is not more than 0.41%.  
<sup>3)</sup> The carbon content of C and C-Mn steel forgings not intended for welded construction may be 0.65 maximum.  
<sup>4),3)</sup> Elements are considered as residual elements unless shown as a minimum.  
<sup>5),4)</sup> Where alloy steel forgings are intended for welded constructions, the proposed chemical composition is subject to PRS acceptance in each particular case.  
<sup>6),5)</sup> One or more of the elements shall fulfil the minimum content requirement.

## 12.5 Supply Condition

**12.5.1** Forgings shall be suitably heat treated to refine the grain structure and to obtain the required mechanical properties. The heat treatment may be as follows:

- a) for carbon and carbon-manganese steels
  - full annealing,
  - normalising,
  - normalising and tempering,
  - quenching and tempering;
- b) for alloy steels
  - normalising,
  - normalising and tempering,
  - quenching and tempering.

For all types of steel the tempering temperature shall not be less than 550°C. Where forgings for gearing are not intended for surface hardening, lower tempering temperature may be allowed.

The delivery condition shall meet the design and application requirements, it is the manufacturer's responsibility to select the appropriate heat treatment method to obtain the required mechanical properties. Where forgings for gearing are not intended for surface hardening, lower tempering temperature may be allowed.

**12.5.2** Heat treatment shall be performed in properly constructed furnaces which have adequate means for control and recording of temperature. The furnace dimensions shall be such as to allow the whole furnace charge to be uniformly heated to the necessary temperature. In the case of very large forgings, alternative methods of heat treatment are subject to PRS acceptance in each particular case.

**12.5.3** Heat treatment conditions shall be determined by the manufacturer having regard to chemical composition of steel, purpose and size of the forging, taking into account the following conditions:

- adequate number of thermocouples shall be included in the furnace charge for measurement and recording of the temperature distribution and its evenness,
- if a forging is subsequently heated for further hot working, it shall be re-heat treated,
- where forgings shall be surface hardened, the details of the procedure shall be agreed with PRS. In that case, PRS may require to demonstrate by test that the proposed procedure ensures a uniform surface layer of the required hardness and depth,
- where induction hardening, nitriding or carburizing will be performed after machining, forgings shall be heat treated at an appropriate stage (e.g. in the case of carburized products – full annealing or normalizing and tempering) to a condition suitable for subsequent machining and hardening,
- if any straightening operation is performed after the final heat treatment, consideration shall be given to a subsequent stress relieving heat treatment to avoid the possibility of harmful residual stresses. The manufacturer shall have strict control of this temperature in order to avoid any detrimental effects to the final heat treatment and residual microstructure and mechanical properties of the forging,
- forging shop shall maintain records of heat treatment containing the data about the furnaces used, date, temperature and hold time; the records shall be presented to the PRS surveyor on request.

## 12.6 Mechanical Tests

**12.6.1** Forgings shall be submitted for acceptance individually or as a batch.

**12.6.2** Where a number of small forgings of about the same size and mass are made from one cast and are heat treated in the same furnace charge, batch testing procedures may be adopted using one of the forgings for the test purposes or alternatively using separately forged test samples. These test samples shall have a reduction ratio similar to that used for the forgings which they represent. They shall be properly identified and heat treated along with the forgings. In such cases, at least one set of specimens shall be taken from each batch.

**12.6.3** The size of a test sample shall be sufficient for the required tests and for possible re-tests. The cross-section of the test sample shall not be less than that of the forging which it represents. Except for special cases, the test samples shall be integral with forgings. Separately forged test material shall have a reduction ratio similar to that used for the forgings represented.

**12.6.4** The set of test specimens shall consist of one tensile and, subject to PRS acceptance in each particular case, three impact test specimens. Impact tests shall be performed where:

- it is stated in the order specifications,
- forging is intended for the propeller shaft with ice class notation (see Note 2 to Table 12.7.1-2 in *this Part*).

**12.6.5** Test specimens shall be cut with their axes either mainly parallel or mainly tangential to the principal axial direction of each product. As far as possible, the specimens shall be so located that the distance from the surface of the forging to the nearest surface of the specimen be not less than 10 per cent of the diameter or thickness of the forging.

**12.6.6** The test specimens shall be positioned as follows:

- .1 for forgings having a thickness  $t$  or diameter  $D$  up to 50 mm, the longitudinal axis of the test specimens is to be located at a distance of  $t/2$  or  $D/2$  below the heat treated surfaces,
- .2 for forgings having a thickness  $t$  or diameter  $D$  greater than 50 mm, the longitudinal axis of the test specimen is to be located at a distance of  $t/4$  or  $D/4$  (mid-radius) or 80 mm, whichever is less, below any heat treated surface. Test specimen is to be located with its longitudinal axis at a distance from any heat treated surface as shown in Fig. 12.6.6,
- .3 for ring and disc forgings (noting that the test specimen locations for these shaped forgings may be different to elongated or free form forgings), tangential sample shall be taken at  $t/2$  for thickness  $t \leq 25$  mm and 12.5 mm below the surface for thickness  $t > 25$  mm, in both the vertical and horizontal direction. Where achievable, for thickness  $t > 25$  mm, no part of the test material shall be closer than 12.5 mm to any heat treated surface, as shown in Fig. 12.6.6.

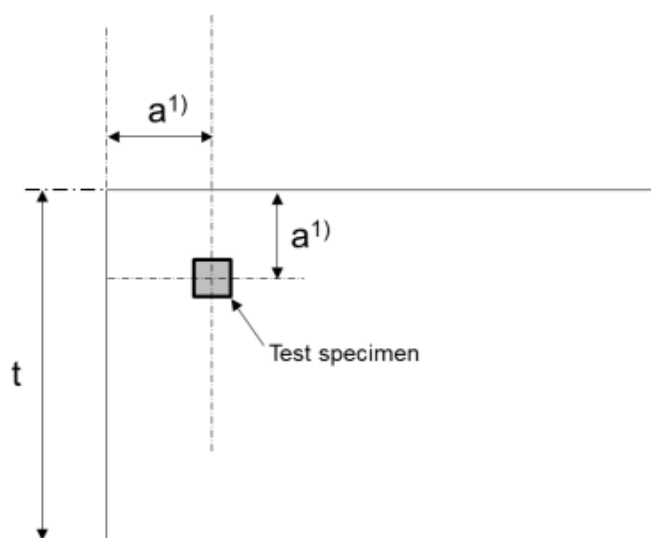

<sup>1)</sup>  $a$  is the distance from the test specimen to heat treated surface based on the above .2 or .3

Fig. 12.6.6

Where the manufacturer can demonstrate that a proposed testing location or orientation is more representative of the required mechanical properties of a component, this may be agreed by PRS. In such cases, the heat treatment process, a proposed testing location or orientation, and technical justification shall be submitted to PRS for approval.

**12.6.7** In sub-paragraphs .1 to .8 below, the examples of typical forgings, as well as the number and position of the specimens for acceptance tests, are given; these requirements do not apply to the forgings described in paragraph 12.6.12.

For the purpose of the present Chapter, transverse specimens, tangential specimens and radial specimens are considered as transverse specimens.

**.1 Forgings for shafts, rudderstocks, pins and connecting-rods, etc., of longitudinal shape**

From each forging, one set of specimens shall be taken in a longitudinal direction, as shown in Figures 12.6.7.1-1, 12.6.7.1-2 or 12.6.7.1-3 in A position. Subject to PRS Surveyor's consent, a set of specimens may be taken in a transverse direction, according to positions B, C or D, except for the specimens taken as shown in Fig 12.6.7.1-2, position B, which shall be considered longitudinal.

**Note:** Where the mass of the forging exceeds 4 tonnes and the length exceeds 3000 mm, one set of specimens shall be taken from each end (the mass and the length of the forging in the as forged condition, excluding the test material).

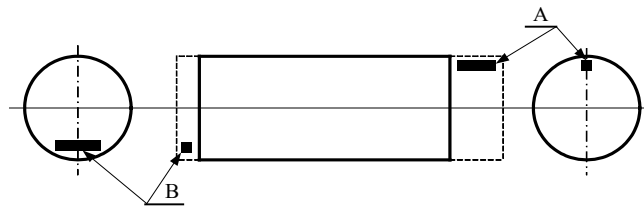

Fig. 12.6.7.1-1

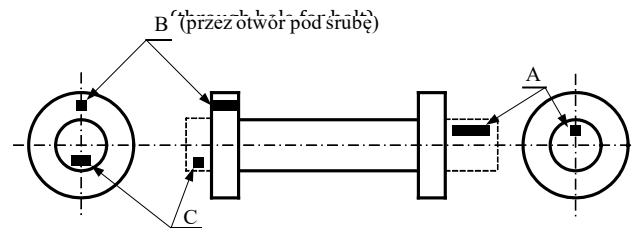

Fig. 12.6.7.1-2

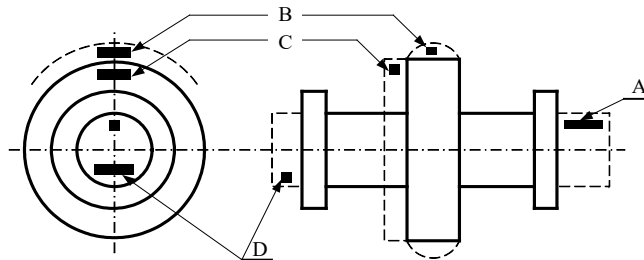

Fig. 12.6.7.1-3

**.2 Pinions**

Where the finished machined diameter of the toothed portion exceeds 200 mm, one set of specimens shall be taken from each forging in a transverse direction adjacent to the toothed portion, in accordance with Fig. 12.6.7.2, test position B or test position C when the dimensions of the forging do not permit the preparation of test from position B. From the pinions of a diameter not exceeding 200 mm, one set of specimens shall be taken in a longitudinal direction, as shown in Fig. 12.6.7.2 – position A.

Where the finished length of the toothed portion exceeds 1250 mm, one set of specimens shall be taken from each end.

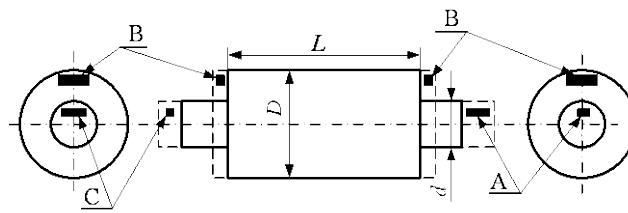

Fig. 12.6.7.2

**.3 Gear wheels**

One set of specimens shall be taken from each forging in a transverse direction, as shown in Fig.12.6.7.3 – position A or B.

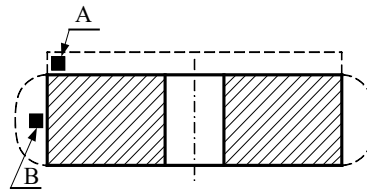

Fig. 12.6.7.3

**.4 Gear wheel rims (made by expanding)**

One set of specimens shall be taken in a longitudinal direction from each forging, as shown in Fig. 12.6.7.4 – position A. Where the finished diameter exceeds 2500 mm or the mass of the forging exceeds 3 tonnes (“as heat treated forged”, including test material), two set of specimens shall be taken from diametrically opposite positions, as shown in Fig.12.6.7.4 – position A and B.

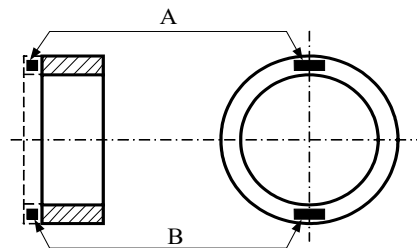

Fig. 12.6.7.4

**.5 Pinion sleeves**

One set of specimens shall be taken from each forging in a transverse direction, as shown in Fig. 12.6.7.5 – position A or B. Where the finished length exceeds 1250 mm, one set of specimens shall be taken from each end.

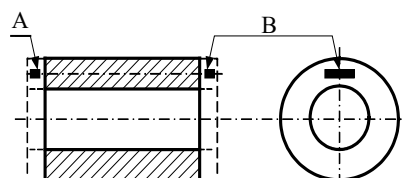

Fig. 12.6.7.5

**.6 Crankwebs**

One set of specimens shall be taken from each forging in a transverse direction (the test position is subject to PRS acceptance in each particular case).



**.7 Solid forged crankshafts**

One set of specimens shall be taken in a longitudinal direction from the coupling end, as shown in Fig. 12.6.7.7 – position A. Where the mass of the forging exceeds 3 tonnes (“as forged”, excluding test material), specimens in a longitudinal direction shall be taken from each end (positions A and B).

Where the crankthrows are formed by machining or flame cutting, the second set of specimens shall be taken in a transverse direction from the material removed from the crankthrow (position C).

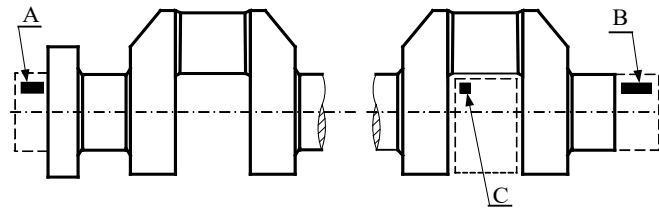
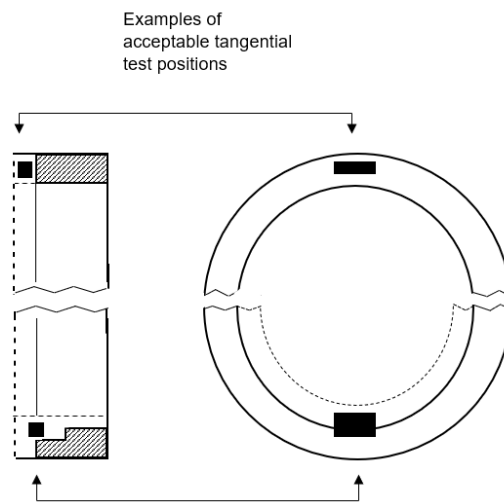

Fig. 12.6.7.7

**.8 Forged rings (such as slewing rings)**

One set of specimens shall be taken from each forging in a tangential direction, as shown in Fig. 12.6.7.8. Where the finished diameter exceeds 2.5 m or the mass (as heat treated, including test material) of the forging exceeds 3 tonnes, two sets of specimens shall be taken



from diametrically opposite positions.

Fig. 12.6.7.8

**.9 Combined web and pin crankshaft forgings and other forgings**

The number and position of specimens are subject to PRS acceptance in each particular case.

**12.6.8** For die forgings and crankshaft forgings where the method of manufacture has been specially approved in accordance with the requirements specified in paragraph 12.2.7, the number and position of test specimens shall be agreed with PRS, having regard to the method of manufacture employed.

**12.6.9** Where a forging is subsequently divided into a number of components, all of which are heat treated together in the same furnace charge, for the test purposes this may be regarded as one forging and the number of tests required shall be related to the total length and mass of the original multiple forging.

**12.6.10** Except for components which will be carburised or other components agreed with PRS, the test material shall not be cut from a forging until all heat treatment has been complete.

**12.6.11** Unless otherwise agreed with PRS, where forgings are intended to be carburised, sufficient material shall be provided (at locations specified in paragraph 12.6.7) for both preliminary tests at the forge and for final tests after completion of carburising. In that case, irrespective of the dimensions and mass of the forging, test specimens are required from one position only.

This test material shall be machined to a diameter of  $D/4$  or 60 mm, whichever is less, where  $D$  is the finished diameter of the toothed portion.

At the orderer's request, for preliminary tests at the forge, one set of test material shall be given a blank carburizing and heat treatment cycle simulating that which subsequently will be applied to the forging.

For final acceptance tests, the second set of test material shall be blank carburized and heat treated along with the forgings which they represent.

At the discretion of the forgemaster or gear manufacturer test samples of larger cross section may be either carburized or blank carburized, but these shall be machined to the required diameter prior to the final quenching and tempering heat treatment.

Alternative procedures for testing of forgings which will be carburized and position of test specimens in the forgings not mentioned in paragraphs from 12.6.7.1 to 12.6.7.8 are subject to PRS acceptance in each particular case.

**12.6.12** Normalized forgings with mass up to 1000 kg each and quenched and tempered forgings with mass up to 500 kg each may be batch tested. A batch shall consist of forgings of similar shape and dimensions, made from the same heat of steel, heat treated in the same furnace charge and with a total mass not exceeding 6 tonnes for normalized forgings and 3 tonnes for quenched and tempered forgings, respectively.

**12.6.13** A batch testing procedure may also be applied for hot rolled bars with a diameter not exceeding 250 mm used instead of forgings.

A batch consists of:

- material from the same rolled ingot or bloom, provided that where this is cut into individual lengths, these are all heat treated in the same furnace charge, or
- bars of the same diameter and heat, heat treated in the same furnace charge and with a total mass not exceeding 2.5 tonnes.

**12.6.14** Preparation of test specimens and the procedures used for mechanical testing shall fulfil the relevant requirements specified in Chapter 2 of *this Part*. Unless otherwise agreed, all tests shall be performed in the presence of PRS Surveyor.

## 12.7 Mechanical Properties

**12.7.1** The minimum requirements for yield stress, elongation, reduction of area and impact energy values of alloy steel and unalloyed steel forgings are specified in Table 12.7.1-1 and Table 12.7.1-2. Where a steel with a specified minimum tensile strength intermediate to those given is intended to be used, the corresponding minimum values for other properties may be obtained by interpolation. Mechanical properties shall fulfil the requirements specified in Table 12.7.1-1 and Table 12.7.1-2 appropriate to the specified minimum tensile strength or, where applicable, the requirements of the approved specification.

**Table 12.7.1-1**  
**Mechanical properties of hull steel forgings**

Steel grade	$R_m$ min <sup>1)</sup> [MPa]	$R_e$ min [MPa]	A min [%]		Z min [%]		KV min [J] at 0°C <sup>2)</sup>	
			L	T	L	T	L	T
Unalloyed	400	200	26	19	50	35	27	18
	440	220	24	18	50	35		
	480	240	22	16	45	30		
	520	260	21	15	45	30		
	560	280	20	14	40	27		
	600	300	18	13	40	27		
Alloy	550	350	20	14	50	35		
	600	400	18	13	50	35		
	650	450	17	12	50	35		

<sup>1)</sup> The following ranges for tensile strength may be additionally specified:  
specified minimum tensile strength: < 600 MPa ≥ 600 MPa  
tensile strength range: 120 MPa 150 MPa

<sup>2)</sup> Special consideration may be given to alternative requirements for Charpy V-notch test, depending on design and application, and subject to agreement by PRS.

**Table 12.7.1-2**  
**Mechanical properties of machinery steel forgings <sup>2)</sup>**

Steel grade	$R_m$ min <sup>1)</sup> [MPa]	$R_e$ min [MPa]	A min [%]		Z min [%]		Hardness <sup>3)</sup> (Brinell)	KV min. [J] <sup>2)4)</sup>		
			L	T	L	T		Test temp.	L	T
Unalloyed	400	200	26	19	50	35	110-150	AT <sup>5)</sup>	27	18
	440	220	24	18	50	35	125-160			
	480	240	22	16	45	30	135-175			
	520	260	21	15	45	30	150-185			
	560	280	20	14	40	27	160-200			
	600	300	18	13	40	27	175-215			
	640	320	17	12	40	27	185-230			
	680	340	16	12	35	24	200-240			
	720	360	15	11	35	24	210-250			
Alloy	600	360	18	14	50	35	175-215			
	700	420	16	12	45	30	205-245			
	800	480	14	10	40	27	235-275			
	900	630	13	9	40	27	260-320			
	1000	700	12	8	35	24	290-365			
	1100	770	11	7	35	24	320-385			

<sup>1)</sup> The following ranges for tensile strength values may be additionally specified:  
specified minimum tensile strength: < 900 MPa ≥ 900 MPa  
tensile strength range: 150 MPa 200 MPa.

<sup>2)</sup> For materials used for machinery exposed to sea water temperature, such as propeller shafts and shaft bolts, intended for ships with ice class notation IA Super, IA, IB, IC, Charpy V-notch impact testing shall be performed for all steel types at -10°C, and the average energy value shall be minimum 27 J (longitudinal test). One individual value may be less than the required average value provided that it is not less than 70% of this average value.

<sup>3)</sup> The hardness values are typical and are given for information purposes only.

<sup>4)</sup> Special consideration may be given to alternative requirements for Charpy V-notch test, depending on design and application, and subject to agreement by PRS.

<sup>5)</sup> AT refers to Ambient Temperature (i.e. +23°C±5°C), which is specified in ISO 148-1:2016.

- 12.7.2** PRS requires that hardness tests be performed for forgings in accordance with the following:
- for gear forgings: after completion of heat treatment and prior to gear teeth machining, hardness shall be determined at four positions equally spaced around the circumference of the surface where the teeth will be subsequently cut; where the finished diameter of the toothed portion exceeds 2500 mm, the above number of test positions shall be increased to eight; where the width of a gear wheel rim forging exceeds 1250 mm, hardness shall be determined at eight positions at each end of the forging;
  - for small crankshaft and gear forgings which have been batch-tested, at least one hardness test shall be performed on each forging;
  - for forgings which have been induction hardened, nitrided or carburised: the results of hardness tests shall fulfil the requirements of the approved specifications.

**12.7.3** Where the tensile test results fail to fulfil the requirements of the Rules, re-tests shall be performed in accordance with the requirements specified in sub-chapter 2.3 of this Part.

**12.7.4** The additional tests mentioned in paragraph 12.7.3 shall be performed on specimens taken, preferably, from the material adjacent to the original specimens, but from another test position or sample representative of the forging or batch of forgings.

**12.7.5** At the option of the manufacturer, where a forging or a batch of forgings has failed to meet the test requirements of the Rules, it may be reheat treated and re-submitted for acceptance tests.

## **12.8 Inspection of Surface and Work Quality**

**12.8.1** All forgings shall be subjected to a 100% visual examination to all accessible surfaces by the manufacturer and made available to PRS Surveyor. Where applicable, this visual examination shall include the examination of internal surfaces and bores. Unless otherwise agreed, the verification of dimensions is the responsibility of the manufacturer.

**12.8.2** Where required by the *Rules* or by an approved procedure for welded composite components (see paragraph 12.2.7), appropriate non-destructive testing shall also be performed before acceptance and the results shall be reported by the manufacturer.

**12.8.3** Where required by appropriate *Rules*, ultrasonic examination shall be carried out after the forgings have been machined to a condition suitable for this type of examination and after the final heat treatment. Both radial and axial scanning are to be carried out where appropriate for the shape and the dimensions of the forgings being examined.

**12.8.4** The method and the extend of inspection, non-destructive testing and acceptance criteria shall be agreed with PRS. *Publication No. 70/P* is regarded as an example of acceptable standard. For mass produced forgings the extent of examination shall be established at the PRS discretion.

**12.8.5** Unless otherwise agreed, examinations shall be carried out by the manufacturer, although PRS Surveyor may request to be present in order to verify that the examination is being carried out in accordance with the agreed procedure.

**12.8.6** If the forging is supplied in the “as forged” condition for machining at a separate works, the manufacturer shall ensure that a suitable ultrasonic examination is carried out to verify the internal quality of the forging.

**12.8.7** Where advanced ultrasonic testing methods are applied, e.g. PAUT or TOFD, reference is made to *Publication No. 80/P* for general approach in adopting and application of these advanced methods. In such cases, acceptance levels regarding accept/reject criteria may be as per the applicable section of *Publication No. 70/P*.

**12.8.8** When required by the conditions of approval for surface hardened forgings, additional test samples shall be processed at the same time as the forgings which they represent. These test samples shall be subsequently sectioned in order to determine the hardness, shape and depth of the locally hardened zone which shall fulfil the requirements of the approved specification.

**12.8.9** In the event of any forging proving defective during subsequent machining or testing, it shall be rejected notwithstanding any previous certification.

## **12.9 Rectification of Defective Forgings**

**12.9.1** Surface imperfections may be accepted, provided they are within the limits of machining allowance. Slight surface imperfections found during visual inspections or non-destructive tests may be removed by grinding or by chipping and grinding. Complete elimination of the defective material shall be verified by magnetic particle testing or liquid penetrant testing.

**12.9.2** Repair welding of forgings except those subjected to torsional fatigue, such as crankshaft forgings, may be permitted subject to prior approval by PRS. In such cases, full details of the extent and location of the repair the proposed welding procedure, heat treatment and subsequent inspection procedures shall be submitted to PRS for approval. The areas to be repaired and the testing results shall be indicated in a drawing or sketch of the forging.

**12.9.3** Defects may be removed provided the component dimensions are acceptable. The resulting grooves shall have a bottom radius of approximately three times the groove depth and shall be blended into the surrounding surface so as to avoid any sharp contours.

**12.9.4** The forging manufacturer shall maintain records of repairs and subsequent inspections traceable to each forging repaired. The records shall be presented to PRS Surveyor on request.

## **12.10 Identification of Forgings**

The manufacturer shall adopt a system of identification which will enable all finished forgings to be traced to the original cast and the Surveyor shall be given full facilities for so tracing the forgings when required.

Where small forgings are manufactured in large numbers, modified arrangements for identification are subject to PRS acceptance in each particular case.

## **12.11 Marking**

Marking of steel forgings shall fulfil the requirements specified in sub-chapter 1.9 of *this Part*. The following particulars may be required by PRS:

- .1 category or grade of steel,
- .2 number of cast, number of batch or other marking which will enable the full history of the forging to be traced,
- .3 manufacturer's name or brand,
- .4 test pressure, where applicable,
- .5 date of final inspection,
- .6 PRS *Inspection Certificate* number,
- .7 PRS stamp.

## **12.12 Inspection Certificate**

For steel forgings, PRS issues an *Inspection Certificate* in accordance with the requirements specified in sub-chapter 1.8 of *this Part*. In addition to the particulars specified in sub-chapter 1.8 of *this Part*, the following information shall be included in the *Inspection Certificate*:

- .1 results of non-destructive tests, where applicable,
- .2 details of heat treatment, including temperature and holding times.

## 13 STEEL CASTINGS

### 13.1 Carbon Steel Castings for Hull and Machinery Components

#### 13.1.1 General Requirements

**13.1.1.1** Steel castings of essential parts which are subject to PRS survey in accordance with the provisions of the relevant Parts of the Rules, shall be manufactured and tested in accordance with the requirements specified below.

**13.1.1.2** The requirements specified in this Chapter apply to carbon, carbon-manganese and alloy steel castings intended for the hull and machinery components, intended for fabrication by welding, as well as grades not intended for welding.

**13.1.1.3** Additional requirements may be necessary for castings intended for service at low or elevated temperatures a e.g. for ships with ice-class notation or for boilers. Additional requirements will typically be required for castings for offshore units depending on applicable service temperature and environment.

**13.1.1.4** Similarly, C and C-Mn steel casting and alloy steel castings which comply with national or proprietary specifications may be accepted provided such specifications give reasonable equivalence to these requirements or are otherwise specially approved or required by PRS.

#### 13.1.2 Manufacture

**13.1.2.1** Castings shall be made at manufacturers approved by PRS and using processes approved by PRS.

**13.1.2.2** All flame cutting, scarfing or arc-air gouging to remove surplus metal shall be undertaken in accordance with recognized good practice and shall be performed before the final heat treatment. Preheating shall be employed when necessitated by the chemical composition and/or thickness of the castings. If necessary, the affected areas shall be either machined or ground smooth.

**13.1.2.3** For essential components including steel castings subjected to surface hardening process, the proposed method of manufacture requires PRS acceptance in each particular case.

**13.1.2.4** When joining two or more castings by welding to form a composite component, the welding procedure shall be approved in accordance with *Publication No. 74/P* and the welders shall be qualified in accordance with *Publication No. 30/I*.

#### 13.1.3 Quality of Castings

Each casting shall be free from surface or internal defects which would be prejudicial to their proper application in service. The surface finish shall be in accordance with good practice and any specific requirements of the approved plan.

#### 13.1.4 Chemical Composition

**13.1.4.1** Steel castings shall be made from killed steel and the chemical composition shall be appropriate for the type of steel, dimensions and mechanical properties specified for the castings.

**13.1.4.2** Chemical composition of each heat shall be determined by the manufacturer on a sample taken preferably during the pouring of the heat. When multiple heats are tapped into a common ladle, the ladle analysis shall apply.

**13.1.4.3** The chemical composition shall fulfil the requirements for the overall limits specified in Table 13.1.4.3-1 and 13.1.4.3-2, respectively, or, where applicable, the requirements of the approved specification.

**Table 13.1.4.3-1**  
**Chemical composition limits for hull and machinery steel castings [%]**  
**(carbon and carbon-manganese steels)**

Steel type	Applications	C max.	Si max.	Mn	S max.	P max.	Residual elements, max.				Total residuals max.
							Cu	Cr	Ni	Mo	
C, C-Mn steel	Castings for non-welded construction	0.40	0.60	0.50÷1.60	0.035 <del>0.04</del>	0.035 <del>0.04</del>	0.30	0.30	0.40	0.15	0.80
	Castings for welded construction	0.23	0.60	0.50÷1.60 max.	0.035 <del>0.04</del>	0.035 <del>0.04</del>	0.30	0.30	0.40	0.15	0.80

**Table 13.1.4.3-2**  
**Chemical composition limits for hull and machinery steel castings [%]**  
**(alloy steels)**

Steel type	Applications	C max.	Si max.	Mn	S max.	P max.	Alloying elements <sup>1)</sup> , min.			
							Cu	Cr	Ni	Mo
C, C-Mn steel	Castings for non-welded construction	0.45	0.60	0.50÷1.60	0.030	0.035	0.30	0.40	0.40	0.15
	Castings for welded construction	alloying elements values are subject to agreement with PRS								

1) At least one of the elements shall comply with the minimum content

**13.1.4.4** Suitable grain refining elements may be used at the discretion of the manufacturer or as agreed with PRS.

### 13.1.5 Supply Condition

**13.1.5.1** Steel castings shall be properly heat treated to refine the grain structure and to obtain the required mechanical properties. Castings shall be supplied in one of the following delivery conditions:

- a) for carbon and carbon-manganese steels
  - full annealing,
  - normalising,
  - normalising and tempering,
  - quenching and tempering;
- b) for alloy steels
  - normalising,
  - normalising and tempering,
  - quenching and tempering.

For all types of steel the tempering temperature shall not be less than 550°C.

The delivery condition shall meet the design and application requirements. It is manufacturer's responsibility to select the appropriate heat treatment method to obtain the required mechanical properties.

**13.1.5.2** Castings for such components as crankshafts, engine bed plates, etc., where dimensional stability and freedom from internal stresses are important shall be given stress relief heat treatment. This shall be performed at a temperature of not less than 550°C followed by furnace cooling to 300°C or lower.

**13.1.5.3** Heat treatment shall be performed in properly constructed furnaces which are efficiently maintained and have adequate means for control and recording of temperature. The furnace dimensions shall be such as to allow the whole casting to be uniformly heated to the necessary temperature. In the case of very large castings, alternative methods for heat treatment are subject to PRS acceptance in each particular case. Sufficient number of thermocouples shall be connected to the furnace charge to measure and record that its temperature is adequately uniform.

**13.1.5.4** If a casting is locally reheated or any straightening operation is performed after the final heat treatment, PRS may require subsequent stress relieving heat treatment in order to avoid the possibility of harmful residual stresses. The manufacturer shall have strict control of the temperature in order to avoid any detrimental effects to the final heat treatment and resultant microstructure and mechanical properties of the casting.

**13.1.5.5** The foundry shall maintain records of heat treatment identifying the furnace used, furnace charge, date, temperature and time at temperature. The records shall be presented to PRS Surveyor on request.

### **13.1.6 Mechanical Tests**

**13.1.6.1** Test material, sufficient for the required tests and for possible retest purposes shall be provided for each casting or batch of castings.

**13.1.6.2** Where castings of similar size and form are made from one cast and heat-treated in the same furnace charge, a batch testing procedure may be adopted using separately cast test samples of suitable dimensions or the test samples shall be taken directly from a casting of the same batch.

**13.1.6.3** At least one test block shall be provided for each casting **or batch of castings**. These test blocks shall be either **attached to the castings, cast integrally on the castings or cast separately**.

**13.1.6.4** **The preferred test block arrangement, where practical, is for the manufacturer to provide at least one 30 mm test block by either attached to the castings or cast integrally on the castings (see note 1).**

**Note 1:** The test results represent the material from which the castings have been poured and the subsequent heat treatment process and may not necessarily represent the properties of the castings. These properties can be affected by solidification conditions and the rate of cooling during heat treatment, which are in turn influenced by casting thickness, size, complexity and shape. The purpose of the test block is to provide a qualitative check to demonstrate the effective control of existing heat treatment processes and procedures.

**For castings where it is required that the mechanical properties need to be demonstrated for specific section thicknesses and when agreed upon between the manufacturer and the purchaser, then proposals (see note 2) for alternative test block arrangements (in terms of size and type) shall be submitted for approval by PRS.**

**Note 2:** The size of the test blocks for mechanical testing may be determined by the ruling section of the casting that they are representative of the casting's heat treatment and microstructure. Also see ISO 4885,2018; ISO683-1:2016 and ISO 683-2: 2016.

Alternatively, determination of test block size and type may be supported by historical and statistical test data, production of a representative test block or a component, simulation software, or a combination of all these items.

**13.1.6.5** Where the casting is of complex design or where the finished mass exceeds 10 tonnes, at least two cast on test blocks shall be taken, located as far as practicable from each other. Where castings are made from two or more casts, which are not mixed in a ladle prior to pouring, two or more of test blocks shall be provided corresponding to the number of casts involved. These shall be **attached to the casting or cast integrally on the castings** at locations as widely separated as possible.



**13.1.6.6** For castings to which the requirements specified in paragraph 13.1.2.3 are applicable, the number and position of tests blocks shall be agreed with PRS having regard to the method of manufacture employed.

**13.1.6.7** Where a number of small castings of about the same size, each of which is under 1000 kg in mass, are made from one cast and heat treated in the same furnace charge, a batch testing procedure may be adopted using separately cast test blocks of suitable dimensions as specified in paragraph 13.1.6.3. At least one test block shall be provided for each batch of castings.

**13.1.6.8** Test blocks shall not be detached from the casting until the specified heat treatment has been complete and they have been properly identified.

**13.1.6.9** At least one tensile test specimen and one set of impact test specimens shall be taken from each test block.

**13.1.6.10** Preparation of test specimens and the procedures used for mechanical testing shall fulfil the relevant requirements specified in Chapter 2 of *this Part*. Unless otherwise agreed, all tests shall be performed in the presence of PRS Surveyor.

### 13.1.7 Mechanical Properties

**13.1.7.1** Depending on the minimum requirements for tensile strength, the yield stress, elongation, reduction of area and impact test energy values of ~~carbon~~ steel castings shall fulfil the requirements specified in Tables 13.1.7.1-1 and 13.1.7.1-2. Where it is proposed to use steel with a specified minimum tensile strength intermediate to those indicated, the corresponding minimum values for other properties may be obtained by interpolation.

**Table 13.1.7.1-1  
Mechanical properties for steel castings  
intended for welding (minimum limits)**

Steel grade	$R_m$ <sup>1)</sup> [MPa]	$R_e$ [MPa]	A [%]	Z [%]	Charpy V-notch impact test <sup>2)</sup>	
					Test temp. [°C]	KV [J]
200-400	400	200	25	40	0	27
220-440	440	220	22	30		
240-480	480	240	20	27		
260-520	520	260	18	25		
280-560	560	280	15	20		
300-600	600	300	13	20		
Alloy	550	355	18	30	0	27
	600	400	16	30		
	650	450	14	30		
	700	540	12	28		

1) PRS may require that a minimum value of tensile strength not be exceeded by more than 150 MPa.  
2) Special consideration may be given to alternative requirements for Charpy V-notch impact test, depending on design and application and subject to agreement with PRS.

**Table 13.1.7.1-2**  
**Mechanical properties for machinery steel castings**  
**not intended for welding (minimum limits)**

Steel grade	$R_m$ <sup>1)</sup> [MPa]	$R_e$ [MPa]	A [%]	Z [%]	Charpy V-notch impact test <sup>2)</sup>	
					Test temp. [°C]	KV [J]
200-400	400	200	25	40	0	27
220-440	440	220	22	30		
240-480	480	240	20	27		
260-520	520	260	18	25		
280-560	560	300	15	20		
300-600	600	320	13	20		
Alloy	550	340	16	35	0	27
	600	400	16	35		
	650	450	14	32		
	700	540	12	28		

1) PRS may require that a minimum value of tensile strength not be exceeded by more than 150 MPa.  
2) Special consideration may be given to alternative requirements for Charpy V-notch impact test, depending on design and application and subject to agreement with PRS.  
3) AT refers to ambient temperature (i.e. 23°C±5°C) which is specified in ISO 148-1:2016

**13.1.7.2** Mechanical properties shall fulfil the requirements specified in Tables 13.1.7.1-1 and 13.1.7.1-2 appropriate to the minimum tensile strength or, where applicable, the requirements of the approved specification.

**Note 3:** See also sections 13.1.6.4

**13.1.7.3** Where the results of tensile tests fail to meet the relevant requirements specified in the Rules, retests shall be performed in accordance with the requirements specified in sub-chapter 2.3 of this Part.

**13.1.7.4** The additional tests mentioned in paragraph 13.1.7.3 shall be made on specimens taken preferably from the same, but alternatively from another, test sample representative of the casting or batch of castings.

**13.1.7.5** At the option of the manufacturer, where a casting or batch of castings has failed to meet the test requirements specified in the Rules, it may be reheat-treated and resubmitted for acceptance tests.

### 13.1.8 Inspection of Surface and Work Quality

**13.1.8.1** All castings shall be cleaned and adequately prepared for examination; suitable methods include pickling, caustic cleaning, wire brushing, local grinding, shot or sand blasting. The surfaces shall not be hammered, peened or treated in any way which may obscure defects.

**13.1.8.2** Before acceptance, all castings shall be presented to PRS Surveyor for visual examination. Where applicable, this shall include the examination of internal surfaces. Unless otherwise agreed, the verification of dimensions is the responsibility of the manufacturer.

**13.1.8.3** Where required by the relevant Rules, or by the approved procedure for welded composite elements (see paragraph 13.1.2.4), appropriate non-destructive testing shall also be performed before acceptance and the results shall be reported by the manufacturer. Testing requirements and acceptance criteria for non-destructive testing of steel castings for hull components are specified in Publication 71/P – Non-destructive Testing of Hull Marine Steel Castings.

**13.1.8.4** Where required in the relevant chapters of the Rules, castings shall be pressure tested before final acceptance. These tests shall be performed in the presence of PRS Surveyor.

**13.1.8.5** In the event of any casting proving to be defective during subsequent machining or testing, it shall be rejected notwithstanding any previous certification.

### **13.1.9 Rectification of Defective Castings**

**13.1.9.1** Where castings are to be repaired, the manufacturer shall exercise robust controls of all repair operations regarding the repair of castings, with respect of dimensions, heat treatment, inspection and quality control.

**13.1.9.2** The PRS approval is to be obtained where steel castings from which defects were removed are to be used with or without weld repair.

**13.1.9.3** Defects and unacceptable indications shall be repaired as indicated below: Defective parts of the material may be removed by grinding, or by chipping and grinding, or by arc air-gouging and grinding. Thermal methods of metal removal shall be only allowed before the final heat treatment. All grooves shall have a bottom radius of approximately three times the groove depth and shall be smoothly blended to the surface area with a finish equal to that of the adjacent surface.

**13.1.9.4** Non-destructive testing of steel castings after repair shall be carried out in accordance with 13.1.8.3.

**13.1.9.5** Where the defective area is to be repaired by welding, the excavations are to be suitably shaped to allow good access for welding. The resulting grooves are to be subsequently ground smooth and complete elimination of the defective material is to be verified by MT or PT.

**13.1.9.6** Shallow grooves or depressions resulting from the removal of defects may be accepted provided that they will cause no appreciable reduction in the strength of the casting, or affect the intended use, and the depth of defect removal is not over 15 mm or 10% of wall thickness, whichever is less. The resulting grooves or depressions are to be subsequently ground smooth and complete elimination of the defective material is to be verified by MT or PT. Small surface irregularities sealed by welding are to be treated as weld repairs, see 13.1.9.7.

### **13.1.9.7 Weld Repairs**

In addition to the requirements given in 13.1.9.1÷13.1.9.6, the following apply for weld repairs:

**13.1.9.7.1** For C and C-Mn steel castings weld repairs shall be suitably classified as major or minor. For alloy steel castings, repair requires approval from PRS.

Major repairs are those where:

- the depth is greater than 25% of the wall thickness or 25 mm whichever is less, or
- the total weld area on a casting exceeds 0.125 m<sup>2</sup> of the casting surface noting that where a distance between two welds is less than their average width, they are to be considered as one weld.

Weld repairs not classified as major are considered as minor and need to be carried out in accordance with a qualified welding procedure.

**13.1.9.7.2** The following is required for major repairs:

- .1** Shall be carried out before the final delivery heat treatment condition
- .2** Shall comply with the requirements given in 13.1.9.7.4

- .3 Before welding is started, full details of the extent and location of the repair, the proposed welding procedure, heat treatment and subsequent inspection procedures are to be submitted to PRS for approval.

**13.1.9.7.3** The following is required for minor repairs:

- .1 Shall be carried out before the final delivery heat treatment condition
- .2 Shall comply with the requirements given in 13.1.9.7.4 (also with respect to records, see 13.1.9.7.4.6 and .7).
- .3 With the exception of alloy steels, do not require prior approval by PRS, except as given in .4.
- .4 PRS may request minor repairs in critical areas to be treated as major repairs.

**13.1.9.7.4** The following requirements apply for all weld repairs (major and minor):

- .1 All castings in alloy steels and all castings for crankshafts are to be suitably pre-heated prior to welding. Castings in carbon or carbon-manganese steel may also require to be pre-heated depending on their chemical composition and the dimensions and position of the weld repairs.
- .2 Welding procedures are to be qualified and shall match the delivery condition of the casting. Qualification of welding procedures shall meet the requirements of Publication No. 74/P or a recognised standard, e.g. ISO 11970:2016.
- .3 Welding shall be done under cover in positions free from draughts and adverse weather conditions by qualified welders with adequate supervision. As far as possible, all welding shall be carried out in the downhand (flat) position.
- .4 The welding consumables used shall be of an appropriate composition, giving a weld deposit with mechanical properties similar and in no way inferior of those of the parent castings. Welding procedure tests shall be carried out by the manufacturer to demonstrate that satisfactory mechanical properties can be obtained after heat treatment as detailed in 13.1.5.1.
- .5 After welding has been completed the castings are to be given either a suitable heat treatment in accordance with the requirements of 13.1.5.1 or a stress relieving heat treatment at a temperature of not less than 550°C for C and C-Mn steel castings. For alloy steel castings, the heat treatment shall be agreed with PRS. The type of heat treatment employed will be dependent on the chemical composition of the casting and the dimensions, positions and nature of the repairs, and should not affect the properties of the casting. Subject to the prior agreement of PRS, special consideration may be given to omission of post weld heat treatment or to the acceptance of local stress-relieving heat treatment where the repaired area is small and machining of the casting has reached an advanced stage.
- .6 On completion of heat treatment the weld repairs and adjacent material are to be ground smooth and examined by magnetic particle or liquid penetrant testing. Supplementary examination by ultrasonic or radiographic testing may also be required depending on the dimensions and nature of the original defect. Satisfactory results shall be obtained from all forms of non-destructive testing used.
- .7 The manufacturer shall maintain full records detailing the extent and location of repairs made to each casting and details of welding procedures and heat treatments applied for repairs. These records are to be available to PRS Surveyor and copies provided on request.

**13.1.9.7.5** For steels with  $C \geq 0.23$  or  $CEV \geq 0.45$ , the WPQT on which the WPS is based, should be qualified on a base material having a CEV as follows: the CEV of the base material should not fall below more than 0.02 of the material to be welded (example: WPQT for a material with actual  $CEV = 0.50$  may be qualified on a material with  $CEV \geq 0.48$ ).

### 13.1.10 Marking

**13.1.10.1** The manufacturer shall adopt a system of identification which will enable all finished castings to be traced to the original cast and PRS Surveyor shall be given full facilities for so tracing the castings when required.

**13.1.10.2** Marking of steel castings shall fulfil the requirements specified in sub-chapter 1.9 of This Part.

**13.1.10.3** Where small castings are manufactured in large numbers, modified arrangements for identification are subject to PRS acceptance in each particular case.

### 13.1.11 Inspection Certificate

For steel castings, PRS issues an *Inspection Certificate* in accordance with the requirements specified in sub-chapter 1.8 of *this Part*. In addition to the particulars specified in sub-chapter 1.8 of *this Part*, the following information shall be included in the *Inspection Certificate*:

- .1 results of non-destructive tests, where applicable,
- .2 details of heat treatment, including temperature and holding times.
- .3 pressure test results, where applicable.

## 13.2 Cast Stainless Steel Propellers

### 13.2.1 General Requirements

**13.2.1.1** The present requirements apply to the manufacture of cast steel propellers, blades and bosses.

**13.2.1.2** Alloys whose chemical composition, mechanical properties and heat treatment do not fulfil the requirements specified in sub-chapter 13.2 are subject to PRS acceptance in each particular case.

**13.2.1.3** These requirements also apply to the repair of propellers damaged in service, which may be performed subject to prior acceptance by PRS in each particular case.

**13.2.1.4** Each casting shall have a workmanlike finish and shall be free from imperfections and defects which would be prejudicial to their proper application in service.

Minor casting defects which may still be visible after machining such as small sand and slag inclusions, small cold shuts and scabs shall be trimmed off by the manufacturer in accordance with 13.2.9.

**13.2.1.5** Casting defects which may impair the serviceability of the castings, e.g. major non-metallic inclusions, shrinkage cavities, blow holes and cracks, are not permitted. They may be removed by one of the methods described in 13.2.9 and repaired within the limits and restrictions for the severity zones. Full description and documentation must be available for the surveyor.

### 13.2.2 Foundry Approval

**13.2.2.1** Propellers and their components shall be manufactured by foundries approved by PRS. The castings are to be manufactured and tested in accordance with the requirements of this sub-chapter.

#### 13.2.2.2 Application for approval

It is the manufacturer's responsibility to assure that effective quality, process and production controls during manufacturing are adhered to within the manufacturing specification. The manufacturing specification shall be submitted to PRS at the time of initial approval, and shall at

least include the following particulars: description of the foundry facilities, steel material specification, runner and feeder arrangements, manufacturing procedures, non-destructive testing and repair procedures.

### 13.2.2.3 Scope of the approval test

The scope of the approval test is to be agreed with PRS. This should include the presentation of cast test coupons of the propeller materials in question for approval testing in order to verify that the chemical composition and the mechanical properties of these materials comply with these rules.

### 13.2.2.4 Inspection facilities

The foundry shall have an adequately equipped laboratory, manned by experienced personnel, for the testing of moulding materials, chemical analyses, mechanical testing, microstructural testing of metallic materials and non-destructive testing. Where testing activities are assigned to other companies or other laboratory, additional information required by PRS shall be included.

## 13.2.3 Chemical Composition

**13.2.3.1** Typical cast steel propeller alloys are grouped into four types depending on their chemical composition as given in Table 13.2.3.1. Cast steel whose chemical composition deviate from the typical values of Table 13.2.3.1 shall be specially approved by PRS.

**Table 13.2.3.1**  
**Typical chemical composition for stainless steel propeller castings**

Alloy type (designation)	C [%] max	Mn [%] max	Cr [%]	Mo <sup>1)</sup> [%] max	Ni [%]
Martensitic (12Cr1Ni)	0.15	2.0	11.5÷17.0	0.5	max 2.0
Martensitic (13Cr4Ni)	0.06	2.0	11.5÷17.0	1.0	3.5÷5.0
Martensitic (16Cr5Ni)	0.06	2.0	15.0÷17.5	1.5	3.5÷6.0
Austenitic (19Cr11Ni)	0.12	1.6	16.0÷21.0	4.0	8.0÷13.0

<sup>1)</sup> The minimum values shall be in accordance with the recognised national or international standards.

**13.2.3.2** The manufacturer shall maintain records of the chemical analyses of the production casts, which shall be made available to the Surveyor so that he can satisfy himself that the chemical composition of each casting is within the specified limits.

### 13.2.4 Heat Treatment

Martensitic castings shall be austenitised and tempered. Austenitic castings shall be solution treated. Heat treatment particulars are determined by the manufacturer taking account of the chemical composition, shape, size and required mechanical properties of the casting.

## 13.2.5 Mechanical Properties

**13.2.5.1** The mechanical properties are to comply with values given in Table 13.2.5.1.

**Table 13.2.5.1**  
**Mechanical properties for typical stainless steel propeller castings**

Alloy type (designation)	R <sub>p0.2</sub> [MPa] min.	R <sub>m</sub> [MPa] min.	A [%] min.	Z [%] min.	KV <sup>1)</sup> [J] min.
12Cr1Ni	440	590	15	30	20
13Cr4Ni	550	750	15	35	30

Alloy type (designation)	$R_{p0.2}$ [MPa] min.	$R_m$ [MPa] min.	$A$ [%] min.	$Z$ [%] min.	$KV$ <sup>1)</sup> [J] min.
16Cr5Ni	540	760	15	35	30
19Cr11Ni	180 <sup>2)</sup>	440	30	40	–

<sup>1)</sup> Not required for general service and the lowest ice class notations (i.e. L3 or L4).  
For other ice class notations, tests shall be performed at temperature of  $-10$  °C.  
<sup>2)</sup>  $R_{1.0}$  min. = 205 MPa.

**13.2.5.2** Mechanical properties shall be determined on test specimens machined from integrally cast test bars attached to the hub or on the blade. The thickness of test bar is to be in accordance with a recognized standard. Where possible, the test bars attached on blades shall be located in an area between 0.5 and 0.6R (where R is the propeller radius). The test bars shall not be detached from the casting until the final heat treatment has been performed. Removal shall be by non-thermal procedures.

**13.2.5.3** In justified cases, separately cast test bars may be used subject to PRS acceptance in each particular case. The test bars shall be cast from the same heat as the castings represented and heat treated with the castings represented.

**13.2.5.4** At least one set of mechanical test specimens (one tensile test specimen and three impact test specimens, except for austenitic steel castings, for which impact tests are not required) shall be made on material representing each casting. The tests shall be performed in accordance with the requirements specified in Chapter 2 of this Part.

**13.2.5.5** Where a number of small propellers of about the same size and less than 1 m in diameter are made from one cast and heat treated in the same furnace charge, a batch testing procedure may be adopted using separately cast test samples of the shape and dimensions in accordance with Fig. 17.3.6.1 in this Part. At least one set of mechanical test specimens shall be taken for each multiple of five castings in the batch.

### 13.2.6 Inspection of Surface and Work Quality

**13.2.6.1** Finished castings shall be 100% visually inspected by PRS Surveyor who may require some areas to be etched for the purpose of investigating weld repairs.

**13.2.6.2** Castings shall be free from cracks, hot tears or other imperfections which, due to their nature, degree or extent, will interfere with the use of castings.

**13.2.6.3** The verification of dimensions, the dimensional and geometrical tolerances is the responsibility of the manufacturer. The report on the relevant examinations is to be submitted to PRS Surveyor, who may require checks to be made in his presence.

**13.2.6.4** Static balancing shall be performed on all propellers in accordance with the approved drawing. Dynamic balancing is necessary for propellers running above 500 rpm.

### 13.2.7 Non-destructive Testing

#### 13.2.7.1 Definiton of skew, severity zones

In order to relate the degree of non-destructive testing to the criticality of imperfections, propeller blades are divided into three severity zones designated A, B and C. Further, a distinction is made between low skew and high skew propellers in *Publication 7/P – Repair of Cast Copper Alloy Propellers*.

### 13.2.7.2 Qualification of personnel involved in NDT

Personnel shall be certified according to the requirements of *Publication No. 51/P – Procedural Requirements for Service Suppliers*.

### 13.2.7.3 Visual testing

All finished castings shall be 100% visually inspected by the manufacturer. Castings shall be free from cracks, hot tears or other imperfections which, due to their nature, degree or extent, will interfere with the use of castings. A general visual examination shall be carried out by PRS surveyor.

### 13.2.7.4 Liquid penetrant testing

Liquid penetrant testing procedure shall be submitted to PRS and is to be in accordance with ISO 3452-1:2013 or a recognized standard. The acceptance criteria are specified in 13.2.8.

For all propellers, separately cast blades and hubs, the surfaces covered by severity zones A, B and C shall be liquid penetrant tested. Testing of zone A shall be undertaken in the presence of the Surveyor, whilst testing of zone B and C may be witnessed by the Surveyor upon his request.

If repairs have been made either by grinding or by welding, the repaired areas are additionally to be subjected to the liquid penetrant testing independent of their location and/or severity zone. Weld repairs shall, independent of their location, always be assessed according to zone A.

### 13.2.7.5 Magnetic particle testing

Magnetic particle testing may be used in lieu of liquid penetrant testing for examination of martensitic stainless steels castings.

Magnetic particle testing procedure shall be submitted to PRS and shall be in accordance with ISO 9934-1:2016 or a recognized standard.

### 13.2.7.6 Radiographic and ultrasonic testing

When required by PRS or when deemed necessary by the manufacturer, further non-destructive testing (e.g. radiographic and/or ultrasonic testing) shall be carried out. The acceptance criteria or applied quality levels shall then be agreed between the manufacturer and PRS in accordance with a recognized standard.

**Note:** due to the attenuating effect of ultrasound within austenitic steel castings, ultrasonic testing may not be practical in some cases, depending on the shape/type/thickness, and grain-growth direction of the casting.

## 13.2.8 Acceptance criteria for liquid penetrant testing and magnetic particle testing

### 13.2.8.1 Definitions of liquid penetrant indications

**Indication:** In the liquid penetrant testing an indication is the presence of detectable bleed-out of the penetrant liquid from the material discontinuities appearing at least 10 minutes after the developer has been applied.

**Relevant indication:** only indications which have any dimension greater than 1.5 mm shall be considered relevant for the categorization of indications.

**Non-linear indication:** an indication with a largest dimension less than three times its smallest dimension (i.e.  $l < 3 w$ ).

**Linear indication:** an indication with a largest dimension three or more times its smallest dimension (i.e.  $l \geq 3 w$ ).



Aligned indications:

- a) Non-linear indications form an alignment when the distance between indications is less than 2mm and at least three indications are aligned. An alignment of indications is considered to be a unique indication and its length is equal to the overall length of the alignment.
- b) Linear indications form an alignment when the distance between two indications is smaller than the length of the longest indication.

Illustration of liquid penetrant indications is given in Fig. 13.2.8.1.

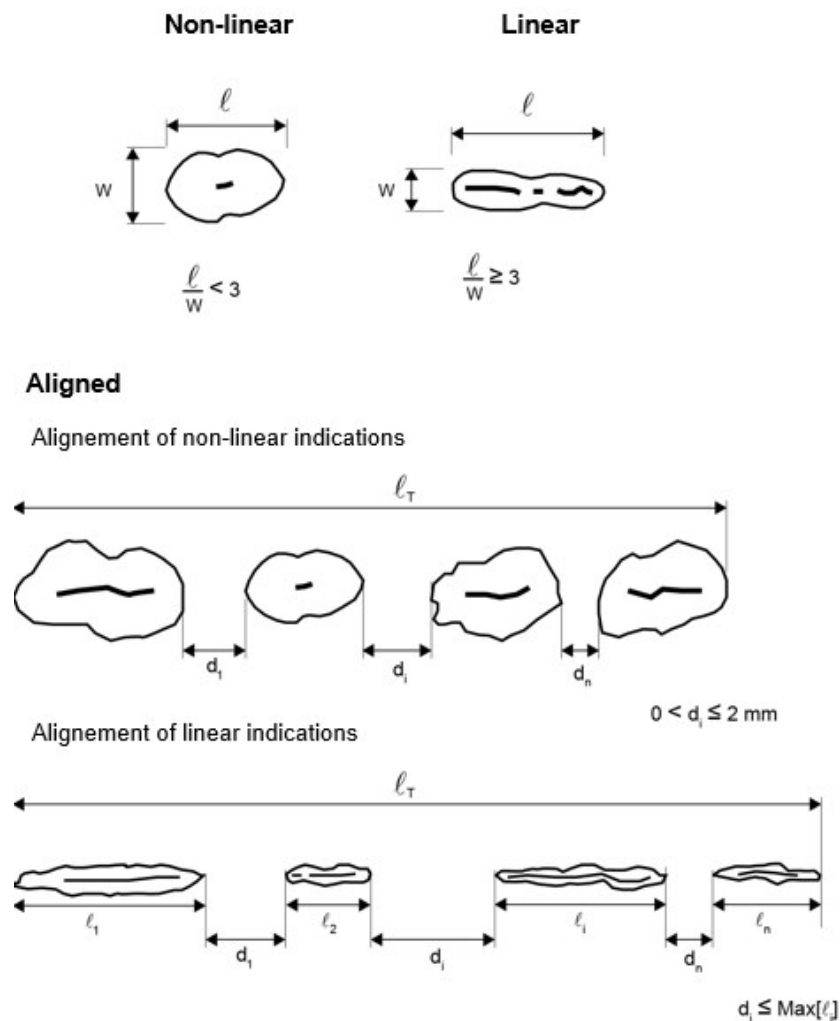

Fig.13.2.8.1 Shape of indications

### 13.2.8.2 Acceptance standard

The surface to be inspected shall be divided into reference areas of 100 cm<sup>2</sup>. Each reference area may be square or rectangular with the major dimension not exceeding 250 mm.

The area shall be taken in the most unfavourable location relative to the indication being evaluated.

The relevant indications detected shall with respect to their size and number, not exceed the values given in the Table 13.2.8.2.

Areas which are prepared for welding are independent of their location shall always be assessed according to zone A. The same applies to the welded areas after being finished machined and/or grinded.

**Table 13.2.8.2**  
**Allowable number and size of relevant indications in reference areas of 100 cm<sup>2</sup>**  
**depending on severity zones**

Severity zone	Maximum total number of indications	Indication type	Maximum number for each type <sup>1), 2)</sup>	Maximum dimension <i>l</i> <sup>3)</sup> [mm]
A	7	non-linear	5	4
		linear	2	3
		aligned	2	3
B	14	non-linear	10	6
		linear	4	6
		aligned	4	6
C	20	non-linear	14	8
		linear	6	6
		aligned	6	6

<sup>1)</sup> Single non-linear indications less than 2 mm in Zone A and less than 3 mm for the other zones are not considered relevant.  
<sup>2)</sup> The total number of non-linear indications may be increased to the maximum total number, or part thereof, represented by the absence of linear or aligned indications.  
<sup>3)</sup> *l* – dimension of non-linear indication main axis or length of non-linear indication.

### 13.2.9 Repair of defects

**13.2.9.1** Defective castings shall be repaired in accordance with the requirements specified in Publication 7/P – Repair of Cast Copper Alloy Propellers and in sub-chapter 23.9 of this Part, where applicable.

**13.2.9.2** Martensitic steels shall be furnace re-tempered after weld repair. Local stress relieving may, however, be considered for minor repairs subject to prior acceptance by PRS in each particular case.

**13.2.9.3** The foundry shall maintain records of welding, subsequent heat treatment and inspections, traceable to each casting repaired. These records shall be reviewed by PRS Surveyor.

### 13.2.10 Marking

**13.2.10.1** The manufacturer shall adopt a system for the identification of all castings, which enable the material to be traced to its original cast. PRS Surveyor shall be given full facilities for so tracing the castings when required.

Each finished casting propeller shall be marked by the manufacturer at least with the following particulars:

- a) Heat number or other marking which will enable the full history of the casting to be traced;
- b) Grade of cast material or corresponding abbreviated designation
- c) PRS certificate number;
- d) Ice class symbol, where applicable;
- e) Skew angle for high skew propellers,
- f) Date of final inspection.

**13.2.10.2** The Society's stamp is to be put on when the casting has been accepted.

### 13.2.11 Inspection Certificate

For propellers, PRS issues *Inspection Certificate* in accordance with the requirements specified in sub-chapter 1.8 of *this Part*. In addition to the particulars specified in sub-chapter 1.8 of *this Part*, the following information shall be included in the *Inspection Certificate*:

- .1 purchaser's name and order number,
- .2 vessel identification, where known,
- .3 description of the casting with drawing number,
- .4 diameter, number of blades, pitch, direction of turning,
- .5 skew angle for high skew propellers (for propellers with a skew angle exceeding 25°),
- .6 final weight,
- .7 casting identification number,
- .8 details of time and temperature of heat treatment,
- .9 statement regarding non-destructive testing and details of the test procedure, if necessary,
- .10 records of weld repairs in accordance with the requirements specified in paragraph 13.2.9.3.

## 14 GREY IRON CASTINGS

### 14.1 General Requirements

**14.1.1** Important grey iron castings intended for hull structural members and ship machinery, subject to PRS survey specified in the relevant Parts of the Rules, shall be manufactured and tested in accordance with the requirements of the present Chapter.

**14.1.2** Subject to PRS consent, series-manufactured grey iron castings may be tested and accepted in accordance with individual procedures.

**14.1.3** Depending on the specified minimum tensile strength, grey iron is subdivided into grades.

### 14.2 Manufacture

**14.2.1** Important grey iron castings shall be made at foundries approved by PRS and according to manufacturing process agreed with PRS.

**14.2.2** Suitable mechanical methods shall be employed for the removal of surplus material from castings. Thermal cutting processes are not acceptable, except as a preliminary operation to mechanical methods.

**14.2.3** Where castings of the same type are regularly produced in quantity, the manufacturer shall perform any tests necessary to prove the quality of the prototype castings and shall also carry out periodical examinations to verify the continued efficiency of the manufacturing technique. PRS Surveyor shall be given the opportunity to witness these tests.

### 14.3 Quality of Castings

Castings shall be free from surface or internal defects which would be prejudicial to their proper application in service. The surface finish shall be in accordance with good practice and requirements specified in the approved quality control plan.

### 14.4 Chemical Composition

The chemical composition of grey iron castings is left to the discretion of the manufacturer, who shall ensure that it is suitable for the required mechanical properties of the castings.

PRS may require that the chemical composition, according to the ladle analysis, should be stated in *Inspection Certificate*.

### 14.5 Supply Condition

**14.5.1** Except as required by paragraph 14.5.2, castings may be supplied in either the as cast or heat treated condition.

**14.5.2** For some applications, such as high temperature service or where dimensional stability is important, castings may require to be given a suitable tempering or stress relieving heat treatment. Stress relief annealing shall be performed prior to heat treatment procedure for refining the structure and improvement of mechanical properties.

### 14.6 Mechanical Tests

**14.6.1** Test sample sufficient for the required tests and for possible re-tests shall be provided for each casting or a batch of castings.

**14.6.2** Unless agreed otherwise between the manufacturer and the purchaser, test sample shall be in the form of cylindrical bar of suitable length and 30 mm in diameter according to PN-EN 1561 (Fig. 14.6.2). Length  $L$  shall be determined depending on the length of tensile test specimen and the testing machine grips.

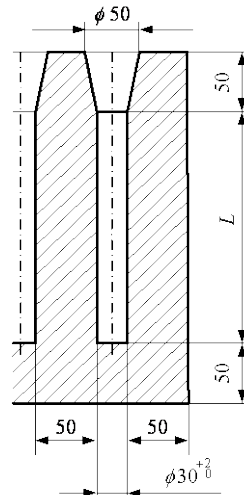

Fig. 14.6.2. Test sample mould

It shall be cast vertically in a mould made from the same type of material as used for the casting and shall be removed from the mould at the temperature not exceeding 500°C.

When two or more test samples are cast simultaneously in a single mould, the bars shall be at least 50 mm apart.

**14.6.3** Integrally cast samples may be used if the thickness of the casting wall exceeds 20 mm and the castings mass exceeds 200 kg, subject to agreement between the manufacturer and the purchaser.

Types of integrally cast samples and strength properties of specimens made from integrally cast samples, recommended by PN-EN 1561 are given in Fig. 14.6.3. Type 1 test sample shall be used for castings with the wall thickness up to 80 mm. Type 2 test sample shall be used for castings with the wall thickness exceeding 80 mm.

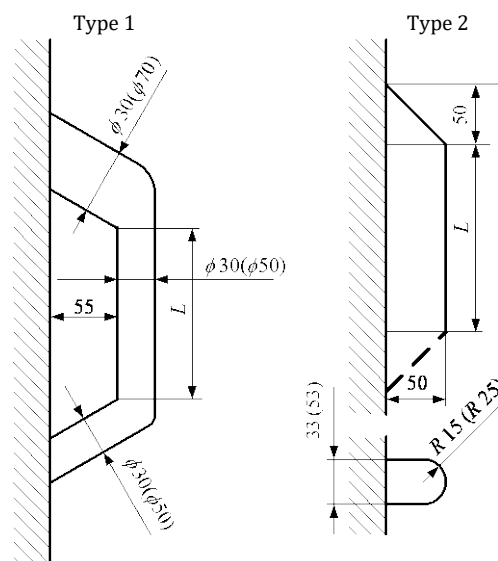

Fig. 14.6.3. Integrally cast samples

**14.6.4** Except as required by paragraph 14.6.7, at least one test sample shall be cast with each batch.

**14.6.5** Except as required by paragraph 14.6.6, a batch consists of the castings poured from a single ladle of metal, provided they are all of similar type and dimensions. A batch should not normally exceed 2000 kg of fettled castings. A single casting will constitute a batch if its mass is 2000 kg or more.

**14.6.6** For continuous melting of the same grade of cast iron, the castings manufactured within 2 hours may, upon PRS consent, constitute one batch.

**14.6.7** If one grade of cast iron is melted in large quantities and its manufacture is monitored by systematic checking the melting process, such as chill testing, chemical analysis or thermal analysis, test samples may be taken at longer intervals.

**14.6.8** All test samples shall be suitably marked to identify them with the castings which they represent.

**14.6.9** Where castings are supplied in the heat treated condition, the test samples shall be heat treated together with the castings which they represent. For integrally cast samples, the sample shall not to be cut off from the casting until heat treatment has been completed.

**14.6.10** At least one tensile test specimen shall be prepared from each test sample. The dimensions of tensile test specimens shall be in accordance with the requirements of Chapter 2, this Part. Test samples of other dimensions may be permitted, subject to the prior agreement with PRS.

**14.6.11** All tensile tests shall be performed in accordance with the requirements of Chapter 2, this Part. Unless agreed otherwise, all tests shall be performed in the presence of PRS Surveyor.

## 14.7 Mechanical Properties

**14.7.1** The basis of acceptance of grey cast iron is the tensile strength determined from the tests on a specimen with the dimensions according to the requirements of 2.5.4, this Part. The specified minimum tensile strength shall be given in the documentation subject to PRS approval, but it shall be not less than 200 MPa.

In Table 14.7.1, the values of  $R_m$ , determined on specimens taken from separately cast test samples, are given.

The mechanical properties of specimens, cut out directly from the castings, shall be specially agreed with PRS.

**Table 14.7.1**  
**Tensile strength of grey cast iron**

Grey cast iron grade	$R_m$ [MPa] min.	Grey cast iron designation acc. to PN-EN1561
200	200	EN-GJL-200
250	250	EN-GJL-250
300	300	EN-GJL-300
350	350	EN-GJL-350

**14.7.2** The mechanical properties of specimens cut out from integrally cast samples (Fig. 14.6.3) are given in Table 14.7.2.

**Table 14.7.2**  
**Tensile strength of specimens made of integrally cast samples**  
**depending on the casting wall thickness**

Grey cast iron grade	Casting wall thickness, $t$ [mm]	Tensile strength $R_m$ [MPa] min.	
		Integrally cast specimen	Specimen cut from the casting (for information only)
200	$20 < t \leq 40$	170	155
	$40 < t \leq 80$	150	130
	$80 < t \leq 150$	140	115
	$150 < t \leq 300$	130	-
250	$20 < t \leq 40$	210	195
	$40 < t \leq 80$	190	170
	$80 < t \leq 150$	170	155
	$150 < t \leq 300$	160	-
300	$20 < t \leq 40$	250	240
	$40 < t \leq 80$	220	210
	$80 < t \leq 150$	210	195
	$150 < t \leq 300$	190	-
350	$20 < t \leq 40$	290	280
	$40 < t \leq 80$	260	250
	$80 < t \leq 150$	230	225
	$150 < t \leq 300$	210	-

**14.7.3** The fractured surfaces of all tensile test specimens shall be granular and grey in appearance.

**14.7.4** Re-test requirements for mechanical tests are given in 2.3.1, this *Part*.

## 14.8 Inspection of Surface and Work Quality

**14.8.1** All castings shall be cleaned and adequately prepared for examination. The surfaces shall not be hammered, peened or treated in any way which may obscure defects.

**14.8.2** Before acceptance, all castings shall be visually examined, including, where applicable, the examination of internal surfaces. Unless otherwise agreed, the verification of dimensions is the responsibility of the manufacturer.

**14.8.3** Where there is any doubt as to the soundness of the casting, supplementary examination by suitable non-destructive test is required.

**14.8.4** Where required by the relevant Chapters of the Rules, castings shall be pressure tested before the final acceptance.

**14.8.5** In the event of any casting proving defective during subsequent machining or testing, it shall be rejected notwithstanding the preceding acceptance procedure.

## 14.9 Rectification of Defective Castings

**14.9.1** Subject to agreement with PRS Surveyor, small surface blemishes may be removed by local grinding.

**14.9.2** Subject to agreement with PRS Surveyor, castings containing local porosity may be rectified by impregnation with a suitable plastic filler, provided that the extent of the porosity is such that it does not adversely affect the strength of the casting.

**14.9.3** Repairs by welding are not permitted.

#### **14.10 Marking**

**14.10.1** The manufacturer shall adopt a system of identification, which will enable all finished castings to be traced back to the original ladle of metal. PRS Surveyor shall be given full facilities for so tracing the castings when required.

**14.10.2** Grey iron castings shall be marked in accordance with the requirements of sub-chapter 1.9, this Part. Additionally, the marking shall contain pressure test results, including test pressure.

**14.10.3** Where small castings are manufactured in large numbers, modified arrangements for identification shall be specially agreed with PRS.

#### **14.11 Inspection Certificate**

For accepted castings, *Inspection Certificate* is issued by PRS in accordance with the requirements of sub-chapter 1.8, *Part IX*. In addition to particulars specified in sub-chapter 1.8, *Part IX*, *Inspection Certificate* shall contain the following information:

- .1 general details of heat treatment, where applicable,
- .2 pressure test results, where applicable,
- .3 the chemical analysis of ladle samples, where applicable.



## 15 NODULAR IRON CASTINGS

### 15.1 General Requirements

**15.1.1** Important nodular graphite iron castings intended for hull structural members and ship machinery, subject to the survey specified in the relevant Parts of the *Rules*, shall be manufactured and tested in accordance with the requirements of the present Chapter.

**15.1.2** The requirements of the present Chapter are applicable to nodular iron castings intended for hull structural members and ship machinery where the design and acceptance test are related to mechanical properties at ambient temperature. The requirements for nodular iron castings intended for service at low or elevated temperatures shall be specially agreed with by PRS.

**15.1.3** Subject to agreement with PRS, series-manufactured nodular iron castings may be inspected and accepted in accordance with individual procedures.

**15.1.4** Depending on the specified minimum tensile strength, nodular iron castings are subdivided into grades (Table 15.7.1).

### 15.2 Manufacture

**15.2.1** Important nodular iron castings shall be made at foundries approved by PRS and according to manufacturing process agreed with PRS.

**15.2.2** Suitable mechanical methods shall be employed for the removal of surplus material from castings. Thermal cutting processes are not acceptable, except as a preliminary operation to mechanical methods.

**15.2.3** Where castings of the same type are regularly produced in series, the manufacturer shall perform any tests necessary to prove the quality of the prototype castings and shall also carry out periodical examinations to verify the continued efficiency of the manufacturing process. PRS Surveyor shall be given the opportunity to witness these tests.

### 15.3 Quality of Castings

Castings shall be free from surface or internal defects which would be prejudicial to their proper application in service. The surface finish shall be in accordance with good practice and the requirements specified in the approved quality control plan.

### 15.4 Chemical Composition

Unless agreed otherwise, the chemical composition of nodular iron castings is left to the discretion of the manufacturer, who shall ensure that it is suitable for the required mechanical properties of the castings.

PRS may require that the chemical composition, according to the ladle analysis, should be stated in *Inspection Certificate*.

### 15.5 Supply Condition

**15.5.1** Except as required by 15.5.2, castings may be supplied in either the as cast or heat treated condition. The type and method of heat treatment is left to the discretion of the manufacturer, depending on the chemical composition, designation and shape of the casting.

**15.5.2** For some applications, such as high temperature service or where dimensional stability is important, it may be required that castings should be subjected to a suitable tempering or stress relieving heat treatment. This shall be performed after any refining heat treatment and before machining. Grade 350-22 and 400-18 nodular iron castings shall undergo a ferritizing heat treatment.

**15.5.3** Where it is proposed to locally harden the surface of a casting, details of the proposed procedure shall be agreed with PRS.

**15.6 Mechanical Tests**

**15.6.1** Test sample sufficient for the required tests and for possible re-tests shall be provided for each casting or a batch of castings.

**15.6.2** The samples cast separately shall be of the dimensions as specified in Figs. 15.6.2-1, 15.6.2-2 and 15.6.2-3; the length  $L$  of a sample shall be according to the sample dimensions and the type of the testing machine.

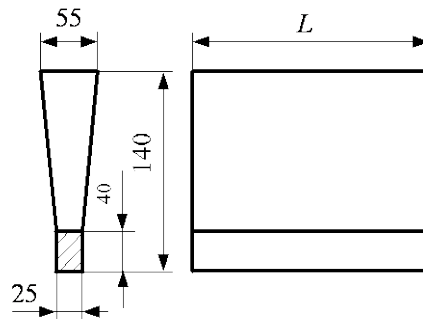

Fig. 15.6.2-1

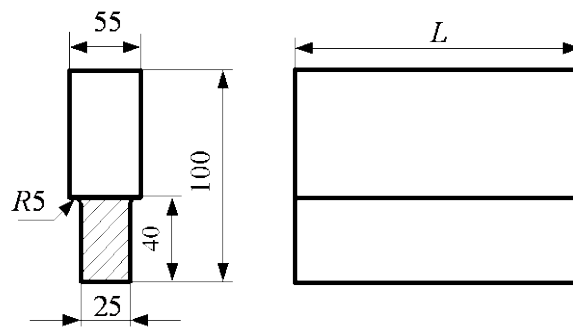

Fig. 15.6.2-2

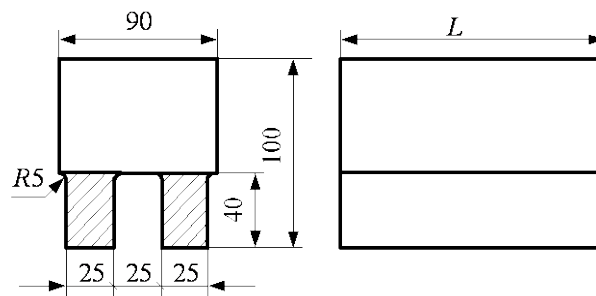

Fig. 15.6.2-3

**15.6.3** At least one test sample shall be provided for each casting. Test samples may be either gated to the casting or separately cast.

Subject to agreement with PRS, other types of test samples may be used, or – in the case of batch of castings acceptance – the samples may be cut out directly from the casting constituting a batch.

**15.6.4** For large castings where more than one ladle of treated metal is used, additional test samples shall be provided so as to be representative of each ladle used.

**15.6.5** As an alternative to the requirements of para. 15.6.3, a batch testing procedure may be adopted for castings with a fettled mass of 1000 kg or less. All castings in a batch shall be of similar type and dimensions, cast from the same ladle of treated metal. One separately cast test sample shall be provided for each multiple of 2000 kg of fettled castings in the batch.

**15.6.6** Where separately cast test samples are used, they shall be cast in moulds made from the same type of material as used for the castings. Test samples shall not be stripped from the moulds until the temperature is below 500°C.

**15.6.7** All test samples shall be suitably marked to identify them with the castings which they represent.

**15.6.8** Where castings are supplied in the heat treated condition, the test samples shall be heat treated together with the castings which they represent.

**15.6.9** One tensile test specimen shall be prepared from each test sample and shall be machined to the dimensions given in Chapter 2.

**15.6.10** All tensile tests shall be performed in accordance with the requirements of Chapter 2, this Part. Unless agreed otherwise, all tests shall be performed in the presence of PRS Surveyor.

**15.6.11** Impact tests may additionally be required. In such cases a set of three test specimens of agreed type shall be prepared from each sample. Where Charpy V-notch test specimens are used, the dimensions and testing procedures shall be in accordance with Chapter 2, this Part.

## 15.7 Mechanical Properties

**15.7.1** Depending on the specified minimum tensile strength, proof stress and elongation shall comply with the requirements of Table 15.7.1. Typical Brinell hardness values, given in the Table, are intended for information purposes only. The requirements given in the Table refer to test specimens prepared from separately cast test samples.

**Table 15.7.1**  
**Mechanical properties of separately cast test samples**

Nodular cast iron grade	Tensile test			Hardness <i>HB</i> (approx. values)	Impact test		Structure <sup>1)</sup>
	<i>R<sub>m</sub></i> <sup>2)</sup> [MPa] min.	<i>R<sub>p0.2</sub></i> [MPa] min.	<i>A</i> [%] min.		Test temp. [°C]	<i>KV</i> <sup>3)</sup> [J] min.	
350-22	350	220	22 <sup>4)</sup>	110÷170	+20	17(14)	F
400-18	400	250	18 <sup>4)</sup>	140÷200	+20	14(11)	F
370-17	370	230	17	120÷180	–	–	F
400-12	400	250	12	140÷200	–	–	F
500-7	500	320	7	170÷240	–	–	F/P
600-3	600	370	3	190÷270	–	–	F/P
700-2	700	420	2	230÷300	–	–	P
800-2	800	480	2	250÷350	–	–	P or T

Notes:

- 1) Structure composition: F – ferrite, P – pearlite, T – tempered
- 2) For intermediate values of  $R_m$ , the values of  $R_{p0.2}$  and  $A_5$  may be determined by linear interpolation.
- 3) Average values obtained from three results. The minimum value of the individual result is given in brackets.
- 4) For integrally cast samples, the value of  $A$  may be lower by 2 units.

**15.7.2** Castings may be supplied to the specified minimum tensile strength other than that given in Table 15.7.1. In such case they are subject to special requirements agreed with PRS.

**15.7.3** Unless agreed otherwise, only the tensile strength and elongation need be determined. The results of all tensile tests shall comply with the requirements of Table 15.7.1.

**15.7.4** Re-test requirements for mechanical tests are given in 2.3.1, this Part.

**15.7.5** The mechanical properties determined on specimens gated to or cut out directly from the casting shall be specially agreed with PRS.

## **15.8 Inspection of Surface and Work Quality**

**15.8.1** All castings shall be cleaned and adequately prepared for examination. The surfaces shall not be hammered, peened or treated in any way which may obscure defects.

**15.8.2** Before acceptance, all castings shall be visually examined, including, where applicable, the examination of internal surfaces. Unless agreed otherwise, the verification of dimensions is the responsibility of the manufacturer.

**15.8.3** Where there is any doubt as to the soundness of the casting, supplementary examination by suitable non-destructive tests is required.

**15.8.4** Where required by the relevant Chapters of the Rules, castings shall be pressure tested before the final acceptance.

**15.8.5** In the event of any casting proving defective during subsequent machining or testing, it shall be rejected notwithstanding the preceding acceptance procedure.

## **15.9 Metallographic Examination**

**15.9.1** For crankshafts, the metallographic examination is mandatory.

**15.9.2** From each test sample, at least one test specimen shall be taken for metallographic examination. Specimens for metallographic examinations may be taken from the tensile strength specimens or from separately cast samples, taken from the same ladle.

**15.9.3** Examination of the samples shall show that at least 90% of the graphite is in a dispersed spheroidal or nodular form. Details of the structure, given in Table 15.7.1, are intended for information purposes only.

## **15.10 Rectification of Defective Castings**

**15.10.1** Subject to agreement with PRS Surveyor, small surface imperfections may be removed by grinding.

**15.10.2** Subject to agreement with PRS Surveyor, castings containing local porosity may be rectified by impregnation with a suitable plastic filler, provided that the extent of the porosity is such that it does not adversely affect the strength of the casting.

**15.10.3** Repairs by welding are not permitted.

## 15.11 Marking

**15.11.1** The manufacturer shall adopt a system of identification, which will enable all finished castings to be traced back to the original ladle of metal. PRS Surveyor shall be given full facilities for so tracing the castings when required.

**15.11.2** Castings shall be marked in accordance with the requirements of sub-chapter 1.9, this Part. Additionally, the marking shall contain pressure test results, including test pressure.

## 15.12 Inspection Certificate

For accepted castings, *Inspection Certificate* is issued by PRS in accordance with the requirements of sub-chapter 1.8, this *Part*. In addition to particulars specified in sub-chapter 1.8, this *Part*, *Inspection Certificate* shall contain the following information:

- .1 general details of heat treatment, where applicable,
  - .2 pressure test results, where applicable,
  - .3 the chemical analysis of ladle samples, where applicable.
-

## 16 MALLEABLE IRON CASTINGS

The chemical composition, mechanical properties and scope of tests of malleable iron castings shall be agreed with PRS.

## 17 COPPER ALLOYS

### 17.1 Copper and Copper Alloy Tubes

#### 17.1.1 General Requirements

**17.1.1.1** The requirements of sub-chapter 17.1 apply to copper and copper alloy tubes used in parts of ship machinery and pipelines manufactured under PRS survey.

**17.1.1.2** The requirements of sub-chapter 17.1 apply to phosphorous-deoxidised copper, aluminium brass and copper-nickel alloys.

**17.1.1.3** Tubes shall be in accordance with the relevant standards, e.g. PN-EN 12449, PN-EN 1057, PN-EN 12451 and the requirements of the present Rules. Recognition of other standards or material specifications shall be specially agreed with PRS.

**17.1.1.4** The use of material differing in chemical composition, mechanical properties or supply condition from the materials listed above shall be subject to special agreement with PRS.

#### 17.1.2 Manufacture

**17.1.2.1** Tubes for Class I and Class II ship's piping systems shall be made at works approved by PRS.

**17.1.2.2** Tubes for Class I and Class II ship's piping systems shall be seamless drawn. Tubes for Class III ship's piping systems may be seamless drawn or welded.

#### 17.1.3 Chemical Composition

**17.1.3.1** The chemical composition of copper and copper alloy tubes shall comply with the requirements of the relevant standards or material specifications agreed with PRS.

**17.1.3.2** The chemical composition limits for principal elements in copper and copper alloy tubes shall comply with the requirements given in Table 17.1.3.2.

**Table 17.1.3.2**  
**Chemical composition limits for principal elements in copper and copper alloy tubes<sup>1)</sup>**

Designation	Cu	Al	As	Fe	Mn	Ni	P	Pb	Zn
Cu-DPH copper (CW024A)	99.9 <sup>2)</sup> min.	-	-	-	-	-	0.015÷0.040	-	-
CuZn20Al2As aluminium brass (CW702R)	76÷79	1.8÷2.3	0.02÷0.06	0.07 max.	0.10 max.	0.10 max.	0.01 max.	0.02 max.	The remainder
CuNi10Fe1Mn copper-nickel alloy <sup>3)</sup> (CW352H)	The remainder	-	-	1.0÷2.0	0.5÷1.5	9÷11	0.02 max.	0.02 max.	0.5 max.
CuNi30Mn1Fe copper-nickel alloy <sup>3)</sup> (CW354H)	The remainder	-	-	0.4÷1.0	0.5÷1.5	30÷32	0.02 max.	0.02 max.	0.5 max.

<sup>1)</sup> Composition in percentage mass by mass maximum unless shown as a range or as a minimum.

<sup>2)</sup> Including Ag up to max. 0.015%.

<sup>3)</sup> When the product is intended for subsequent welding applications, as specified by the purchaser, the following maximum limits shall apply: Zn ≤ 0.05%; P ≤ 0.02 %; S ≤ 0.02 %; C ≤ 0.05 %

#### 17.1.4 Supply Condition

Copper tubes shall be supplied in the annealed or half-hard condition.

Copper alloy tubes shall be supplied in the annealed condition.

#### 17.1.5 Mechanical Properties

**17.1.5.1** The mechanical properties shall be determined by tensile test in accordance with recognized standards on test specimens taken from test samples according to these standards.

**17.1.5.2** The mechanical properties shall comply with the requirements of recognized standards and the values given in Table 17.1.5.2.

**Table 17.1.5.2**  
**Mechanical properties of copper and copper alloy tubes**

Designation	Supply condition	$R_m$ [MPa] min.	$R_{p0.2}$ [MPa] min.	$A$ [%] min.
Cu-DPH copper (CW024A)	annealed	200	100	40
	half-hard	250	150	20
CuZn20Al2As aluminium brass (CW702R)	annealed	330	120	35
CuNi10Fe1Mn copper-nickel alloy (CW352H)	annealed	290	100	30
CuNi30Mn1Fe copper-nickel alloy (CW354H)	annealed	360	120	30

#### 17.1.6 Testing

Tubes shall be submitted for testing in batches. The size of the batch and the scope of the tests shall comply with the requirements of recognized standards or material specifications agreed with PRS.

#### 17.1.7 Inspection of Surface and Work Quality

Surface inspection and verification of dimensions of the finished products are the responsibility of the manufacturer. Acceptance of the tubes by PRS Surveyor does not absolve the manufacturer from this responsibility. Tubes are subject to visual inspection and verification of dimensions for compliance with the requirements of the relevant standards.

Each tube shall be subjected to eddy current testing or pressure testing in accordance with the requirements of recognized standards.

#### 17.1.8 Repair

Defects may be removed by grinding, provided that dimensional tolerances are not exceeded. Repair by welding is not permitted.

#### 17.1.9 Marking

Tubes shall be suitably marked for identification by the manufacturer. Tube marking shall be in accordance with the requirements of sub-chapter 1.9, *Part IX*. Hard stamping of tubes is not permitted.

#### 17.1.10 Inspection Certificate

For each accepted tube, *Inspection Certificate* is issued by PRS in accordance with the requirements of sub-chapter 1.8, *Part IX*. In addition to particulars specified in sub-chapter 1.8, *Part IX*, *Inspection Certificate* shall contain the following information:

- .1 non-destructive tests results, where applicable,
- .2 pressure tests results, where applicable,
- .3 results of any other tests, specified in the order.

## 17.2 Copper Alloy Castings other than Castings for Propellers

### 17.2.1 General Requirements

**17.2.1.1** The requirements of sub-chapter 17.2 are applicable to copper alloy castings subject to PRS manufacture survey, intended for equipment, machinery and piping systems.

**17.2.1.2** The requirements of sub-chapter 17.2 are not applicable to copper alloy castings for propellers.

**17.2.1.3** The requirements of sub-chapter 17.2 apply to brasses, bronzes and copper-nickel alloys.

**17.2.1.4** Copper alloy castings shall be in accordance with recognized standards, e.g. PN-EN 1982 and the requirements of the present Rules. Recognition of other standards or material specifications shall be specially considered by PRS.

**17.2.1.5** The use of material differing in chemical composition, mechanical properties or supply condition from those specified above is subject to special consideration by PRS, having regard to the purpose for which the material is intended.

### 17.2.2 Manufacture

**17.2.2.1** All castings shall be made at foundries approved by PRS.

**17.2.2.2** The melting shall be by induction melting or by gas or oil fired furnaces with a crucible or any other process agreed with PRS.

**17.2.2.3** The mould cavity shall be filled with a laminar flow of metal. The gating, risering and moulding shall be in accordance with good foundry practice.

### 17.2.3 Chemical Composition

**17.2.3.1** The chemical composition of each ladle shall comply with the requirements of the relevant standards or material specifications agreed with PRS.

**17.2.3.2** Where castings are made from alloyed ingots, the chemical composition based on Inspection Certificate can be adopted. If any foundry returns are added to the melt, additional chemical analysis may be required by PRS Surveyor. For parts of machinery which are in direct contact with sea water, the following copper alloys are recommended:

CUSN11P-C, CUSN11PB2-C, CUSN6ZN4PB2-C, CUSN5ZN5PB5-C, CUZN35MN2AL1FE1-C,  
CUZN34MN3AL2FE1-C, CUZN16SI4-C, CUAL10NI3FE2-C, CUZN39PB1ALB-C, CUAL10FE2-C,  
CUAL10FE5NI5-C, CUZN25AL5MN4FE3-C, CUNI10FE1MN1-C, CUNI30FE1MN1-C.

**17.2.3.3** Elements designated as residual elements in specifications shall not be intentionally added to the melt. The content of such elements shall be reported in the chemical composition.

### 17.2.4 Supply Condition

**17.2.4.1** Where castings are supplied in the heat treated condition, the heat treatment shall be performed in a properly constructed furnace which has adequate means for temperature control and is fitted with recording-type pyrometers. The furnace dimensions shall be such as to allow the whole furnace charge to be uniformly heated to the necessary temperature.

**17.2.4.2** Sufficient thermocouples shall be connected to the furnace charge to measure and record the temperature uniformity of the furnace.



**17.2.4.3** The foundry shall maintain records of heat treatment. The records shall contain at least identification of the furnace used, furnace charge, date, holding temperature and time. The records shall be presented to PRS, on request.

**17.2.4.4** If a casting is locally reheated or a straightening operation is performed, stress relieving heat treatment may be required by PRS.

### **17.2.5 Mechanical Tests**

**17.2.5.1** Castings shall be submitted for testing in batches. The size of the batch and the scope of the tests shall comply with the requirements of the relevant standards or material specifications agreed with PRS. From the batch, at least one set of mechanical test specimens shall be taken.

**17.2.5.2** In the case of multiple castings poured from the same ladle, at least one set of mechanical test specimens, representing all castings from that ladle, shall be taken.

**17.2.5.3** Where castings are made from two or more ladles, one set of mechanical test specimens shall be poured from each ladle unless the metal in the ladle comes from the same heat.

**17.2.5.4** Test samples, from which test specimens are taken, shall be cast separately into moulds with gating systems that ensure laminar flow into the mould cavity. The test samples shall receive the same casting practices as the castings they represent.

**17.2.5.5** For centrifugal cast liners and bushes, the test material shall be taken from the ends of the casting.

**17.2.5.6** All test samples shall be suitably marked to identify them with the castings which they represent.

**17.2.5.7** The preparation of test specimens and mechanical tests procedures shall be in accordance with the requirements of Chapter 2, this *Part*.

### **17.2.6 Mechanical Properties**

**17.2.6.1** The mechanical properties shall be determined by tensile test in accordance with Chapter 2, this *Part*, on test specimens prepared from test samples taken in accordance with 17.2.5.

**17.2.6.2** The mechanical properties shall comply with the requirements of the relevant standards or material specifications agreed with PRS.

**17.2.6.3** If the results of mechanical tests do not conform to the requirements of the relevant standards or material specifications agreed with PRS, re-tests shall be performed in accordance with the requirements of sub-chapter 2.3, this *Part*.

### **17.2.7 Inspection of Surface and Work Quality**

**17.2.7.1** All finished castings shall be visually examined on accessible surfaces. The surfaces shall be cleaned and adequately prepared for examination. The surfaces shall not be hammered, peened or treated in any way which may obscure defects.

**17.2.7.2** Before acceptance, castings shall be presented to PRS Surveyor for visual examination. PRS Surveyor may require areas to be etched for the purpose of investigating weld areas.

**17.2.7.3** When visually examined, castings shall be free from adhering sand, scale, cracks, hot tears or other imperfections detrimental to their intended application.

**17.2.7.4** Unless agreed otherwise between the purchaser and the manufacturer, the verification of dimensions is the responsibility of the manufacturer.

**17.2.7.5** Castings shall be subjected to non-destructive tests in accordance with the requirements of Publication 80/P – Non-Destructive Tests.

**17.2.7.6** Where penetrant tests are required, they shall be performed when the surface is in the final condition. Penetrant tests shall be performed in the presence of PRS Surveyor, in accordance with the requirements of PN-EN ISO 3452-1 or ASTM E165-02.

**17.2.7.7** The foundry shall maintain records of examinations traceable to each casting. The records shall be presented to PRS Surveyor, on request. The foundry shall provide the Surveyor with non-destructive tests report confirming that the tests have been performed with satisfactory results.

### **17.2.8 Rectification of Defective Castings**

**17.2.8.1** Defects may be removed by chipping, milling or grinding. Chipping or milling shall be always followed by grinding. The resulting grooves shall have a bottom radius of approximately three times the groove depth and shall be blended into the surrounding surface so as to avoid any sharp contours. The repaired area shall be subjected to penetrant tests.

**17.2.8.2** Where repair by welding is agreed with PRS, the excavations shall be suitably shaped to allow good access for welding.

**17.2.8.3** All weld repairs shall be performed by the manufacturer approved by PRS, in accordance with welding procedures agreed with PRS. Welding consumables shall be suitable for the parent materials used.

**17.2.8.4** Weld repairs and adjacent material shall be ground smooth. All weld repairs shall be subjected to non-destructive tests.

**17.2.8.5** The manufacturer shall maintain records of welding and subsequent heat treatment for each repaired casting. The records shall be presented to PRS Surveyor, on request.

### **17.2.9 Marking**

**17.2.9.1** The manufacturer shall adopt a system of identification, which will enable all finished castings to be traced back to the original ladle of metal. PRS Surveyor shall be given full facilities for so tracing the castings when required.

**17.2.9.2** Castings shall be marked in accordance with sub-chapter 1.9, this *Part*. Additionally, the marking shall contain pressure test results, including test pressure.

### **17.2.10 Inspection Certificate**

For accepted castings, *Inspection Certificate* is issued by PRS in accordance with the requirements of sub-chapter 1.8, this *Part*. In addition to particulars specified in sub-chapter 1.8, this *Part*, *Inspection Certificate* shall contain the following information:

- .1 casting identification number,
- .2 details of heat treatment, including temperatures and holding times,
- .3 non-destructive tests results, where applicable,
- .4 pressure test results, where applicable,
- .5 results of any supplementary tests, where applicable.

## 17.3 Cast Copper Alloys for Propellers

### 17.3.1 General Requirements

**17.3.1.1** The requirements of sub-chapter 17.3 are applicable to the moulding, casting, inspection and repair procedures of new cast copper alloy propellers, blades and bosses. Subject to a prior agreement with PRS, these requirements may be also applied for the repair and inspection of propellers damaged during service.

**17.3.1.2** Propellers and propeller components shall be cast by foundries approved by PRS in accordance with sub-chapter 1.5, this Part.

**17.3.1.3** Definitions of propeller blade skew angle, severity zones, etc., as well as the requirements concerning repair of propellers are given in *Publication 7/P – Repair of Cast Copper Alloy Propellers*.

### 17.3.2 Moulding and Casting

#### 17.3.2.1 Pouring

The pouring shall be performed into dried moulds using degassed liquid metal. The pouring shall be controlled as to avoid turbulences of flow. Special devices and/or procedures shall be provided to prevent slag and impurities flowing into the mould.

#### 17.3.2.2 Stress Relieving

Subsequent stress relieving heat treatment may be performed to reduce the residual stresses. For this purpose, a specification containing the details of the heat treatment shall be submitted by the manufacturer to PRS for approval. Stress relieving temperatures and holding times are given in *Publication 7/P – Repair of Cast Copper Alloy Propellers*.

### 17.3.3 General Characteristics of Castings

#### 17.3.3.1 Freedom from Defects

Each casting shall have a workmanlike finish and shall be free from defects liable to impair its intended use. Minor casting defects which may still be visible after machining such as small sand and slag inclusions, small cold shuts and scabs shall be trimmed off by the manufacturer (see *Publication 7/P – Repair of Cast Copper Alloy Propellers*).

#### 17.3.3.2 Rectification of Defective Castings

Casting defects which may impair the serviceability of the castings, e.g. major non-metallic inclusions, shrinkage cavities, blow holes and cracks, are not permitted. They shall be removed by one of the methods specified in *Publication 7/P – Repair of Cast Copper Alloy Propellers* and repaired within the limits and restrictions for the severity zones. Full description and documentation of the repairs made shall be presented to PRS Surveyor, on request.

### 17.3.4 Dimensions, Dimensional and Geometrical Tolerances

**17.3.4.1** The dimensions and the dimensional and geometrical tolerances are governed by the data contained in the approved drawings or order documents. These shall be submitted to PRS Surveyor at the time of the tests.

**17.3.4.2** Unless agreed otherwise, the accuracy and verification of the dimensions are the responsibility of the manufacturer.

**17.3.4.3** Static balancing shall be performed on all propellers in accordance with the approved documentation. Dynamic balancing is necessary for propellers running above 500 rpm.

### 17.3.5 Chemical Composition and Structure Characteristics

#### 17.3.5.1 Chemical Composition

Typical copper propeller alloys are grouped into the four types: Cu1, Cu2, Cu3 and Cu4. The chemical composition of typical copper propeller alloys is given in Table 17.3.5.1. Copper alloys, whose chemical composition differs from the values given in Table 17.3.5.1, shall be specially approved by PRS.

**Table 17.3.5.1**  
**Chemical composition of typical cast copper alloys for propellers**

Alloy grade	Chemical composition [%]							
	Cu	Al	Mn	Zn	Fe	Ni	Sn	Pb max.
Cu1 (brass Mn)	52÷62	0.5÷3.0	0.5÷4.0	35÷40	0.5÷2.5	max. 1.0	0.1÷1.5	0.5
Cu2 (brass Mn-Ni)	50÷57	0.5÷2.0	1.0÷4.0	33÷38	0.5÷2.5	3.0÷8.0	max. 0.15	0.5
Cu3 (bronze Ni-Al)	77÷82	7.0÷11.0	0.5÷4.0	max. 1.0	2.0÷6.0	3.0÷6.0	max. 0.1	0.03
Cu4 (bronze Mn-Al)	70÷80	6.5÷9.0	8.0÷20.0	max. 6.0	2.0÷5.0	1.5÷3.0	max. 1.0	0.05

#### 17.3.5.2 Metallurgical Characteristics

The proportion of alpha-phase in Cu1 and Cu2 alloys, determined by the manufacturer on test bars as the average value of five counts, shall be not less than 25 per cent. To ensure adequate ductility and corrosion fatigue resistance, the proportion of beta phase shall be kept low. For this purpose, the zinc equivalent ( $C_{Zn}$ ), determined by formula 17.3.5.2, shall not exceed 45 per cent:

$$C_{Zn} = 100 - \frac{100 \cdot \%Cu}{100 + A} \quad [\%] \quad (17.3.5.2)$$

where:  $A$  – the algebraic sum of the following values:

- 1 · % Sn,
- 5 · % Al,
- 0.5 · % Mn,
- 2.3 · % Ni,
- 0.1 · % Fe.

**Note:** The negative sign in front of the elements Mn, Ni and Fe signifies that these elements tend to reduce the proportion of beta-phase.

The main constituents of the microstructure in the copper-based alloys categories Cu1 and Cu2 are alpha and beta phase. Important properties such as ductility and resistance to corrosion fatigue are strongly influenced by the relative proportion of beta phase (too high a percentage of beta phase has a negative effect on these properties). To ensure adequate ductility and corrosion fatigue resistance, the proportion of beta phase shall be kept low. The concept of the zinc equivalent should be used as control since it summarizes the effect of the tendency of various chemical elements to produce beta phase in the structure.

### 17.3.6 Mechanical Properties

#### 17.3.6.1 Typical Alloys

The mechanical properties of typical cast copper alloys for propellers, determined on test specimens taken from separately cast samples in accordance with Fig. 17.3.6.1, are specified in Table 17.3.6.1.

**Note:** These properties are a measure of the mechanical quality of the metal in each heat, and they are, in generally, not representative of the mechanical properties of the propeller casting itself, which may be up to 30% lower than those of a separately cast test sample.

For integrally cast samples, the mechanical properties shall be subject to special agreement with PRS.

**Table 17.3.6.1**  
**Mechanical properties of typical cast copper alloys for propellers**  
**determined on separately cast test samples**

Alloy grade	$R_{p0.2}$ [MPa] min.	$R_m$ [MPa] min.	$A$ [%] min.
Cu1 (brass Mn)	175	440	20
Cu2 (brass Mn-Ni)	175	440	20
Cu3 (bronze Ni-Al)	245	590	16
Cu4 (bronze Mn-Al)	275	630	18

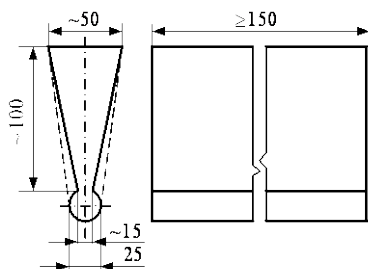

Fig. 17.3.6.1

### 17.3.6.2 Other Alloys

The use of alloys with mechanical properties not meeting the requirements given in Table 17.3.6.1 shall be subject to special agreement with PRS.

### 17.3.7 Testing and Inspection

For cast copper alloys for propellers, the following tests shall be performed. Test specimen dimensions and testing procedures are given in Chapter 2, this Part.

#### 17.3.7.1 Chemical Composition

The manufacturer is obliged to carry out the chemical analysis of each heat.

#### 17.3.7.2 Tensile Test

During tensile test, the tensile strength, 0.2% proof stress and elongation shall be determined. For this purpose, at least one tensile test specimen shall be taken from each test sample.

Generally, test specimens shall be taken from separately cast test samples (see 17.3.6.1). The test sample shall be cast separately in moulds made of the same material as the mould for the propeller and shall be cooled down under the same conditions as the propeller.

If propellers are subjected to heat treatment, the test samples shall be heat treated together with the castings they represent.

Where integrally cast samples are to be used for testing, this will be specially agreed with PRS. Where possible, the test samples shall be taken from the propeller blades in an area lying between 0.5 to 0.6R (where R is the radius of the propeller). The removal of the test sample from the casting shall be performed by non-thermal procedures.

#### 17.3.7.3 Micrographic Examination

The microstructure of alloy types Cu1 and Cu2 shall be verified by determining the proportion of alpha phase. For this purpose, at least one test specimen shall be taken from each heat. The proportion of alpha phase shall be determined as the average value of 5 counts.

#### 17.3.7.4 Surface Quality and Dimensions

Propeller castings shall be visually examined at all stages of manufacture and the whole surface shall be subjected to a comprehensive visual examination in the finished condition by PRS Surveyor. This shall include the bore.

The dimensions shall be checked by the manufacturer and the report on the dimensional inspection shall be handed over to PRS Surveyor. The checks shall be made in the presence of PRS Surveyor.

PRS Surveyor may require areas to be etched (e.g. by iron chloride) for the purpose of investigating weld repairs.

#### 17.3.8 Non-Destructive Tests

##### 17.3.8.1 Penetrant Tests

Blade and boss surfaces of the severity zones A shall be subjected to penetrant tests in the presence of PRS Surveyor. The zone location requirements, inspection and acceptance standards are given in *Publication 7/P – Repair of Cast Copper Alloy Propellers*.

In zones B and C, the penetrant testing shall be performed by the manufacturer. PRS Surveyor may require that the tests should be performed in his presence.

If repairs have been made either by grinding or by welding, the repaired areas shall be subjected to the penetrant tests, irrespective of their severity zone.

##### 17.3.8.2 Radiographic and Ultrasonic Tests

Where there is reason to doubt that the castings are not free from internal defects, PRS Surveyor may require that radiographic and/or ultrasonic tests should be performed. The acceptance criteria, established in accordance with a recognized standard, shall be agreed between the manufacturer and PRS Surveyor.

**Note:** The absorption of the X-rays and gamma-rays is stronger in copper based alloys than in steel. For propeller bronzes and brasses, 300 kV X-rays can normally be used for components up to 50 mm and Co60 gamma-rays up to 160 mm in thickness. Due to the above reasons, radiography is not used for checking the thickest parts of propellers. Also due to the above, ultrasonic testing of Cu1 and Cu2 alloys is not feasible. For Cu3 and Cu4 alloys, ultrasonic testing may be applied.

##### 17.3.8.3 Documentation of Defects and Inspections

All defects requiring welding repair on the castings shall be documented preferably on drawings or special sketches showing their dimensions and locations. Furthermore, the inspection procedure shall be reported. The documentation shall be presented to PRS Surveyor prior to any repair weldings.

##### 17.3.9 Marking

The manufacturer shall adopt a system of identification, which will enable all finished castings to be traced to their original heats. PRS Surveyor shall be given full facilities for so tracing the castings when required.

Castings shall be marked in accordance with the requirements of sub-chapter 1.9, *Part IX*. Additionally, castings shall be marked with the following particulars:

- .1 ice class mark, where applicable,
- .2 propeller blade skew angle (for high-skew propellers).

##### 17.3.10 Inspection Certificate

For each propeller, *Inspection Certificate* is issued by PRS in accordance with the requirements of sub-chapter 1.8, this *Part*. In addition to particulars specified in sub-chapter 1.8, *this Part, Inspection Certificate* shall contain the following information:

- .1 description of the casting with drawing number;
  - .2 diameter, number of blades, pitch, direction of turning;
  - .3 final weight;
  - .4 results of non-destructive tests and details of test procedure, where applicable;
  - .5 portion of alpha-structure for Cu1 and Cu2 alloys;
  - .6 casting identification number;
  - .7 propeller blade skew angle (for high-skew propellers).
-

## 18 ALUMINIUM ALLOYS

### 18.1 Wrought Aluminium Alloys

#### 18.1.1 General Requirements

**18.1.1.1** The requirements of sub-chapter 18.1 are applicable to wrought 5xxx (Al-Mg) and 6xxx (Al-Si-Mg) aluminium alloys intended for use in the construction of hulls, superstructures and other marine structures. They are not applicable to the use of aluminium alloys at low temperature for cryogenic applications.

**18.1.1.2** The requirements of sub-chapter 18.1 are applicable to wrought aluminium alloy products within a thickness range of 3 mm and 50 mm inclusive.

The application of aluminium alloy products outside the above thickness range is subject to special consideration by PRS.

**18.1.1.3** The designation of aluminium alloy temper (delivery heat treatment), defined in the present sub-chapter as “temper condition”, is in accordance with the requirements of PN-EN 515:2017.

**18.1.1.4** PRS may give consent to the use of aluminium alloys not specified in the present Chapter and to alternative temper conditions, subject to a prior agreement with PRS and a detailed study of the alloy properties, including corrosion resistance and of the alloy conditions of use (in particular welding procedures).

#### 18.1.2 Approval of the Manufacturer

All grades of aluminium alloys, including semi-finished products, shall be manufactured at works approved by PRS.

#### 18.1.3 Aluminium Alloys and Their Temper Conditions

Depending on the method of manufacture, the alloy designation and its temper condition shall be as given in Tables 18.1.3-1 and 18.1.3-2.

**Table 18.1.3-1  
Rolled products (sheets, strips and plates)**

Alloy designation		Temper condition <sup>3)</sup>
Grade <sup>1)</sup>	European designation system <sup>2)</sup>	
5083	EN AW-5083 [AlMg4.5Mn0.7]	O, H111, H112, H116, H321
5086	EN AW-5086 [AlMg4]	O, H111, H112, H116
5383	EN AW-5383 [AlMg4.5Mn0.9]	O, H111, H116, H321
5059	-	
5754	EN AW-5754 [AlMg3]	O, H111
5456	-	O, H116, H321

<sup>1)</sup> Designation applied at product marking.  
<sup>2)</sup> Designation according to PN-EN 573-1 and PN-EN 573-2  
<sup>3)</sup> O – annealed, H111 – annealed with slight strain hardening, H112 – slightly strain hardened from working at elevated temperature or from a limited amount of cold work, H116 – strain hardened (for Al-Mg alloys with Mg ≥ 4%, for which limits for mechanical properties and exfoliation corrosion resistance have been specified), H321 – strain hardened and stabilized (¼ hardened).



**Table 18.1.3-2**  
**Extruded products (sections, bars and closed profiles)**

Alloy designation		Temper condition <sup>3)</sup>
Grade <sup>1)</sup>	European designation system <sup>2)</sup>	
5083	EN AW-5083 [AlMg4.5Mn0.7]	O, H111, H112
5086	EN AW-5086 [AlMg4]	
5383	EN AW-5383 [AlMg4.5Mn0.9]	
5059	-	H112
6005A	EN AW-6005A [AlSiMg(A)]	T5, T6
6061	EN AW-6061 [AlMg1SiCu]	T6
6082	EN AW-6082 [AlSi1MgMn]	T5, T6

<sup>1)</sup> Designation applied at product marking  
<sup>2)</sup> Designation according to PN-EN 573-1 and PN-EN 573-2  
<sup>3)</sup> H111 – annealed with slight strain hardening, T5 – cooled from hot working and artificially aged, T6 – solution heat-treated and artificially aged. Other temper conditions as given in Table 18.1.3-1.

**Note:** The alloy grades 6005, 6061 shall not be used in direct contact with sea water unless protected by anodes and/or paint system.

### 18.1.4 Chemical Composition

**18.1.4.1** The manufacturer is obliged to determine the chemical composition of each cast.

**18.1.4.2** The chemical composition of aluminium alloys shall comply with the requirements given in Table 18.1.4.2.

**18.1.4.3** The chemical composition, determined by the manufacturer, will be accepted by PRS subject to occasional checks if required by PRS Surveyor. In particular, product chemical analysis may be required where the final product chemistry is not well represented by the analysis from the cast.

**18.1.4.4** Where the aluminium alloys are not cast in the same works in which they are manufactured into semi-finished products, PRS Surveyor shall be furnished by the works in question with full information on the product, including the reference numbers and chemical composition of each heat.

**Table 18.1.4.2**  
**Chemical composition of wrought aluminium alloys<sup>1)</sup>**

Grade	Si [%]	Fe [%]	Cu [%]	Mn [%]	Mg [%]	Cr [%]	Zn [%]	Ti [%]	Other elements <sup>2)</sup> each [%]	Other elements <sup>2)</sup> total [%]
5083	0.40	0.40	0.10	0.4÷1.0	4.0÷4.9	0.05÷0.25	0.25	0.15	0.05	0.15
5383	0.25	0.25	0.20	0.7÷1.0	4.0÷5.2	0.25	0.4	0.15	0.05 <sup>5)</sup>	0.15 <sup>5)</sup>
5059	0.45	0.50	0.25	0.6÷1.2	5.0÷6.0	0.25	0.4÷0.9	0.20	0.05 <sup>6)</sup>	0.15 <sup>6)</sup>
5086	0.40	0.50	0.10	0.2÷0.7	3.5÷4.5	0.05÷0.25	0.25	0.15	0.05	0.15
5754	0.40	0.40	0.10	0.50 <sup>3)</sup>	2.6÷3.6	0.3 <sup>3)</sup>	0.20	0.15	0.05	0.15
5456	0.25	0.40	0.10	0.5÷1.0	4.7÷5.5	0.05÷0.20	0.25	0.20	0.05	0.15
6005A	0.5÷0.9	0.35	0.30	0.50 <sup>4)</sup>	0.4÷0.7	0.30 <sup>4)</sup>	0.20	0.10	0.05	0.15
6061	0.4÷0.8	0.70	0.15÷0.4	0.15	0.8÷1.2	0.04÷0.35	0.25	0.15	0.05	0.15
6082	0.7÷1.3	0.50	0.10	0.4÷1.0	0.6÷1.2	0.25	0.20	0.10	0.05	0.15

- <sup>1)</sup> Composition in percentage mass by mass maximum unless shown as a range.  
<sup>2)</sup> Includes Ni, Ga, V and listed elements for which no specific limit is shown.  
<sup>3)</sup> Mn + Cr : 0.10 ÷ 0.60.  
<sup>4)</sup> Mn + Cr : 0.12 ÷ 0.50.  
<sup>5)</sup> Zr<sub>max</sub> = 0,20%. The total for other elements does not include zirconium.  
<sup>6)</sup> Zr = 0.05 ÷ 0.25%. The total for other elements does not include zirconium.

### 18.1.5 Mechanical Properties

**18.1.5.1** The mechanical properties of aluminium alloys, depending on temper condition, shall comply with the requirements given in Tables 18.1.5.1-1 and 18.1.5.1-2.

**Note:** Regard shall be paid to the fact that the mechanical properties of the welded joints are lower for strain hardened or heat treated alloys, when compared with those of the parent material.

**Table 18.1.5-1**  
**Mechanical properties for rolled products with a thickness of  $3 \leq t \leq 50$  mm<sup>3)</sup>**

Grade	Temper condition	Thickness $t$ [mm]	$R_{p0.2}$ [MPa] min. or range	$R_m$ [MPa] min. or range	A [%] min. <sup>1,3)</sup>	
					$A_{50\text{ mm}}$	A
5083	O	$3 \leq t \leq 50$	125	275 ÷ 350	16	14
	H111	$3 \leq t \leq 50$	125	275 ÷ 350	16	14
	H112	$3 \leq t \leq 50$	125	275	12	10
	H116	$3 \leq t \leq 50$	215	305	10	10
	H321	$3 \leq t \leq 50$	215 ÷ 295	305 ÷ 385	12	10
5383	O	$3 \leq t \leq 50$	145	290		17
	H111	$3 \leq t \leq 50$	145	290		17
	H116	$3 \leq t \leq 50$	220	305	10	10
	H321	$3 \leq t \leq 50$	220	305	10	10
5059	O	$3 \leq t \leq 50$	160	330	24	24
	H111	$3 \leq t \leq 50$	160	330	24	24
	H116	$3 \leq t \leq 20$	270	370	10	10
		$20 < t \leq 50$	260	360		10
	H321	$3 \leq t \leq 20$	270	370	10	10
		$20 < t \leq 50$	260	360		10
5086	O	$3 \leq t \leq 50$	95	240 ÷ 305	16	14
	H111	$3 \leq t \leq 50$	95	240 ÷ 305	16	14
	H112	$3 \leq t \leq 12.5$	125	250	8	
		$12.5 < t \leq 50$	105	240		9
	H116	$3 \leq t \leq 50$	195	275	10 <sup>2)</sup>	9
5754	O	$3 \leq t \leq 50$	80	190 ÷ 240	18	17
	H111	$3 \leq t \leq 50$	80	190 ÷ 240	18	17
5456	O	$3 \leq t \leq 6.3$	130 ÷ 205	290 ÷ 365	16	
		$6.3 < t \leq 50$	125 ÷ 205	285 ÷ 360	16	14
	H116	$3 \leq t \leq 30$	230	315	10	10
		$30 < t \leq 40$	215	305		10
		$40 < t \leq 50$	200	285		10
	H321	$3 \leq t \leq 12.5$	230 ÷ 315	315 ÷ 405	12	
		$12.5 < t \leq 40$	215 ÷ 305	305 ÷ 385		10
		$40 < t \leq 50$	200 ÷ 295	285 ÷ 370		10

<sup>1)</sup> Elongation  $A_{50\text{ mm}}$  applies for thickness  $\leq 12.5$  mm, and A for thickness over 12.5 mm.

<sup>2)</sup> 8% for thickness up to and including 6.3 mm.

<sup>3)</sup> The values are applicable for both longitudinal and transverse test specimens.

**Note:**

Although the mechanical properties of O and H111 tempers are the same, they represent different processing and dual grade designation (i.e. O/H111) shall not be used.

**Table 18.1.5-2**  
**Mechanical properties of extruded open profiles with a thickness of  $3 \leq t \leq 50 \text{ mm}^2$**

Grade	Temper condition	Thickness $t$ [mm]	$R_{p0.2}$ [MPa] min.	$R_m$ [MPa] min. or range	$A$ [%] min. <sup>1,2)</sup>	
					$A_{50 \text{ mm}}$	$A$
5083	0	$3 \leq t \leq 50$	110	270-350	14	12
	H111	$3 \leq t \leq 50$	165	275	12	10
	H112	$3 \leq t \leq 50$	110	270	12	10
5383	0	$3 \leq t \leq 50$	145	290	17	17
	H111	$3 \leq t \leq 50$	145	290	17	17
	H112	$3 \leq t \leq 50$	190	310		13
5059	H112	$3 \leq t \leq 50$	200	330		10
5086	0	$3 \leq t \leq 50$	95	240 ÷ 315	14	12
	H111	$3 \leq t \leq 50$	145	250	12	10
	H112	$3 \leq t \leq 50$	95	240	12	10
6005A	T5	$3 \leq t \leq 50$	215	260	9	8
		$3 \leq t \leq 10$	215	260	8	6
	T6	$10 < t \leq 50$	200	250	8	6
6061	T6	$3 \leq t \leq 50$	240	260	10	8
6082	T5	$3 \leq t \leq 50$	230	270	8	6
		$3 \leq t \leq 5$	250	290	6	
	T6	$5 < t \leq 50$	260	310	10	8

<sup>1)</sup> Elongation  $A_{50 \text{ mm}}$  applies for thickness  $\leq 12.5 \text{ mm}$  and  $A$  for thickness over 12.5 mm.  
<sup>2)</sup> The values are applicable for both longitudinal and transverse tensile test specimens.

### 18.1.6 Freedom from Defects

**18.1.6.1** The finished material shall have a workmanlike finish and shall be free from internal and surface defects detrimental to its intended application.

**18.1.6.2** Slight surface imperfections within dimensional tolerances may be removed by grinding or machining.

### 18.1.7 Dimensional Tolerances

**18.1.7.1** The underthickness tolerances of products cannot exceed the values given in Table 18.1.7.1.

**Table 18.1.7.1**  
**Underthickness tolerances for rolled products**

Nominal thickness $t$ [mm]	Thickness tolerances for nominal width [mm]		
	up to 1500	from 1500 to 2000	from 2000 to 3500
$3 \leq t < 4$	0.10	0.15	0.15
$4 \leq t < 8$	0.20	0.20	0.25
$8 \leq t < 12$	0.25	0.25	0.25
$12 \leq t < 20$	0.35	0.40	0.50
$20 \leq t < 50$	0.45	0.50	0.65

**18.1.7.2** Dimensional tolerances other than those given in Table 18.1.7.1 shall be specially agreed with PRS.

## 18.1.8 Testing and Inspection

### 18.1.8.1 Testing Procedures

The shape and dimensions of test specimens and testing procedures shall be in accordance with the requirements of Chapter 2, this *Part*.

### 18.1.8.2 Non-Destructive Tests

Non-destructive testing of materials is not required. However, the manufacturer is expected to employ suitable methods of non-destructive testing for the general maintenance of quality standards.

### 18.1.8.3 Dimensions

It is the manufacturer's responsibility to check the materials for compliance with the requirements specified in 18.1.7.

### 18.1.8.4 Verification of Proper Fusion of Press Welds for Closed Profiles

For each batch of closed profiles, the manufacturer shall demonstrate, by conducting macrosection test or drift expansion test that there is no lack of fusion at the press welds. The drift expansion test shall be performed in accordance with the below requirements:

- .1 every fifth profile shall be tested after the final heat treatment. From batches of five profiles or less, one profile shall be tested. Where the length of profiles exceeds 6 m, every profile shall be tested. The number of tests may be reduced to every fifth profile if the results from the first 3÷5 profiles are found acceptable;
- .2 from each profile subjected to tests, two test specimens, cut from the front and back end of the profile, shall be taken;
- .3 the test specimens shall be cut with the ends perpendicular to the axis of the profile. The edges of the end may be rounded by filing;
- .4 the length of the test specimen shall comply with the requirements specified in Chapter 2, this *Part*;
- .5 testing shall be performed at ambient temperature and shall consist in expanding the end of the profile by means of hardened conical steel former having an included angle of at least 60°;
- .6 the test specimen is considered to be unacceptable if clean split along the weld which confirms lack of fusion has been stated.

### 18.1.8.5 Corrosion Testing

**18.1.8.5.1** Wrought aluminium alloys of grades 5083, 5383, 5059, 5086 and 5456 in the H116 and H321 temper conditions intended for use in marine hull construction or in marine applications where frequent direct contact with sea water is expected shall be corrosion tested with respect to exfoliation and intergranular corrosion resistance.

**18.1.8.5.2** The manufacturer shall establish the relationship between microstructure and resistance to corrosion for the above listed alloys. Reference photomicrographs taken at 500x, under the conditions specified in ASTM B928:2015, Section 9.4.1, shall be established for each temper condition and thickness ranges. The photographs shall be taken from test samples which have exhibited no evidence of exfoliation corrosion and a pitting rating of PB or better, when subjected to the test described in ASTM G66:2018 (ASSET). The test specimens shall also exhibit resistance to intergranular corrosion at a mass loss not greater than 15 mg/cm<sup>2</sup>, when subjected to the test described in ASTM G67:2018 (NAMLT). Upon satisfactory establishment of the relationship between microstructure and resistance to corrosion, the reference photomicrographs and the results of the corrosion tests shall be submitted to PRS for approval. Production practises shall not be changed after approval of the reference micrographs.

Other test methods may also be accepted subject to agreement with PRS.

**18.1.8.5.3** For batch acceptance of 5xxx-alloys listed in 18.1.8.5.1, metallographic examination of one test sample selected from mid width at one end of a coil, plate or section, taken at random, shall be performed. The microstructure of the test sample shall be compared with the reference photomicrographs of the accepted material in the presence of PRS surveyor. A longitudinal section perpendicular to the rolled surface shall be prepared for metallographic examination, under the conditions specified in ASTM B928:2015, Section 9.6.1. If the microstructure shows evidence of continuous grain boundary network of Al-Mg precipitate in excess of the reference photomicrographs of accepted material, the batch is either to be rejected or tested in respect to exfoliation and intergranular corrosion resistance subject to the agreement of the PRS surveyor. The corrosion tests shall be in accordance with ASTM G66:2018 and ASTM G67:2018 or equivalent standards. The sample shall exhibit no evidence of exfoliation corrosion and a pitting rating of PB or better when subjected to the test described in ASTM G66. The sample shall exhibit resistance to intergranular corrosion at a mass loss no greater than 15 mg/cm<sup>2</sup> when subjected to the test described in ASTM G67:2018. If the results from testing satisfy the acceptance criteria stated above, the batch is accepted, else it shall be rejected.

**18.1.8.5.4** As an alternative to metallographic examination, each batch may be tested for exfoliation corrosion resistance and intergranular corrosion resistance, in accordance with ASTM G66 and G67 under the conditions specified in ASTM B928:2015, or equivalent standards. If this alternative is used, then the results of the test must satisfy the acceptance criteria stated in 18.1.8.5.3.

## **18.1.9 Test Materials**

### **18.1.9.1 Definition of a Batch**

A batch consists of products:

- of the same alloy grade and from the same cast,
- of the same product form and similar dimensions (in the case of plates – the same thickness),
- manufactured by the same process,
- having been submitted simultaneously to the same temper condition.

### **18.1.9.2 Location of Test Specimens**

Test specimens shall be taken as follows:

- at one third of the width from a longitudinal edge of rolled products;
- in the range 1/3 to 1/2 of the distance from the edge to the centre of the thickest part of extruded products.

### **18.1.9.3 Orientation of Test Specimens**

#### **.1 Rolled products**

In general, transverse test specimens are required. If the product width is insufficient to provide transverse specimens or in the case of strain hardening alloys, longitudinal test specimens will be permitted.

#### **.2 Extruded products**

From extruded products, longitudinal test specimens shall be taken.

**18.1.9.4** After cutting test specimens from the product, each test specimen shall be clearly marked, having regard to its location and orientation.

## **18.1.10 Tensile Test Specimens**

**18.1.10.1** The type and location of tensile test specimens shall be in accordance with the requirements of Chapter 2, this *Part*.



### 18.1.11 Number of Test Specimens

#### 18.1.11.1 Number of Tensile Test Specimens

##### .1 *Rolled products*

One tensile test specimen shall be taken from each batch of the product. If the weight of one batch exceeds 2000 kg, one extra tensile test specimen shall be taken from every 2000 kg of the product or fraction thereof, in each batch. For single plates or for coils weighing more than 2000 kg each, only one tensile test specimen per plate or coil shall be taken.

##### .2 *Extruded products*

For the products with a nominal weight of less than 1 kg/m, one tensile test specimen shall be taken from each 1000 kg, or fraction thereof, in each batch.

For nominal weights between 1 and 5 kg/m, one tensile test specimen shall be taken from each 2000 kg or fraction hereof, in each batch.

If the nominal weight exceeds 5 kg/m, one tensile test specimen shall be taken for each 3000 kg of the product or fraction thereof, in each batch.

#### 18.1.11.2 Verification of Proper Fusion of Press Welds

For closed profiles, verification of proper fusion of press welds shall be performed on each batch in accordance with the requirements of paragraph 18.1.8.4.

#### 18.1.11.3 Corrosion Tests

For rolled products of grades 5083, 5383, 5059, 5086 and 5456 delivered in the tempers H116 or H321 temper conditions, one test sample shall be tested per batch.

#### 18.1.12 Re-tests

**18.1.12.1** When the tensile test on the first test sample selected in accordance with 18.1.11 fails to meet the requirements of the Rules, two further tests of the same test sample shall be performed. If both of these additional tests comply with the requirements of the Rules, this test sample and the remaining test samples from the same batch may be accepted.

**18.1.12.2** If one or both additional tests do not comply with the requirements of the Rules, the test sample shall be rejected, but the remaining material from the same batch may be accepted, provided that two of the remaining test pieces in the batch selected in the same way, are tested with satisfactory results. If unsatisfactory results are obtained from either of these two test pieces then the batch of material shall be rejected.

**18.1.12.3** In the event of any material bearing PRS mark failing to comply with the requirements of the *Rules*, the mark shall be removed by the manufacturer.

#### 18.1.13 Marking

**18.1.13.1** The manufacturer shall adopt a system of identification, which will enable all aluminium alloy products to be traced back to the original ladle of metal. PRS Surveyor shall be given full facilities for so tracing the products when required.

**18.1.13.2** The products shall be marked in accordance with the requirements of sub-chapter 1.9, this Part. Additionally, the products subjected to corrosion testing in accordance with 18.1.8.5 shall be marked with the letter “M”, put after the temper condition designation, e.g. 5083 H321 M.

### 18.1.14 Inspection Certificate

For each accepted batch of aluminium alloy products, *Inspection Certificate* is issued by PRS in accordance with the requirements of sub-chapter 1.8, this *Part*.

## 18.2 Aluminium Alloy Castings

### 18.2.1 General Requirements

**18.2.1.1** The requirements of sub-chapter 18.2 apply to parts and structures of aluminium alloy castings used in hull structure or ship machinery subject to PRS survey.

**18.2.1.2** Castings shall be made at manufacturers approved by PRS and according to manufacturing process agreed with PRS.

**18.2.1.3** All castings shall be free from internal defects which would be prejudicial to their proper application in service. The surface finish shall be in accordance with good practice and requirements specified in the approved quality plan.

**18.2.1.4** The designation of aluminium alloy temper (delivery heat treatment) defined in the present sub-chapter as “temper condition” shall be in accordance with PN-EN 515.

### 18.2.2 Chemical Composition and Mechanical Properties

**18.2.2.1** The chemical composition and mechanical properties of aluminium alloy castings shall comply with the requirements of Table 18.2.2.1.

**18.2.2.2** The values of mechanical properties, given in Table 18.2.2.1, apply to sand castings. When metal mould or pressure casting is used, higher values of mechanical properties may be required by PRS. In this case, the required mechanical properties and sampling procedure shall be agreed with PRS.

**18.2.2.3** The use of alloys with chemical composition and mechanical properties differing from those given in Table 18.2.2.1 shall be specially agreed with PRS. For alloys having a modified chemical composition, PRS may require a check of corrosion resistance to be made.

**Table 18.2.2.1**  
**Chemical composition and mechanical properties of aluminium alloy castings**

Grade (European designation system)	Chemical composition <sup>1)</sup> (basic elements) [%]	Temper condition <sup>2)</sup>	Mechanical properties <sup>3)</sup>			
			$R_{p0,2}$ [MPa] min.	$R_m$ [MPa] min.	$A$ [%] min.	$HB$ (approx. values)
AlMg5(Si) (EN AC- 51400)	Mg = 4.5-6.5 Si ≤ 1.5 Mn ≤ 0.45 Al the remainder	F	100	160	3	60
AlMg9 (EN AC- 51200)	Mg = 8-10,5 Si ≤ 2.5 Fe ≤ 1 Al the remainder	T4	170	280	8	70
AlSi9Mg (EN AC-43300)	Si = 9-10 Mg = 0.25-0.45 Mn ≤ 0,1 Al the remainder	F	90	170	2	55
		T6	190	230	2	75
AlSi11 (EN AC-44000)	Si = 10-11.8 Mg ≤ 0.45 Mn ≤ 0.1 Al the remainder	F	70	150	6	45
		T6	–	180	6	50

**Notes:**

- 1) The permissible content of impurities shall be taken according to recognized standards, e.g. PN-EN 1706.
- 2) F – as manufactured, T4 – solution heat-treated and naturally aged, T6 – solution heat-treated and artificially aged.
- 3) Mechanical properties determined on separately cast specimens.

**18.2.3 Temper Condition**

**18.2.3.1** If aluminium alloy castings shall be heat treated, the type of heat treatment shall be determined by the manufacturer and recorded in *Inspection Certificate*.

**18.2.3.2** Temper conditions for aluminium alloy castings are given in Table 18.2.2.1.

**18.2.4 Tests**

**18.2.4.1** The type and scope of tests of aluminium alloy castings shall be determined according to Table 18.2.4.1.

Test samples may be cast directly on castings or may be cast separately.

**Table 18.2.4.1  
Scope of tests for aluminium alloy castings**

Test group	Intended application	Examples of application	Type of tests	Scope of tests	
				Batch size	Number of tests
I	Castings subject to loads and exposed to corrosion	Parts of internal combustion engines, pumps, compressors, fans, valves	Determination of chemical composition	per cast	
			Tensile test	1 cast	2
II	Parts operating at high temperature and exposed to lubricating and fuel oils, etc.	Pistons of internal combustion engines, compressors	Determination of chemical composition	per cast	
			Tensile test	1 cast	1
			Hardness test	each product	1

**18.2.4.2** The sample thickness shall not be less than the minimum wall thickness of the casting. Where possible, the cooling of the samples shall be done in conditions similar to the cooling of castings. In the case of castings for parts operating under high loads, the thickness of the samples shall not be less than the thickness of the highest loaded wall of the part and shall be indicated in the drawing.

Where samples shall be taken directly from cast, the scope of the tests shall be agreed with PRS.

**18.2.4.3** Tensile tests shall be conducted to determine proof stress, tensile strength and elongation. Subject to agreement with PRS, the yield stress determination may be omitted. Where castings for small-size pistons are tested, PRS may also omit the tensile test and be satisfied with hardness determination.

**18.2.5 Inspection of Surface and Work Quality**

Castings shall be submitted for inspection in cleaned condition, with gating system, heads and burrs removed. The surfaces shall not be hammered or treated in any way which may obscure defects.

Before acceptance, all castings shall be visually examined by PRS Surveyor. Where practicable, the visual examination shall include inspection of internal surfaces. Unless agreed otherwise, the verification of dimensions is the responsibility of the manufacturer.

Castings to be used for the manufacture of items operating at high loads shall be subjected, at the request of PRS Surveyor, to non-destructive tests.



Where required by the *Rules*, castings shall be pressure tested before the final acceptance. These tests shall be performed in the presence of PRS Surveyor. The casting drawing shall contain information of the working pressure in the tested cavity and the test pressure.

In the event of any casting proving defective during subsequent machining or testing, it shall be rejected notwithstanding the preceding acceptance procedure.

## **18.2.6 Repair of Defective Castings**

### **18.2.6.1 General Requirements**

The procedure of defective castings repair shall be agreed with PRS. The procedure of defect removal and weld repair shall be in accordance with Chapter 23, this *Part*. The defects shall be removed in such a way as to enable the proper welding procedure to be used. The resulting grooves shall be subsequently ground smooth after complete elimination of the defective material and verified by non-destructive tests.

The manufacturer shall maintain full records of repairs and subsequent non-destructive tests traceable to each repaired casting. These records shall be available to PRS Surveyor, on request.

### **18.2.6.2 Weld Repairs**

If it has been agreed between the manufacturer and PRS that a casting can be repaired by welding, the requirements specified in Chapter 23, this *Part* shall be complied with.

The welding procedure shall be tested by the manufacturer to demonstrate that satisfactory mechanical properties can be obtained after heat treatment specified in 18.2.3.

## **18.2.7 Marking**

**18.2.7.1** The manufacturer shall adopt a system of identification, which will enable all finished castings to be traced to the original ladle of metal. PRS Surveyor shall be given full facilities for so tracing the castings when required.

**18.2.7.2** Castings shall be marked in accordance with the requirements of sub-chapter 1.9, this *Part*.

**18.2.7.3** Where small castings are manufactured in large numbers, modified arrangements for identification shall be specially agreed with PRS.

## **18.2.8 Inspection Certificate**

For accepted aluminium alloy castings, *Inspection Certificate* is issued by PRS in accordance with the requirements of sub-chapter 1.8, this *Part*. In addition to particulars specified in sub-chapter 1.8, this *Part*, *Inspection Certificate* shall contain the following information:

- .1 non-destructive tests results, where applicable,
- .2 details of heat treatment, including temperatures and holding times,
- .3 pressure test results, where applicable.

## 19 REQUIREMENTS FOR MANUFACTURE OF ANCHORS

### 19.1 General Requirements

#### 19.1.1 Application

**19.1.1.1** The requirements of the present Chapter apply to materials, manufacture, tests and acceptance of anchors, shanks and anchor shackles produced from cast or forged steel, or fabricated by welded rolled steel plates and bars.

**19.1.1.2** Any changes to the design and manufacturing process shall be agreed with PRS.

#### 19.1.2 Anchor Types

With regard to holding power at sea, the types of anchors covered include (refer to *Part III – Hull Equipment*):

- .1 ordinary anchors:
  - stockless Hall anchor,
  - Admiralty type anchor,
- .2 high holding power (HHP) anchors;
- .3 super high holding power (SHHP) anchors.

### 19.2 Materials

#### 19.2.1 Materials for Anchors

Anchors shall be manufactured from materials meeting the requirements of the present Part of the *Rules*, as indicated below:

- .1 cast steel anchor flukes, shanks, swivels and shackles shall be manufactured and tested in accordance with the requirements specified in Chapter 13, this *Part* and comply with the requirements for castings of welded construction. The steel shall be fine grain treated with aluminium. The use of other grades of steels for the manufacture of swivels shall be specially agreed with PRS;
- .2 forged steel anchor pins, shanks, swivels and shackles shall be manufactured and tested in accordance with the requirements specified in Chapter 12, this *Part*. Shanks, swivels and shackles shall comply with the requirements for carbon and carbon-manganese steels for welded construction. The use of other grades of steels for the manufacture of swivels shall be specially agreed with PRS;
- .3 rolled billets, plates and bars for anchors fabrication shall be manufactured and tested in accordance with the requirements specified in Chapter 3, this *Part*;
- .4 rolled bars intended for pins, swivels and shackles shall be manufactured and tested in accordance with the requirements specified in Chapter 3, this *Part*.

#### 19.2.2 Materials for Super High Holding Power (SHHP) Anchors

**19.2.2.1** In addition to the requirements specified in sub-chapter 19.2.1, SHHP anchors shall be produced in accordance with the material toughness requirements specified below.

**19.2.2.2** The base steel grades in welded SHHP anchors shall be selected in accordance with the requirements specified in Part II – Hull for hull members of class II. The welding consumables shall satisfy the toughness for the base steel grades in accordance with the requirements specified in Chapter 24, this Part. The toughness of the anchor shackles for SHHP anchors shall meet that for grade 3 anchor chain in accordance with the requirements specified in Chapter 20, this Part. The toughness of steel castings for SHHP anchors shall be not less than a Charpy V-notch energy average of 27 J at the temperature of 0°C.

## 19.3 Manufacture of Anchors

### 19.3.1 Tolerance

**19.3.1.1** The clearance on either side of the shank within the shackle jaws shall be not more than 3 mm for small anchors up to 3 tonnes weight, 4 mm for anchors up to 5 tonnes weight, 6 mm for anchors up to 7 tonnes weight and shall not exceed 12 mm for larger anchors.

**19.3.1.2** The shackle pin shall be a push fit in the eyes of the shackle, which shall be chamfered on the outside to ensure good tightness when the pin is clenched over on fitting. The shackle pin to hole tolerance shall be not more than 0.5 mm for pins up to 57 mm and 1.0 mm for pins of larger diameter.

**19.3.1.3** The lateral movement of the shank shall not exceed 3 degrees (Fig. 19.3.1.3).

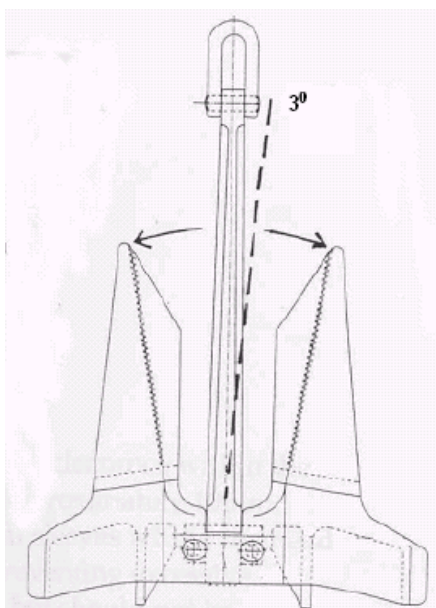

Fig. 19.3.1.3. Allowable lateral movement of shank

### 19.3.2 Welding of Anchors

Welded construction of fabricated anchors shall be made in accordance with the welding procedure specification approved by PRS. Welding shall be performed by the manufacturer approved by PRS. Welders shall hold valid PRS qualification test certificates; the welding consumables used shall be approved by PRS. Non-destructive tests shall be performed in accordance with the requirements specified in sub-chapter 19.4.2.

### 19.3.3 Heat Treatment

**19.3.3.1** Components for cast or forged anchors shall be properly heat treated, i.e. fully annealed, normalized or normalized and tempered in accordance with the requirements specified in Chapters 12 and 13, this *Part*.

**19.3.3.2** Fabricated anchors may require stress relieving after welding depending on the weld thickness. Stress relieving shall be performed as indicated in the approved welding procedure specification. Stress relieving temperatures shall not exceed the tempering temperature of the parent material.

### 19.3.4 Freedom from Defects

All parts shall have a clean surface and be free from cracks, notches, inclusions and other defects that would impair the performance of the product.

### 19.3.5 Repairs

Any necessary repairs to forged and cast anchors shall be accepted by PRS Surveyor and performed in accordance with the repair criteria indicated in Chapters 12 and 13, this *Part*. Repairs to fabricated anchors shall be accepted by PRS Surveyor and shall be performed in accordance with welding procedure specification agreed with PRS, following the parameters of the welding procedures used in construction.

### 19.3.6 Anchor Assembly

Anchor assembly and fitting shall be made in accordance with the design details. Securing of the anchor pin, shackle pin or swivel nut by welding shall be made in accordance with the agreed procedure.

## 19.4 Testing and Certification

### 19.4.1 Proof Load Test

Proof load tests shall be performed by an approved testing facility. Proof load testing for anchors shall be performed in accordance with the requirements specified below considering the anchor type.

#### 19.4.1.1 Testing of Ordinary Anchors

- .1 The proof load, as per Table 19.4.1.1, shall be applied on the arm or on the palm at a spot which, measured from the extremity of the bill, is one-third of the distance between the bill and the centre of the crown as shown in Figs. 19.4.1.1-1 and 19.4.1.1-2.

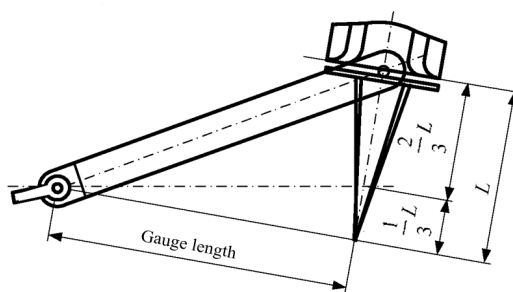

Fig. 19.4.1.1-1. Stockless Hall anchor

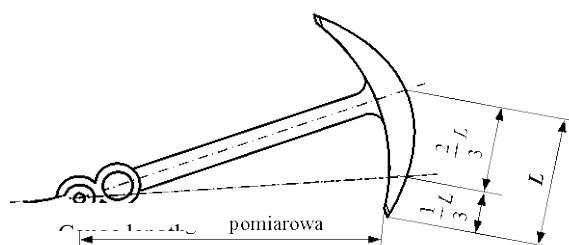

Fig. 19.4.1.1-2. Admiralty type anchor

In the case of stockless anchors, both arms shall be tested at the same time, first on one side of the shank, then reversed and tested on the other.

- .2 Anchors of all sizes shall be proof load tested with the test loads specified in Table 19.4.1.1.

3 Before application of proof test load, the cast anchors shall be carefully examined to be sure that castings are reasonably free of surface imperfections of harmful nature. After proof load testing, the anchors shall be examined for cracks and other defects. Additionally, stockless

anchors shall be examined for rotation of their heads over the complete angle  $\left(45^{+3^{\circ}}_{-1^{\circ}}\right)$ . In every test, the difference between the gauge lengths (see Figs. 19.4.1.1-1 and 19.4.1.1-2) where one-tenth of the required load was applied first and where the load has been reduced to one-tenth of the required load from the full load shall not exceed 1%.

**Table 19.4.1.1**  
**Proof load tests for anchors**

Mass of anchor [kg]	Proof test load [kN]	Mass of anchor [kg]	Proof test load [kN]	Mass of anchor [kg]	Proof test load [kN]	Mass of anchor [kg]	Proof test load [kN]
50	23.2	1250	239	5000	661	12500	1130
55	25.2	1300	247	5100	669	13000	1160
60	27.1	1350	255	5200	677	13500	1180
65	28.9	1400	262	5300	685	14000	1210
70	30.7	1450	270	5400	691	14500	1230
75	32.4	1500	278	5500	699	15000	1260
80	33.9	1600	292	5600	706	15500	1270
90	36.3	1700	307	5700	713	16000	1300
100	39.1	1800	321	5800	721	16500	1330
120	44.3	1900	335	5900	728	17000	1360
140	49.0	2000	349	6000	735	17500	1390
160	53.3	2100	362	6100	740	18000	1410
180	57.4	2200	376	6200	747	18500	1440
200	61.3	2300	388	6300	754	19000	1470
225	65.8	2400	401	6400	760	19500	1490
250	70.4	2500	414	6500	767	20000	1520
275	74.9	2600	427	6600	773	21000	1570
300	79.5	2700	438	6700	779	22000	1620
325	84.1	2800	450	6800	786	23000	1670
350	88.8	2900	462	6900	794	24000	1720
375	93.4	3000	474	7000	804	25000	1770
400	97.9	3100	484	7200	818	26000	1800
425	103	3200	495	7400	832	27000	1850
450	107	3300	506	7600	845	28000	1900
475	112	3400	517	7800	861	29000	1940
500	116	3500	528	8000	877	30000	1990
550	124	3600	537	8200	892	31000	2030
600	132	3700	547	8400	908	32000	2070
650	140	3800	557	8600	922	34000	2160
700	149	3900	567	8800	936	36000	2250
750	158	4000	577	9000	949	38000	2330
800	166	4100	586	9200	961	40000	2410
850	175	4200	595	9400	975	42000	2490
900	182	4300	604	9600	987	44000	2570
950	191	4400	613	9800	998	46000	2650
1000	199	4500	622	10000	1010	48000	2730
1050	208	4600	631	10500	1040		
1100	216	4700	638	11000	1070		
1150	224	4800	645	11500	1090		
1200	231	4900	653	12000	1110		

Proof loads for intermediate mass shall be determined by linear interpolation.

**19.4.1.2 Testing of High Holding Power (HHP) Anchors**

The HHP anchor shall be proof load tested with the load required by Table 19.4.1.1 for an anchor mass increased by 33%, i.e. equal to 1.33 times the actual mass of the HHP anchor. The proof load test procedure and examination procedure for HHP anchors shall comply with those for ordinary anchors specified in sub-chapter 19.4.1.1.

**19.4.1.3 Testing of Super High Holding Power (SHHP) Anchors****.1 Anchor proof load test**

The SHHP anchor shall be proof load tested with the load required by Table 19.4.1.1 for an anchor mass increased by 100%, i.e. equal to 2 times the actual mass of the SHHP anchor. The proof load test procedure and examination procedure for SHHP anchors shall comply with those for ordinary anchors.

**.2 Anchor inspections and additional tests**

After the proof load test, all SHHP anchors shall be surface inspected by the dye penetrant method or by the magnetic particle method.

All surfaces of cast anchors shall be surface inspected. The criteria for assessment of the casting surface defects shall be specially agreed with PRS in each particular case.

Each cast anchor shall be examined by ultrasonic tests in way of areas where feeder heads and risers have been removed and where weld repairs have been performed. Ultrasonic tests and the criteria for assessment of defects shall be specially agreed with PRS. Welded anchors shall be inspected at the welds.

In justified cases, at sections of high load or at suspect areas, PRS may require volumetric non-destructive examination; e.g. ultrasonic test or radiographic test to be performed.

PRS Surveyor may require additional tests of the anchor, e.g. the hammering test and the drop test of cast anchors to be performed.

**19.4.2 Product Tests****19.4.2.1 Product Test Programmes**

PRS may request that either programme A or programme B shall be applied.

**Table 19.4.2.1-1**  
**Applicable programmes for each product form**

Item	Product test	Product form		
		Cast components	Forged components	Fabricated/welded components
1	Programme A	Applicable	Not applicable	Not applicable
2	Programme B	Applicable <sup>1)</sup>	Applicable	Applicable

<sup>1)</sup> Charpy V-notch impact tests shall be performed to demonstrate at least 27 J average at 0°C.

**Table 19.4.2.1-2**  
**Product test requirements for programmes A and B**

Programme A	Programme B
Drop test	–
Hammering test	–
Visual inspection	Visual inspection
General non-destructive tests	General non-destructive tests
–	Extended non-destructive tests

**19.4.2.2** The scope of general and extended non-destructive tests, depending on the anchor type, is given in Tables 19.4.2.5-1, 19.4.2.5-2 and 19.4.2.6.

**19.4.2.3 Drop Test**

Each anchor component (fluke and shank) is individually raised to a height of 4 m and dropped on to a steel slab. The steel slab shall be suitable to resist the impact of the dropped component.

**19.4.2.4 Hammering Test**

After the drop test, hammering tests are performed on each anchor component (fluke and shank) which is slung clear of the ground, using a non-metallic sling, and hammered to check the soundness of the component. A hammer of at least 3 kg mass shall be used.

**19.4.2.5 Visual Examination**

After the proof load test, visual examination of all accessible surfaces shall be performed. Inspected components shall be free from cracks.

**19.4.2.6 General Non-destructive Tests**

After the proof load test, general non-destructive tests shall be performed as indicated in Tables 19.4.2.5-1 and 19.4.2.5-2.

**Table 19.4.2.5-1**  
**Scope of general NDT for ordinary and high holding power (HHP) anchors**

Item	Location	NDT method
1	Castings	PT or MT
2	Weld repairs	PT or MT
3	Forged components	Not applicable
4	Fabrication welds	PT or MT

**Table 19.4.2.5-2**  
**Scope of general NDT for SHHP anchors**

Item	Location	NDT method
1	Castings	PT or MT and UT
2	All surfaces of castings	PT or MT
3	Weld repairs	PT or MT
4	Forged components	Not applicable
5	Fabrication welds	PT or MT

**19.4.2.7 Extended Non-destructive Tests**

After the drop test, extended NDT shall be performed as specified in Table 19.4.2.6.

**Table 19.4.2.6**  
**Extended NDT for ordinary, high holding power (HHP) and super high holding power (SHHP) anchors**

Item	Location	NDT method
1	Castings	PT or MT and UT
2	All surfaces of castings	PT or MT
3	Random areas of castings	UT
4	Weld repairs	PT or MT
5	Forged components	Not applicable
6	Fabrication welds	PT or MT

### 19.4.2.8 Repair criteria

If defects are detected by non-destructive tests, repairs shall be performed in accordance with para. 19.3.5. For fracture and unsoundness detected in drop test or hammering test, repairs are not permitted and the component shall be rejected.

### 19.4.3 Mass and Dimensional Inspection

Unless agreed otherwise, the verification of mass and dimensions is the responsibility of the manufacturer. The procedure of mass and dimensional inspection shall be agreed with PRS Surveyor. The mass of the anchor shall exclude the mass of the swivel, unless this is an integral component.

### 19.4.4 Re-tests

The requirements concerning re-tests are specified in sub-chapter 2.3, this *Part*.

### 19.4.5 Marking

**19.4.5.1** Anchors shall be marked in accordance with the requirements of sub-chapter 1.9, this *Part*, having regard to the below requirements.

**19.4.5.2** Admiralty type anchors and anchors with solid arms shall be marked on the anchor shank, close to the connection with the arms.

**19.4.5.3** The marks shall be struck (drawn or cast) on a special projection or framed, e.g. with a sett.

**19.4.5.4** Anchors with movable arms which meet the requirements of the Rules shall be stamped on the shank and each fluke. On the fluke, these markings shall be approximately at a distance of two-thirds from the tip of the bill to the centre line of the crown on the right hand fluke looking from the crown towards the shank.

**19.4.5.5** Additionally, the unique cast identification shall be cast on the shank and the fluke.

### 19.4.6 Inspection Certificate

For accepted anchors, *Inspection Certificate* is issued by PRS in accordance with the requirements of sub-chapter 1.8, this *Part*. In addition to particulars specified in sub-chapter 1.8, this *Part*, *Inspection Certificate* shall contain the following information:

- .1 anchor type,
- .2 proof test loads,
- .3 details of heat treatment,
- .4 marking (drawn or cast ) applied to anchor.

### 19.4.7 Painting

Anchors (all types) shall not be painted until all tests and inspections have been completed.



## 20 ANCHOR CHAIN CABLES AND ACCESSORIES

### 20.1 General Requirements

#### 20.1.1 Scope

**20.1.1.1** The requirements of the present Chapter apply to materials, design, manufacture and tests of anchor chain cables and accessories used for ships classified by PRS.

**20.1.1.2** Where studless short link chain cables are used with the consent of PRS, they shall comply with recognized standards or material specifications agreed with PRS.

**20.1.1.3** The requirements concerning chafing chain for Emergency Towing Arrangements (ETA) are given in sub-chapter 20.6.

#### 20.1.2 Chain Cables Grades

Depending on the nominal tensile strength of the chain cable steel used for manufacture, stud link chain cables are divided into Grades 1, 2 and 3, while studless short link chain cables – into Grades 1 and 2. The values of  $R_m$  for these grades are given in sub-chapter 11.5, this *Part*.

#### 20.1.3 Approval of Chain Manufacturer

Anchor chain cables and accessories shall be manufactured by works approved by PRS.

### 20.2 Materials

#### 20.2.1 Scope

The requirements of sub-chapter 20.2 apply to rolled steels, forgings and castings used for the manufacture of anchor chain cables and accessories.

#### 20.2.2 Requirements for Material Manufacturers

**20.2.2.1** All materials used for the manufacture of anchor chain cables and accessories shall be supplied by manufacturers approved by PRS. Approval is not required for Grade 1 steel bars.

**20.2.2.2** Materials suppliers or chain cable manufacturers shall submit, for information, specification for Grade 3 steel bars. The specification shall contain such data as manufacturing process, deoxydation practice, chemical composition, heat treatment, mechanical properties, etc.

#### 20.2.3 Rolled Steel Bars

Rolled steel bars used for the manufacture of chain cables and accessories shall comply with the requirements given in Chapter 11, this *Part*.

#### 20.2.4 Steel Forgings

**20.2.4.1** Unless provided otherwise in the present Chapter, steel forgings used for the manufacture of chain cables and accessories shall comply with the requirements specified in Chapter 12, this *Part*.

**20.2.4.2** The chemical composition shall comply with the specification approved by PRS. The steel manufacturer shall determine the chemical composition of every heat of material.

**20.2.4.3** The stock material shall be supplied in the as rolled condition. Finished forgings shall be properly heat treated, i.e. normalized, normalized and tempered or quenched and tempered, whichever is specified for the relevant steel grade in Table 20.3.5.1.

**20.2.5 Steel Castings**

**20.2.5.1** Unless provided otherwise in the present Chapter, steel castings used for the manufacture of chain cables and accessories shall comply with the requirements specified in Chapter 13, this Part.

**20.2.5.2** The chemical composition shall comply with the specification approved by PRS. The foundry shall determine the chemical composition of every heat of material.

**20.2.5.3** All castings shall be properly heat treated, i.e. normalized, normalized and tempered or quenched and tempered, whichever is specified for the relevant cast steel grade in Table 20.3.5.1.

**20.2.6 Materials for Studs**

**20.2.6.1** The studs shall be made from rolled, cast or forged steel or of steel corresponding to that of the chain cable.

**20.2.6.2** The use of other materials, e.g. grey or nodular cast iron is not permitted.

**20.3 Design and Manufacture of Chain Cables and Accessories**

**20.3.1 Design**

**20.3.1.1** Chain cables shall be manufactured according to relevant standards, e.g. ISO 1704:2008. Typical chain cable designs are given in Figs. 20.3.1-1 to 20.3.1-7. The dimensions, given in the figures, are a multiple of the nominal diameter of the common link.

The dimensions, given in brackets, apply to end swivel and studless link connected with the swivel.

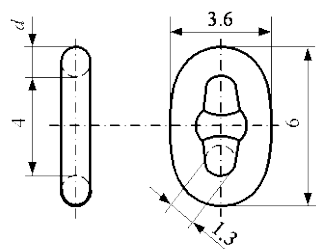

Fig. 20.3.1.1-1. Common link

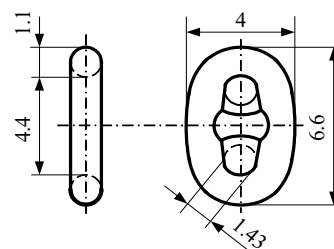

Fig. 20.3.1.1-2. Enlarged link

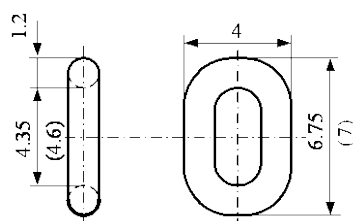

Fig. 20.3.1.1-3. Studless link

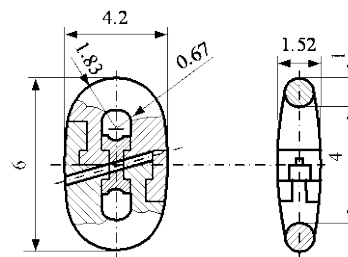

Fig. 20.3.1.1-4. Kenter shackle

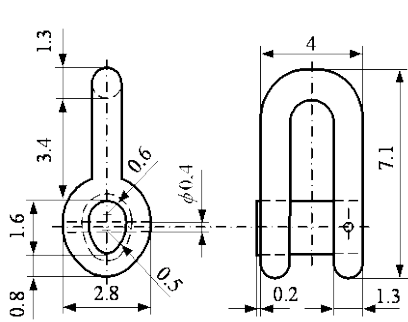

Fig. 20.3.1.1-5. Joining shackle

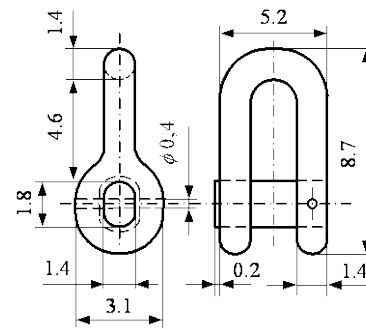

Fig. 20.3.1.1-6. End shackle

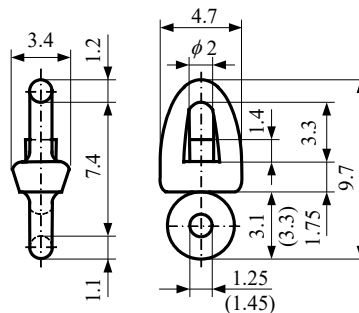

Fig. 20.3.1.1-7. Swivel

**20.3.1.2** A length of chain cable shall consist of an odd number of links. Where the chain design does not comply with the above requirements and where accessories are of welded construction, drawings giving full details of the manufacturing process, including heat treatment shall be submitted to PRS for approval.

### 20.3.2 Dimensions and Dimensional Tolerances

**20.3.2.1** The shape and dimensions of links and accessories shall comply with ISO 1704:2008 or technical documentation approved by PRS.

**20.3.2.2** Dimension tolerances of the link nominal diameter, measured at the crown, shall not exceed the values given in Table 20.3.2.2.

**Table 20.3.2.2**

Nominal diameter, $d$ [mm]	Negative dimension tolerances [mm]	The plus dimension tolerance [mm]
$d \leq 40$	-1	5% $d$
$40 < d \leq 84$	-2	
$84 < d \leq 122$	-3	
$d > 122$	-4	

**20.3.2.3** The cross-sectional area of the crown shall have no negative tolerance. Dimension tolerances of the weld diameter shall comply with the manufacturer's specification agreed with PRS.

Dimension tolerance of the link diameter, measured at locations other than the crown, shall be within  $(0 \div 5\%)d$ .

**20.3.2.4** The maximum allowable tolerance on assembly, measured over a length of 5 links, with the chain cable under tension after the proof load test, shall be within 0%,+2.5%.

**20.3.2.5** All other dimensions are subject to a manufacturing tolerance  $\pm 2.5\%$ , provided that all of the final link parts of the chain cable fit together properly.

**20.3.2.6** Studs shall be located in the links centrally and at right angles to the sides of the link. The studs of the final link at each end of any length may also be located off-centre to facilitate the insertion of the joining shackle.

The following tolerances are regarded as being inherent in the method of manufacture and will not be objected to, provided that the stud fits snugly and its ends lie practically flush against the inside of the link (see Fig. 20.3.2.6):

$X$  – off-centre distance: maximum 10% of the nominal diameter  $d$ ;

$\alpha$  – deviation: maximum  $4^\circ$ .

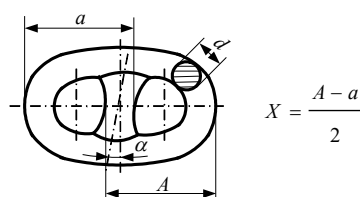

Fig. 20.3.2.6. Stud location in the link

**20.3.2.7** The following tolerances are applicable to accessories:

- nominal diameter: 0%, +5%,
- other dimensions:  $\pm 2.5\%$ .

### 20.3.3 Manufacturing Process

**20.3.3.1** Stud link chain cables shall be manufactured by flash butt welding method from Grade 1, 2 or 3 steel bars.

Manufacture of the links by drop forging or steel casting is permitted. Studless Grade 1 and 2 link chain cables with the nominal diameter not exceeding 26 mm may be manufactured by pressure butt welding.

**20.3.3.2** Accessories such as shackles, swivels and swivel shackles shall be forged or cast in steel of at least Grade 2, but not lower than the steel grade from which the chain was made.

Subject to PRS consent, the above accessories may be of welded construction.

### 20.3.4 The Welding of Studs

The welding of studs shall be in accordance with an approved, by PRS, procedure, having regard to the following conditions:

- the studs shall be made of weldable unalloyed steel;
- the studs shall be welded at one end only, i.e. opposite to the weldment of the link. The stud ends must fit the inside of the link without appreciable gap;
- the welds shall be performed in the downhand position, by qualified welders using suitable welding consumables;
- all welds shall be performed before the final heat treatment of the chain cable;
- the welds shall be free from defects liable to impair the proper use of the chain.

Undercuts, end craters and similar defects shall, where necessary, be ground off. PRS may require that the tests of welding chain studs should be performed to ascertain that the proposed welding technique is suitable.

### 20.3.5 Supply Condition

**20.3.5.1** Depending on the steel grade, chain cables and accessories shall be supplied in one of the conditions specified in Table 20.3.5.1.

**Table 20.3.5.1**  
**Supply condition of chain cables and accessories**

Grade	Chain cable	Accessories
1	As welded or normalized	-
2	As welded or normalized <sup>1)</sup>	Normalized
3	Normalized, normalized and tempered or quenched and tempered	Normalized, normalized and tempered or quenched and tempered

**Note:**

<sup>1)</sup> Grade 2 chain cables made by forging or casting shall be supplied in the normalized condition.

**20.3.5.2** The heat treatment of chain cables and accessories shall be performed in each case before the chain tests.

**20.3.5.3** The mechanical properties of finished chain cables and accessories shall comply with Table 20.4.3.3.

### 20.3.6 Freedom from Defects

**20.3.6.1** All individual parts of the chain cable shall have a clean surface consistent with the method of manufacture and shall be free from cracks, notches, inclusions and other defects impairing the performance of the product. The flashes produced by upsetting or drop forging shall be properly removed.

**20.3.6.2** Minor surface defects may be ground off so as to leave a gentle transition to the surrounding surface. Remote from the crown local grinding up to 5% of the nominal link diameter may be permitted.

## 20.4 Testing and Inspection Certificate of Finished Chain Cables

### 20.4.1 Proof and Breaking Load Tests

**20.4.1.1** The finished chain cables shall be subjected to the proof load test and the breaking load test in the presence of PRS Surveyor. The chain cables shall not fracture or exhibit cracking during the tests. Special attention shall be given to the inspection of the flash-butt weld, if present. For this purpose, the chain cables shall be free from paint and anti-corrosion media.

**20.4.1.2** Each chain cable (27.5 m) shall be subjected to a proof load test using an approved testing machine.

**20.4.1.3** The design and/or standard breaking loads (BL) and proof loads (PL) of stud link chain cables are given in Table 20.4.1.3-1 for the chain diameter,  $d$ , in mm. The test load values, rounded off from the loads above to be used for testing and acceptance of chain cables, are given in Table 20.4.1.3-2.

**Table 20.4.1.3-1**  
**Breaking loads and proof loads of stud link chain cables**

Test	Grade 1 chain	Grade 2 chain	Grade 3 chain
Breaking load [kN]	$BL_1 = 9,80665 \cdot 10^{-3} \cdot d^2 (44-0.08 \cdot d)$	$BL_2 = 1.4 BL_1$	$BL_3 = 2 BL_1$
Proof load [kN]	$PL_1 = 0.7 BL_1$	$PL_2 = BL_1$	$PL_3 = 1.4 BL_1$

**Note:**  $d$  – nominal diameter, [mm].



**Table 20.4.1.3-2**  
**Test load values for stud link chain cables**

Chain cable diameter [mm]	Grade 1		Grade 2		Grade 3	
	Proof load [kN]	Breaking load [kN]	Proof load [kN]	Breaking load [kN]	Proof load [kN]	Breaking load [kN]
11 <sup>1)</sup>	35.8	51	51	71.7	71.7	102
12.5 <sup>1)</sup>	46	65.7	65.7	92	92	132
14 <sup>1)</sup>	57.9	82	82	116	116	165
16 <sup>1)</sup>	75.5	107	107	150	150	216
17.5 <sup>1)</sup>	89	127	127	179	179	256
19 <sup>1)</sup>	105	150	150	211	211	301
20.5	123	175	175	244	244	349
22	140	200	200	280	280	401
24	167	237	237	332	332	476
26	194	278	278	389	389	556
28	225	321	321	449	449	642
30	257	368	368	514	514	735
32	291	417	417	583	583	833
34	328	468	468	655	655	937
36	366	523	523	732	732	1050
38	406	581	581	812	812	1160
40	448	640	640	896	896	1280
42	492	703	703	981	981	1400
44	583	769	769	1080	1080	1540
46	585	837	837	1170	1170	1680
48	635	908	908	1270	1270	1810
50	686	981	981	1370	1370	1960
52	739	1060	1060	1480	1480	2110
54	794	1140	1140	1590	1590	2270
56	851	1220	1220	1710	1710	2430
58	909	1290	1290	1810	1810	2600
60	969	1380	1380	1940	1940	2770
62	1030	1470	1470	2060	2060	2940
64	1100	1560	1560	2190	2190	3130
66	1160	1660	1660	2310	2310	3300
68	1230	1750	1750	2450	2450	3500
70	1290	1840	1840	2580	2580	3690
73	1390	1990	1990	2790	2790	3990
76	1500	2150	2150	3010	3010	4300
78	1580	2260	2260	3160	3160	4500
81	1690	2410	2410	3380	3380	4820
84	1800	2580	2580	3610	3610	5160
87	1920	2750	2750	3850	3850	5500
90	2050	2920	2920	4090	4090	5840

Chain cable diameter [mm]	Grade 1		Grade 2		Grade 3	
	Proof load [kN]	Breaking load [kN]	Proof load [kN]	Breaking load [kN]	Proof load [kN]	Breaking load [kN]
92	2130	3040	3040	4260	4260	6080
95	2260	3230	3230	4510	4510	6440
97	2340	3340	3340	4680	4680	6690
100	2470	3530	3530	4940	4940	7060
102	2560	3660	3660	5120	5120	7320
105	2700	3850	3850	5390	5390	7700
107	2790	3980	3980	5570	5570	7960
111	2970	4250	4250	5940	5940	8480
114	3110	4440	4440	6230	6230	8890
117	3260	4650	4650	6510	6510	9300
120	3400	4850	4850	6810	6810	9720
122	3500	5000	5000	7000	7000	9990
124	3600	5140	5140	7200	7200	10280
127	3750	5350	5350	7490	7490	10710
130	3900	5570	5570	7800	7800	11140
132	4000	5720	5720	8000	8000	11420
137	4260	6080	6080	8510	8510	12160
142	4520	6450	6450	9030	9030	12910
147	4790	6840	6840	9560	9560	13660
152	5050	7220	7220	10100	10100	14430
157	5320	7600	7600	10640	10640	15200
162	5590	7990	7990	11170	11170	15970

<sup>1)</sup> Anchor chain cable diameters below 20.5 mm apply to ships with equipment number EN below 250.

**20.4.1.4** The breaking load shall be determined on three links – in the case of stud link chain cable or five links – in the case of studless link chain cable. The links concerned shall be made in a single manufacturing cycle, together with the chain cable and shall be welded and heat treated with it. Only after this they may be separated from the chain cable in the presence of PRS Surveyor. The breaking load shall be in accordance with Tables 20.4.1.3-1 and 20.4.1.3-2. The breaking load shall be maintained for a minimum of 30 seconds.

**20.4.1.5** Where the required breaking load for large diameter cables is greater than the capacity of the testing machine – the type and scope of alternative testing methods shall be specially agreed with PRS.

## 20.4.2 Re-tests

**20.4.2.1** Where the breaking load test on three link specimen fails, a further specimen may be taken from the same length of chain cable and tested. If the re-test fails, the length of the chain cable shall be rejected.

If the manufacturer so wishes, additional three link specimens may be taken from the remaining lengths and subjected to breaking test. If one such test fails, the entire set of lengths shall be rejected.

**20.4.2.2** Where the proof load test fails, the defective links shall be replaced, the new links being subjected to local heat treatment. The chain cable length shall be subjected to a further proof load test. An investigation shall be also made to identify the cause of the failure.

### 20.4.3 Mechanical Tests of Grade 2 and 3 Chain Cables

**20.4.3.1** For Grade 2 and 3 chain cables, mechanical test specimens as required in Table 20.4.3.1 shall be taken from every fourth length. For forged or cast chain cables where the batch size is less than four lengths, the sampling frequency will be by heat and heat treatment charge. Mechanical tests shall be performed in the presence of PRS Surveyor. Location of the test specimens is given in Fig. 11.6.3, this *Part*. The tests shall be performed in accordance with sub-chapter 11.6, this *Part*. Re-tests shall be in accordance with 11.6.4, this *Part*.

**Table 20.4.3.1**  
**Extent of mechanical tests for finished cables and accessories**

Grade	Method of manufacture	Supply condition <sup>1)</sup>	Number of test specimens		
			Tensile test of parent material	Impact test	
				parent material	weldment
1	flush-butt welded	AW	NR	NR	NR
		N			
2	flush-butt welded	AW	1	3	3
		N	NR	NR	NR
	drop forged or cast	N	1	3 <sup>2)</sup>	NA
3	flush-butt welded	N, NT, QT	1	3	3
	drop forged or cast	N, NT, QT	1	3	NA

<sup>1)</sup> AW – as welded, N – normalized, NT – normalized and tempered, QT – quenched and tempered.  
<sup>2)</sup> For chain cables, Charpy V-notch impact is not required.  
NR – not required, NA – not applicable

**20.4.3.2** To take the required set of specimens, an additional link/or, where links are small, a link or several link shall be provided in a length of chain cable. The mechanical test specimens shall not be taken from the same length as that from which the breaking test three link specimens have been prepared. The specimen link shall be manufactured and heat-treated together with the length of chain cable. The additional links shall be made in accordance with the requirements of 20.4.1.4.

**20.4.3.3** The mechanical properties of completed chain cables shall be in accordance with the values specified in Table 20.4.3.3.

**Table 20.4.3.3**  
**Mechanical properties of finished chain cables and accessories**

Grade	Tensile test				Impact test <sup>1)</sup>		
	$R_e$ [MPa] min.	$R_m$ [MPa]	$A$ [%] min.	$Z$ [%] min.	Test temperature [°C]	Impact energy [J] min.	
						Parent material	Weldment
1	NR	NR	NR	NR	NR	NR	
2	295	490-690	22	NR	0	27	
3	410	min. 690	17	40	0 <sup>2)</sup>	60	
					-20	35	

<sup>1)</sup> Average value from 3 test specimens. One individual value only may be below the specified average value, provided it is not less than 70% of that value.

<sup>2)</sup> Testing shall normally be performed at 0°C.

NR – not required.



#### 20.4.4 Marking

Chain cables shall be marked in accordance with the requirements of sub-chapter 1.9, this *Part*, having regard to the requirements given below.

Both ends of the chain cable length, as well as all accessories which meet the requirements of the present Chapter, shall be stamped with at least the marks given in Fig. 20.4.4.

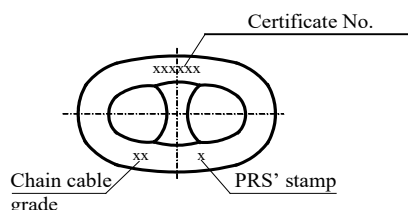

Fig. 20.4.4

#### 20.4.5 Inspection Certificate

For accepted chain cables, *Inspection Certificate* is issued by PRS in accordance with the requirements of sub-chapter 1.8, this *Part*. In addition to particulars specified in sub-chapter 1.8, this *Part*, *Inspection Certificate* shall contain the following information:

- .1 nominal diameter and weight,
- .2 proof and breaking loads,
- .3 heat treatment parameters,
- .4 marks stamped on the chain.

#### 20.5 Testing and Inspection Certificate for Accessories

##### 20.5.1 Proof Load Test

All chain cable accessories shall be subjected to the proof load test according to the requirements of Tables 20.4.1.3-1 and 20.4.1.3-2, prescribed for the given chain grade and diameter.

##### 20.5.2 Breaking Load Test

**20.5.2.1** From each manufactured batch (the same grade, size and heat treatment batch) of 25 items or less of shackles, swivels, swivel shackles, large links and end links, and from each manufactured batch of 50 items or less of Kenter shackles, one item, selected at random, shall be subjected to the breaking load test. The tested item cannot be further used.

**20.5.2.2** PRS may waive the breaking load test if:

- the breaking load has been demonstrated at the time of acceptance tests, and
- the mechanical properties of each manufactured batch have been determined, and
- chain cables accessories have been subjected to non-destructive tests, agreed with PRS.

**20.5.2.3** The accessories which have been satisfactorily tested at the prescribed breaking load appropriate to the chain, may be used in service at the discretion of PRS where the accessories are manufactured with the following:

- the material having higher strength characteristics than those specified for the part in question (e.g. Grade 3 material for Grade 2 chain), or
- the same grade as that of the chain, but with increased dimensions subject to the successful procedure tests that such accessories are so designed that the breaking strength is not less than 1.4 times the prescribed breaking load of the chain for which they are intended.

### 20.5.3 Mechanical Properties

**20.5.3.1** From each batch, a set comprising 1 tensile test specimen and 3 impact test specimens shall be taken in accordance with the requirements of sub-chapter 11.6, this Part.

**20.5.3.2** The test results shall comply with the requirements given in Table 20.4.3.3. Re-tests shall be performed in accordance with para. 20.4.2. Enlarged links and end links need not be tested, provided that they are manufactured and heat treated together with the chain cable.

### 20.5.4 Marking

Accessories shall be marked in accordance with the requirements of sub-chapter 1.9, this Part. Additionally, the marking shall contain the chain cable Grade.

### 20.5.5 Inspection Certificate

For accepted accessories, *Inspection Certificate* is issued by PRS in accordance with the requirements of sub-chapter 1.8, this Part. In addition to particulars specified in sub-chapter 1.8, this Part, *Inspection Certificate* shall contain the following information:

- .1 nominal diameter and weight,
- .2 proof and breaking loads,
- .3 heat treatment parameters,
- .4 marks stamped on the accessories,
- .5 length.

## 20.6 Chafing Chain for ETA Equipment

### 20.6.1 Application

The requirements of the present sub-chapter apply to the chafing chain for chafing gear of Emergency Towing Arrangements (ETA)<sup>1)</sup> with specified working load (SWL) of 1000 kN (ETA1000) and 2000 kN (ETA2000). Chafing chains other than those specified can be used subject to agreement with PRS.

### 20.6.2 Approval of the Manufacturer

The chafing chains for ETA equipment shall be manufactured at works approved by PRS, in accordance with the manufacturing process agreed with PRS.

### 20.6.3 Materials

The materials used for the manufacture of the chafing chain shall comply with the requirements set forth in sub-chapter 20.2, this Part.

### 20.6.4 Design, Manufacture, Testing and Acceptance of Chafing Chain

**20.6.4.1** The chafing chain shall be designed, manufactured, tested and accepted in accordance with the requirements set forth in sub-chapters 20.3, 20.4 and 20.5.

---

<sup>1)</sup> Chafing chain – short chain segment constituting the end of a towing or mooring rope protecting from the rope chafing against the chock.

ETA (Emergency Towing Arrangements) equipment – arrangements for towing a ship which has lost its propulsion or steerability as a result of breakdown.

**20.6.4.2** The arrangement at the end connected to the strongpoint and the dimensions of the chafing chain are determined by the type of ETA. The other end of the chafing chain shall be fitted with a pear-shaped open link allowing connection to a shackle corresponding to the type of ETA and chain cable grade. A typical arrangement of such chain end is shown in Fig. 20.6.4.2.

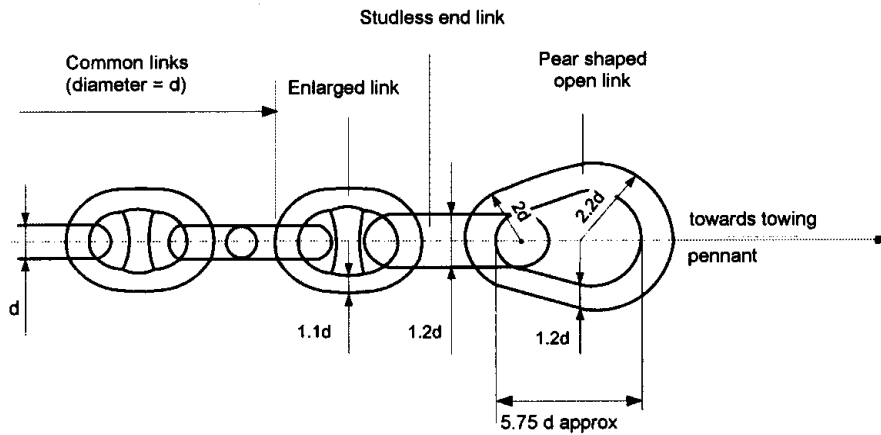

Fig. 20.6.4.2. Typical outboard chafing chain end

**20.6.4.3** The chafing chain links shall be common links of stud link type Grade 2 or 3.

**20.6.4.4** The chafing chain shall be able to withstand a breaking load not less than twice the SWL. For each ETA equipment, the nominal diameter of common link for chafing chains shall comply with the values given in Table 20.6.4.4.

**Table 20.6.4.4**  
**Nominal Diameter of Common Link for Chafing Chain**

Type of ETA	Nominal diameter of common link $d_{min}$ , [mm]	
	Grade 2	Grade 3
ETA 1000	62	52
ETA 2000	90	76

## 21 STEEL WIRE ROPES

### 21.1 General Requirements

**21.1.1** The requirements of the present chapter are applicable to steel wire ropes used in cargo handling gear, towing, mooring, anchoring equipment and life-saving appliances subject to PRS survey.

**21.1.2** Wire ropes shall be manufactured in works approved by PRS and shall comply with the requirements specified in the *Rules* or material specifications (standards) agreed with PRS.

### 21.2 Manufacture

**21.2.1** Steel wires used for the manufacture of ropes shall have a round cross-section, be galvanized and have 1550, 1770, 1960 or 2160 MPa<sup>1)</sup> tensile strength.

The use of wires with a tensile strength different from that specified above shall be specially agreed with PRS.

**21.2.2** Ropes intended for running rigging shall be made from zinc coated class B<sup>1)</sup> wires.

Ropes for standing rigging, as well as towing, mooring and anchor ropes shall be made from zinc coated class A<sup>1)</sup> wires.

**21.2.3** The fibre cores (FC) of the ropes shall be made of new natural fibres (sisal, manila) or new synthetic fibres (polyethylene, polypropylene, polyamide).

The main core shall be constructed of at least 3 strands and shall constitute a single length, of the same diameter and structure. In ropes of less than 8 mm in diameter, one-strand fibre cores are permitted.

**21.2.4** Where wire-rope cores are used, these shall be steel independent wire-rope cores (IWRC). Independent wire strand cores (WSC) may be used in ropes of less than 13 mm in diameter (in ropes with greater diameter, only where provided for by recognized standard), as well as in all multilayer ropes.

**21.2.5** Where steel core is included in the wire cross-section, the wires used for its manufacture shall be of the same tensile strength as that of the wire ropes.

**21.2.6** In the completed rope, all wires shall be lubricated to protect them against corrosion. Natural fibre cores shall be treated with anticorrosive and rotproofing compounds insoluble in sea water and containing neither acids nor alkalis.

Wires and natural fibre cores shall be covered with compatible lubricants.

### 21.3 Tests

**21.3.1** Each rope shall be tested to destruction to determine the actual breaking load of the completed rope.

Additionally, not less than 10% of wires in the rope shall be subjected to reverse bend test, torsion test and the zinc coating inspection in accordance with PN-EN 10264-2.

**21.3.2** The minimum breaking load  $F_{min}$  of the rope shall be calculated from the formula (according to PN-EN 12385-2):

---

<sup>1)</sup> Designation according to PN-EN 10264-2.

$$F_{min} = \frac{d^2 \cdot R_r \cdot K}{1000} \text{ [kN]} \quad (21.3.2)$$

where:

$d$  – the rope nominal diameter, [mm],

$R_r$  – rope strength class,

$K$  – the rope minimum breaking load factor (see Table 21.3.7).

**21.3.3** The test length of the tensile test sample shall comply with the requirements given in Table 21.3.3 and Fig. 21.3.3.

**Table 21.3.3**  
**Rope test length acc. to ISO 3108**

Rope diameter $d$ [mm]	Specimen minimum test length $l$ [mm]
$d \leq 6$	300
$6 < d \leq 20$	600
$d > 20$	$30 \times d$

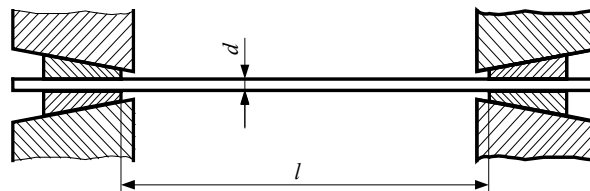

Fig. 21.3.3

**21.3.4** For the purpose of testing, from each manufactured rope of up to 10 000 m in length, of the same nominal diameter, wire strength class, zinc coating class and the rope construction, one test sample shall be taken; from the rope of 10 000 m in length and above – two test samples, one at each end.

**21.3.5** When performing the breaking test, the breaking load shall be applied quickly until 80% of the minimum breaking load, calculated according to formula (21.3.2), is obtained, and then the load shall be applied slowly so that the stress in the rope will rise at a speed of approx. 10 MPa/s.

**21.3.6** The actual breaking load of the rope is obtained if a breakage of at least one strand occurs. If the specimen breakage occurs within a distance less than 50 mm from the machine grip and the minimum breaking load is not obtained, the test shall be considered as not reliable and shall be repeated.

**21.3.7** Table 21.3.7 presents steel wire ropes for general application, having regard to the rope construction (class), construction of strands and the minimum breaking load factors.

**Table 21.3.7**  
**Steel wire ropes (acc. to PN-EN 12385-4)**

Class	Examples of wire cross-sections <sup>1)</sup>	Construction		The rope and core minimum breaking load factor <sup>3)</sup>		
		Rope <sup>2)</sup>	Strand	$K_1$	$K_2$	$K_3$
6x7	6x7-FC	6x7	1-6	0.332	0.359	0.388
8x7	8x7-FC	8x7	1-6	0.291	0.359	0.404
6x19	6x19S-FC 6x25F-FC	6x19S 6x25F 6x19W 6x26WS	1-9-9 1-6-6F-12 1-6-6+6 1-5-5+5-10	0.330	0.356	
8x19	8x19S-IWRC 8x25F-IWRC	8x19S 8x25F 8x19W 8x26WS	1-9-9 1-6-6F-12 1-6-6+6 1-5-5+5-10	0.293	0.356	
6x36	6x36WS-IWRC 6x41WS-IWRC	6x31WS 6x36WS 6x41WS 6x49WS 6x46WS	1-6-6+6-12 1-7-7+7-14 1-8-8+8-16 1-8-8-8+8-16 1-9-9+9-18	0.330	0.356	
8x36	8x36WC-IWRC	8x31WS 8x36WS 8x41WS 8x49WS 8x46WS	1-6-6+6-12 1-7-7+7-14 1-8-8+8-16 1-8-8-8+8-16 1-9-9+9-18	0.293	0.356	
6x35N	6x35NW-FC	6x28NW 6x23NW 6x34NW 6x35NW	1-5-5+5/12 1-6-6+6/14 1-6-6+6/15 1-6-6+6/16	0.317	0.345	
6x19M	6x19M-WSC	6x19M	1-6/12	0.307	0.362	
6x37M	6x37M-FC	6x37M	1-6/12/18	0.295	0.395	0.346
18x7	17x7-FC 18x7-FC	17x7 18x7	1-6 1-6	0.328	0.328	
34(M)x7	34(M)x7-FC	34(M)x7 36(M)x7	1-6 1-6	0.318	0.318	
35(W)x7	35(W)x7	35(W)x7	1-6	0.360	0.350	

<sup>1)</sup> Type of core: FC – fibre core, IWRC – independent wire rope core, WSC – independent wire strand core.  
<sup>2)</sup> Construction of strands:  
– with linear contact: S – Seale, W – Warrington, F – Filler,  
– with combined linear contact: WS – Warrington/Seale,  
– multi-operations coiling: M – point contact, N – combined contact.  
<sup>3)</sup>  $K_1$  – factor for stranded ropes with fibre cores (single-layer rope) or fibre centre (non-rotating ropes),  
 $K_2$  – factor for stranded ropes with independent wire rope core,  
 $K_3$  – factor for stranded ropes with wire strand core (non-rotating ropes).

## 21.4 Inspection of Surface and Work Quality

**21.4.1** Compliance of the construction, diameter and other parameters of the rope with the requirements of the present Chapter and the order conditions shall be verified by external examination and measurements.

**21.4.2** The ends of all steel wire ropes shall be protected against unstranding by bonds.

After removal of the bonds from the ends of the wire rope, the strands in the rope and wires in the strands shall not unstrand or shall unstrand to such an extent that they can easily return to their initial position.

**21.4.3** The actual diameter of the rope shall be measured on the rope straight unloaded section in two points, spaced at least 1 m.

In each of the points, at least two measurements shall be made in two, perpendicular to the rope axis, directions, between two opposite strands.

Dimension tolerance of ropes with 8 mm and more of nominal diameter shall be within:

- 1%, +4% for ropes with strands constructed exclusively of wires,
- 1%, +6% – for ropes with strands constructed of fibre cores.

## 21.5 Marking

Steel wire ropes shall be marked in accordance with sub-chapter 1.9, this *Part*. Additionally, the marking shall contain the following particulars:

- .1 rope construction (class),
- .2 rope length,
- .3 rope nominal diameter,
- .4 minimum pre-strain force, kN,
- .5 coil (reel) No.

## 21.6 Inspection Certificate

For accepted ropes, *Inspection Certificate* is issued by PRS in accordance with the requirements of sub-chapter 1.8, this *Part*. Additionally, the following particulars shall be given:

- .1 rope nominal diameter,
- .2 rope actual diameter,
- .3 rope length,
- .4 rope construction,
- .5 rope lay (type, direction),
- .6 wire strength,
- .7 wire surface treatment,
- .8 the actual breaking load,
- .9 coil (reel) No.

## 22 FIBRE ROPES

### 22.1 General Requirements

**22.1.1** The requirements of the present Chapter are applicable to fibre ropes used in towing, mooring equipment, cargo handling gear, life-saving appliances and other equipment provided on ships subject to PRS survey.

**22.1.2** Fibre ropes shall be manufactured at works approved by PRS and shall comply with the requirements specified in the *Rules* or material specifications (standards) agreed with PRS.

### 22.2 Manufacture

**22.2.1** Fibre ropes shall be manufactured from new natural fibres (sisal, manila) or new synthetic fibres (polyamide, polyester, polypropylene, polyethylene).

**22.2.2** The basic parameters of stranded or plaited fibre ropes shall comply with the relevant standards agreed with PRS.

**22.2.3** Ropes and the rope strands shall constitute a single length, without joints on standard length in delivery or a smaller length.

**22.2.4** Ropes shall be manufactured in accordance with PN-EN ISO 9554 to ensure dimensions stability, resistance to the effects of sunlight (for synthetic ropes), mould and bacteria (for natural fibre ropes). Ropes shall be resistant to petroleum products.

The content of titanium dioxide in the polyamide and polyester ropes cannot exceed 0.05%. The ropes shall be heat treated to fix the strand and to stabilize dimensions.

**22.2.5** Ropes shall be identified with a thread or tape, easily recognizable despite getting dirty, wet or fading. The tape shall be at least 3 mm wide and shall be printed with the number of the relevant ISO standard and a reference number identifying the manufacturer. The maximum distance between two consecutive marks shall be 0.5 m.

### 22.3 Tests

**22.3.1** Each rope shall be tested to destruction to determine the actual breaking load of the completed rope.

Each type of rope shall be additionally subjected, one time, to ageing in accordance with *Publication 40/P – Non-Metallic Materials* and subsequently to tensile test according to the requirements of the present Chapter.

The mechanical properties shall not be reduced by more than 30% in relation to the initial value.

**22.3.2** The effective lengths of test samples and the types of testing machine grips are given in Table 22.3.2 and Figures 22.3.2-1, 22.3.2-2 and 22.3.2-3.



**Table 22.3.2**  
**Effective lengths acc. to PN-EN ISO 2307**

Type of rope	Type of testing machine grips	Minimum effective length $L_u$ [mm]
Synthetic ropes with reference number $\leq 10$	all types	400
Synthetic ropes with reference number $> 10$ and $< 20$	"cors de chasse"	400
	pins	1000
	wedge grips	-
Synthetic ropes with reference number $\geq 20$	pins	2000 <sup>1)</sup>
Natural fibre ropes	all types	2000

<sup>1)</sup> If the length of the lay is greater than 360 mm,  $L_u$  shall be increased to 5 lengths, where possible.

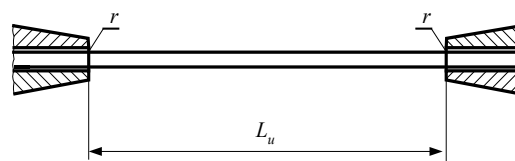

Fig. 22.3.2-1. The effective length  $L_u$  for wedge grips testing machine, applicable to ropes with reference number  $< 20$   
 $r$  – limiting marks for standard test,  $L_u$  – the effective length measured under zero tension

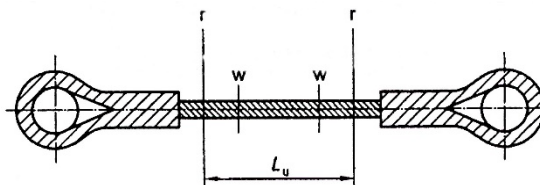

Fig. 22.3.2-2. The effective length  $L_u$  for pin grip testing machine, applicable to ropes with reference number  $\geq 20$   
 $r$  – limiting marks for standard test,  $L_u$  – the effective length measured under zero tension,  $w$  – two marks on test specimen

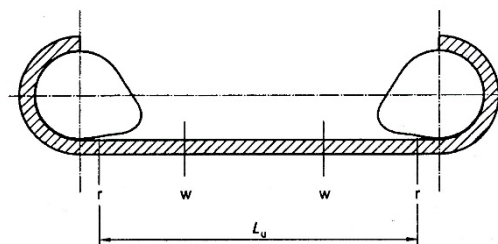

Fig. 22.3.2-3. The effective length  $L_u$  for cors de chasse testing machine, applicable to ropes with reference number  $< 20$   
 $r$  – limiting marks for standard test,  $L_u$  – the effective length measured under zero tension,  $w$  – two marks on test specimen

**22.3.3** The test results shall comply with the requirements given in standards or material specifications agreed with PRS.

**22.3.4** At the purchaser's consent, the actual breaking load  $F_c$  of three-strand, four-strand, eight-strand and twelve-strand rope with reference number greater than 44 may be determined from the formula:

$$F_c = F_y \cdot n \cdot f_r \quad [\text{N}] \quad (22.3.4)$$

$F_y$  – the average strength of threads, [N]

$n$  – number of threads in the rope;  
 $f_r$  – correction factor <sup>1)</sup>.

**22.3.5** The elongation  $E$ , in percentage, during the breaking test of synthetic ropes shall be determined from the formula <sup>1)</sup>:

$$E = \frac{L_3 - L_2}{L_2} \cdot 100 [\%] \quad (22.3.5)$$

where:

$L_2$  – the gauge length of the rope sample under initial stress, [mm];  
 $L_3$  – the gauge length of the rope sample under the stress equal to 50 of the required minimum breaking load, [mm].

## 22.4 Inspection of Surface and Work Quality

Compliance of the rope construction, circumference and other dimensions with the relevant standard or material specifications agreed with PRS shall be verified by external examination and measurements.

The defects which disqualify the rope are: mould, partial melting, the smell of rot or burning.

Criteria for the rope resplice and retirement are given in PN-EN ISO 9554.

## 22.5 Marking

Ropes shall be marked in accordance with the requirements of sub-chapter 1.9, this *Part*. Additionally, the marking shall contain the following particulars:

- .1 constituent material,
- .2 manufacturer's identification and the country of origin,
- .3 reference number,
- .4 delivery length,
- .5 declaration of conformity to standard relating to the constituent material.

## 22.6 Inspection Certificate

For accepted ropes, *Inspection Certificate* is issued by PRS in accordance with the requirements of sub-chapter 1.8, this *Part*. Additionally, the following particulars shall be given:

- .1 constituent material,
- .2 rope construction (number of strands, lay of a rope, etc.),
- .3 treatment of rope,
- .4 reference number,
- .5 confectioning length,
- .6 reference to standard relating to the constituent material.

---

<sup>1)</sup> E.g. acc. to PN-ISO 2307.

## **WELDING**

## 23 WELDING

### 23.1 General

**23.1.1** The requirements specified in Chapter 23 apply to welding of the structures subject to technical survey by PRS during both their construction and repair. Works using welding processes for construction or repair of such structures shall have valid approval by PRS to the welding in the scope covering the work performed.

Welders shall hold valid PRS qualification certificates relevant to the work performed.

Qualification of welders for welding structures subject to PRS survey is conducted in accordance with PRS requirements provided in *Publication 30/P – Principles for Certification of Welders* or in the requirements of recognised standards, e.g. IACS UR W32, a set of standards PN-EN ISO 9606, ASME Sec. IX or ANSI/AWS D1.1.

Welding of high manganese austenitic stainless steel used for construction of cargo and fuel tanks of LNG carriers and LNG-fuelled ships shall be in accordance with *Interim Guidelines on the Application of High Manganese Austenitic Stainless Steel for Cryogenic Service* (IMO MSC.1/Circ. 1599/Rev. 2).

Welding works for brittle crack arrest steels shall be in accordance with the relevant requirements for each steel grade excluding suffix BCA1 or BCA2 specified in Chapter 3.

**23.1.2** When the welding process is performed in the open air, at low temperature and high humidity, means shall be provided to ensure the required quality of welded joints. Preheating, depending on the type and thickness of the welded materials, as well as ambient temperature shall be agreed with PRS.

**23.1.3** Structure documentation shall contain information on all welded joints in the structure, indicating: type of the welded joint, type of weld, weld dimensions, weld groove dimensions, the thickness transition in butt welds where elements of different thickness are welded.

These particulars may be given in the drawings or in the *Welding table*, which shall constitute an integral part of the structure documentation.

**23.1.4** Edges of structures to be welded shall be prepared in accordance with the technical documentation and methods approved by PRS.

**23.1.5** The edges prepared for welding shall be free from oil, scale rust, paint and substances which form at a very low temperature such as snow, hoarfrost, etc. Welding of structures with the shop primer is permitted, provided the paint is approved by PRS as not having significant harmful effect on the quality of welded joints in accordance with PN-EN ISO 17652 Standard.

**23.1.6** Welding sequence shall be such as to avoid excessive residual stresses and permanent distortions.

**23.1.7** Welding under water and welding of the structures, the other side of which is in contact with water shall be agreed with PRS.

Inspections of underwater welded joints shall be performed in accordance with the requirements specified in *Publication 34/P – Inspection of Underwater Welded Joints*.

**23.1.8** When plates, sheets, patches or the like are welded into a rigid contour, processing measures shall be taken to decrease the stresses due to welding. Opening with closed perimeter is considered to have a rigid contour if one of its dimensions is less than 60 plate thicknesses in the particular place.

**23.1.9** Straightening of structures is allowed within reasonable limits. Straightening may be done by heating with the use of load or without load; damage to the weld or plate surface is not permitted. The heating temperature during straightening welded hull structural steel shall not exceed 650°C and the heating process shall not change the structural properties of the material.

Straightening by heating, with simultaneous water-cooling, may be used, provided that the straightening procedure shall be agreed with PRS and the personnel qualifications are confirmed.

The method of heating and intensity of cooling, as well as the maximum heating temperature shall be appropriate for the properties and thickness of the material.

**23.1.10** Heat treatment after welding is required in the case when residual thermal stresses shall be eliminated. The type of heat treatment shall be determined according to the properties of the material and shall be agreed with PRS in each particular case.

**23.1.11** The components made of cold-bent hull structural steel may be welded without heat treatment if the inner radius of bending is greater than 3 times the plate thickness.

**23.1.12** Hydrogen-controlled welding consumables shall be protected against humidity and shall be dried up according to the manufacturer’s recommendations prior to application.

## 23.2 Welding of Ship Hull and its Equipment

**23.2.1** Consumables for welding particular normal and higher strength hull structural steel grades shall be selected in accordance with Table 23.2.1-1, whereas consumables for welding high strength structural steel shall be selected in accordance with Table 23.2.1-2.

**Table 23.2.1-1**  
**Consumables for welding normal and higher strength hull structural steel grades**

Grades of welding consumables <sup>3)</sup>	Hull structural steel grades											
	A	B	D	E	AH32 AH36	DH32 DH36	EH32 EH36	FH32 FH36	AH40	DH40	EH40	FH40
1	x											
1Y	x				x <sup>2)</sup>							
2	x	x	x									
2Y	x	x	x		x	x						
2Y40	1)	1)	1)		x	x			x	x		
3	x	x	x	x								
3Y	x	x	x	x	x	x	x					
3Y40	1)	1)	1)	1)	x	x	x		x	x	x	
4Y	x	x	x	x	x	x	x	x				
4Y40	1)	1)	1)	1)	x	x	x	x	x	x	x	x
5Y40	1)	1)	1)	1)	x	x	x	x	x	x	x	x

1) Welding consumables approved for welding steel of Grades AH40, DH40, EH40 and FH40 may be used for welding the corresponding grades of normal strength hull structural steel subject to PRS agreement in each particular case.

2) Welding consumables of Grade 1Y may be used for welding higher strength hull structural steel up to 25 mm in thickness.

3) Grade notation of welding consumables for semi-automatic welding is supplemented with letter S; grade notation of consumables for automatic welding is supplemented with the following letters:

T – for two-run technique,

M – for multi-run technique,

TM – for two-run and multi-run techniques.

Example: 3YS, 3YT, 3YM, 3YTM, 3Y40S.

**Table 23.2.1-2**  
**Selection of consumables for welding high strength steel**

Grade of welding consumables	High strength steel grades																						
	A420 D420	E420	F420	A460 D460	E460	F460	A500 D500	E500	F500	A550 D550	E550	F550	A620 D620	E620	F620	A690 D690	E690	F690	A890 D890	E890	A960 D960	E960	
3Y42	x																						
4Y42	x	x																					
5Y42	x	x	x																				
3Y46	x			x																			
4Y46	x	x		x	x																		
5Y46	x	x	x	x	x	x																	
3Y50	x			x			x																
4Y50	x	x		x	x		x	x															
5Y50	x	x	x	x	x	x	x	x	x														
3Y55							x			x													
4Y55							x	x		x	x												
5Y55							x	x	x	x	x	x											
3Y62										x			x										
4Y62										x	x		x	x									
5Y62										x	x	x	x	x	x								
3Y69													x			x							
4Y69													x	x		x	x						
5Y69													x	x	x	x	x	x					
3Y89																				x			
4Y89																				x	x		
3Y96																					x		x
4Y96																					x	x	x

Grade notation of welding consumables for semi-automatic welding is supplemented with the letter S; grade notation of consumables for automatic multi-run welding – with the letter M.  
Example: 3Y69S, 3Y69M.

**23.2.2** Where normal strength hull structural steel is to be joined with higher strength hull structural steel, the welding consumables of the lowest grade intended for these steels may be used.

**23.2.3** Where two different steel grades are to be joined, the welding consumables intended for higher or lower strength shall be used.

**23.2.4** Hydrogen-controlled welding consumables (e.g. basic-type electrodes) shall be used for welding the following elements:

- assembly joints between sections,
- all butts and seams of the ice belt of shell plating,
- elements of longitudinal framing,
- butt welds of hull elements more than 20 mm in thickness,
- thick-walled elements (sternframe, stem, etc.),
- butt welds welded in the closed and stiff circumference conditions.

**23.2.5** When joining steel of Grade E, the Grade E steel with steel of other strength level, as well as higher strength and the steel for boilers and pressure vessels, hydrogen-controlled welding consumables shall be used in accordance with Table 24.4.5.

When welding high strength steel, hydrogen-controlled welding consumables shall be used in accordance with Table 24.10.6.

**23.2.6** Tack welds shall be performed only by welders certified by PRS and using the same welding consumables which are required for welding the particular structure. Tack welds shall be free from defects that might impair the quality of the welded joints. At the request of the PRS Surveyor, tack welds shall be examined for cracks or other defects. Any defective tack welds shall be cut out to sound metal and shall be re-welded.

Where tack welds are made by welders not certified by PRS, they shall be cut out immediately before welding.

**23.2.7** Lifting eye plate positions shall be free from cracks and laminations which shall be confirmed by the results of adequate tests, e.g. ultrasonic testing.

**23.2.8** When applied to YP47 steels, short bead length for tack and repairs of welds by welding shall not be less than 50 mm. In the case where  $P_{cm}$  is less than or equal to 0.19, 25 mm of short bead length may be adopted with approval of PRS.

**23.2.9** For YP47 steels, preheating shall be 50°C or over when air temperature is 5°C or below. In the case where  $P_{cm}$  is less than or equal to 0.19 and the air temperature is below 5°C but above 0°C, alternative preheating requirements may be adopted with approval of PRS.

### **23.3 Welding of Machinery**

**23.3.1** The requirements specified in sub-chapter 23.3 apply to welding of the components of machinery made from the parent metal, using consumables which fulfil the requirements specified in the relevant Parts of the *Rules*. Welding of components made from materials other than those specified in the *Rules* shall be agreed with PRS.

**23.3.2** Consumables for welding machinery shall be so selected as to suit the particular steel grades, with due regard paid to the requirements specified in paragraphs 23.2.1, 23.2.2 and 23.2.4, as well as the steel manufacturer's recommendations, particularly in the case of steel other than hull structural steel.

**23.3.3** Where the component parts of machinery are subjected to high service temperature or are in contact with chemically active media, welding consumables shall be selected having regard to these operating conditions.

**23.3.4** When welding component parts of the ship machinery made from steel 30 mm in thickness and over, hydrogen controlled welding consumables shall be used to ensure the resistance of the welded joint to cold cracking. Welding operations shall be so performed as to avoid cold cracking by technological processes (preheating, heat treatment, limitation of the minimum ambient temperature, etc.).

**23.3.5** Welding of propeller shafts and crankshafts shall be agreed with PRS.

**23.3.6** PRS may give consent to the use of welding, build-up welds, metallisation and other methods for repair of ship machinery, provided satisfactory test results are obtained according to the programme agreed with PRS and suitability of the welding method for a given structure is confirmed.

## **23.4 Welding of Boilers and Pressure Vessels**

**23.4.1** Welded seams of boilers and pressure vessels shall be so marked as to enable identification of the welder who performed the weld.

Longitudinal and circumferential welds of headers and drums of boilers and pressure vessels shall be executed as butt welds.

Where butt welds are impracticable, the selected joint method and workmanship technology are subject to PRS acceptance in each particular case.

Longitudinal and circumferential seams of boiler drums shall be made with back sealing run, except cases where the weld joint factor has been taken equal to or less than 0.7.

Single-side butt welding on backing strips forming the weld root is subject to PRS acceptance in each particular case.

Cut-outs and openings in the boiler shell shall be, as far as practicable, so located as not to intercept the longitudinal or circumferential welds of boiler drums nor be tangent thereto. The minimum distance between the hole and weld shall not be less than 3 times the plate thickness, however not less than 50 mm.

The possibility of welding, to the boiler drum, temporary fittings used for assembly, clamps or other fittings is subject to PRS acceptance in each particular case.

**23.4.2** Consumables for the welding of boilers and pressure vessels shall be suitable for the grade of steel to be used in construction, taking into account the requirements specified in paragraphs 23.2.1, 23.2.2 and 23.2.4, as well as the steel manufacturer's recommendations, particularly in the case of steel other than hull structural steel.

**23.4.3** Hydrogen-controlled welding consumables, e.g. basic-type electrodes shall be used for welding Class I boilers and pressure vessels. Other welding consumables may be used for welding Class II and III boilers and pressure vessels if they are made from unalloyed steel and the joint thickness does not exceed 20 mm.

**23.4.4** Heat treatment of boilers and pressure vessels shall be effected in accordance with the relevant standards and the steel manufacturer's recommendations.



Welded joints of elements which, due to size or special construction thereof, cannot be subjected to stress relief heat treatment as a whole may be submitted to this treatment in sections subject to PRS acceptance in each particular case.

Stress relief heat treatment shall consist in uniform heating a sufficiently wide area along the joint over the width approx. 6 times the plate thickness.

**23.4.5** When manufacturing pressure vessels, boilers and heat exchangers of Class I or II, the weld test assemblies shall be made to check the mechanical properties in the case of:

- piece production;
- series production – on the first piece, as well as in the case of novel types of structures or application of new materials and new methods of welding.

PRS may require that the weld test assemblies should also be made for structures of Class III.

**23.4.6** The weld test assemblies shall be so attached to the boiler or pressure vessel that the test assembly is a continuation of the joint of the boiler or pressure vessel. The weld of the test assembly shall be made in the same technological conditions in which the welding of the boiler or pressure vessel is performed.

After non-destructive testing, the following specimens shall be taken from the test assemblies and tested:

- one butt weld transverse tensile test specimen,
- one transverse bend test specimen for root bend test,
- one transverse bend test specimen for face bend test,
- three Charpy V-notch test specimens.

The conditions of cutting out the specimens from the test assemblies and the conditions of testing shall fulfil the requirements specified in sub-chapter 24.3, having regard to the appropriate method and technique of welding.

## **23.5 Welding of Pipelines**

Welding of pipelines shall be performed in accordance with the requirements specified in *Publication 23/P – Prefabrication of Pipelines*.

## **23.6 Welding of Stainless Steels**

When welding stainless steels specified in Chapter 8, the following guidelines shall be observed:

- welding consumables used shall be approved and so selected that the welded joint corrosion resistance corresponds to that of the parent metal and the mechanical properties of the welded joint correspond to those of the welded steels,
- welding shall be performed with a low heat input,
- ferrite content in the weld shall be at a level adequate for the welded steels,
- adequate level of cleanness shall be provided to prevent impurities from getting into the weld and to protect the plate and welded joint from damage and scratch.

## **23.7 Welding of Stainless Steels with other Steels**

When welding stainless steels with other steels, the welding method and welding consumables shall be so selected as to guarantee the weld properties suitable for the weld joint application.

## **23.8 Welding of Clad Steels with Austenitic Stainless Steels**

When welding clad steels, the following guidelines shall be observed:

- welding consumables used shall be approved and so selected that the welded joint corrosion resistance on the side of cladding is similar to that of the cladding,

- welding shall be performed with a low heat input,
- first, unalloyed steels shall be welded using the consumables corresponding to that steel grade (runs 1 – 5, see Fig. 23.8),
- the joint on the side of cladding shall have at least two runs of weld metal. The first run shall be welded with material having higher Cr and Ni content, the second run shall be welded with materials suitable for cladding, as shown in Fig. 23.8.

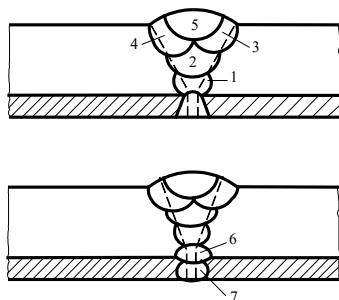

- 1-5 runs – to be welded with electrodes suitable for unalloyed steel
- 6<sup>th</sup> run – to be welded with materials having higher Cr and Ni content
- 7<sup>th</sup> run – to be welded with materials suitable for cladding

Fig. 23.8. Method of welding clad steels

## 23.9 Welding of Steel Forgings and Castings

**23.9.1** Preheating and other technological means shall be provided, whatever the ambient temperature, to ensure the required welding quality in the following cases:

- steel castings or forgings with the carbon content exceeding 0.25%;
- steel castings and forgings with the carbon content exceeding 0.23%, which shall constitute parts of hull structures in ships with ice strengthening notation **L1A**, **L1** or **L2** (castings and forgings of sternframes, stems, propeller shaft brackets, etc.).

**23.9.2** Preheating temperature and heat treatment procedure for castings and forgings shall be determined depending on the design, size and service conditions of the structure concerned, having regard to the requirements specified in paragraphs 23.1.2 and 23.1.10.

**23.9.3** Defects of new castings and forgings may be repaired by welding only where the parent metal has been previously checked for weldability, with due regard paid to the service conditions of the cast or forged part. The repair of defects by welding is subject to PRS acceptance in each particular case.

Repair of defects by welding shall be performed before the final heat treatment. Welding repair of defects after the final heat treatment may be performed only in exceptional cases.

Repetitive defects in castings and forgings shall not be repaired by welding.

**23.9.4** Welding repair of defects in castings shall be made after gating system and riser heads have been removed and the castings have been thoroughly cleaned of sand, scale, inclusions, etc.

The surface to be repaired shall be ground to the sound metal so as to ensure full penetration of the weld.

## 23.10 Welding of Cast Iron

Repair of defects in iron castings by welding is generally not permitted.

In special cases, PRS may give consent to the repair of defects by welding.

### **23.11 Welding of Copper and Copper Alloys**

Welding of copper and copper alloys shall be performed in accordance with the requirements of the relevant standards. Welding repair of cast copper alloy propellers shall be performed in accordance with the requirements specified in *Publication 7P – Repair of Cast Alloy Propellers*.

### **23.12 Welding of Wrought Aluminium Alloys**

**23.12.1** Welding of wrought aluminium alloys, specified in Chapter 18.1, shall be performed using welding methods and welding consumables suitable for the parent metal and ensuring high quality of joints and resistance to corrosion.

**23.12.2** Welded joints shall be arranged, as far as practicable, in the areas with the lowest stress level.

Welding operations shall be performed in the most convenient positions – as far as possible, in the flat position.

Reinforcements of the welds may be removed subject to PRS acceptance in each particular case.

**23.12.3** Before welding (tack welding), the edges of the elements to be welded shall be cleaned using stainless steel wire brushes and then degreased by means of suitable solvents (acetone, alcohol, etc.). The period between cleaning and welding shall be, as far as practicable, short to avoid the cleaned areas from getting dirty. Tack welds shall be also cleaned carefully. In the case of multi-run welding technique, each run of deposit shall be brushed before the next run is applied.

**23.12.4** Welding wire and rods of aluminium alloys shall be degreased and cleaned; the surfaces of wires and rods shall be made free from the layer of oxides, prior to welding.

**23.12.5** For welding aluminium alloys, the use of permanent or temporary backings is permitted. Temporary backings shall be made of stainless steel; permanent backings – of the same alloy as that used for the elements to be welded.

**23.12.6** In the case of two-side welded joint, before a sealing run is applied to the back of the weld, the root of the weld shall be removed, by chipping, machining or plasma cutting, to the sound metal. Cutting out the root by means of grinding is permitted, provided the special abrasive disks, intended for aluminium only, are used.

**23.12.7** Structures made of aluminium alloys may be straightened using oxyacetylene flame. Straightening technology, taking into account the alloy type, straightening method and personnel qualifications shall be agreed with PRS.

**23.12.8** In way of riveted joints of aluminium alloy structures, all essential welding processes shall be completed before riveting.

**23.12.9** Welding of other aluminium alloys shall be agreed with PRS.

### **23.13 Hard Soldering**

Brazed connections of hull structures, specified in paragraph 1.1.1, are subject to PRS survey and shall be executed in accordance with the relevant standards and technical documentation agreed with PRS.

## 24 WELDING CONSUMABLES

### 24.1 General Requirements

**24.1.1** Consumables for welding of the structures which are subject to PRS survey shall be approved by PRS.

**24.1.2** Welding consumables are approved by PRS on the basis of the approval procedure specified in sub-chapter 24.2. Welding consumables, not listed in this sub-chapter, are approved by PRS on the basis of tests performed in accordance with a separate programme which is subject to PRS acceptance in each particular case.

**24.1.3** Consumables for welding normal and higher strength hull structural steel, as well as high strength steel are divided into grades, based on the deposited metal and welded joints mechanical properties. The pattern of welding consumable grade notation is specified in paragraph 24.1.4.

**24.1.4** Welding consumable grade notation consists of one of the numbers: 1, 2, 3, 4, 5, which indicates the required deposited metal and welded joints impact test temperature: 1(+20°C), 2(0°C), 3(-20°C), 4(-40°C), 5(-60°C).

Letter Y, added after the grade number, indicates that the welding consumable is intended for welding higher strength steel or high strength steel.

One of the numbers: 40, 42, 46, 50, 55, 62, 69, 89 or 96, added after the letter Y, indicates the required minimum yield stress of the deposited metal: 40(400 MPa), 42(420 MPa), 46(460 MPa), 50(500 MPa), 55(550 MPa), 62(620 MPa), 69(690 MPa), 89(890 MPa) or 96(960 MPa).

**24.1.5** Grades 1, 2, 3 – indicate that the welding consumable is intended for welding normal strength hull structural steels.

Grades 1Y, 2Y, 3Y, 4Y – indicate that the welding consumable is intended for welding higher strength hull structural steels with  $R_e \leq 355$  MPa. Grade 1Y is applicable to the welding consumables for automatic welding only.

Grades 2Y40, 3Y40, 4Y40, 5Y40 – indicate that the welding consumable is intended for welding higher strength hull structural steels with  $R_e \leq 390$  MPa.

**24.1.6** Grades 3Y42, 4Y42, 5Y42 – indicate that the welding consumable is intended for welding high strength hull structural steels with  $R_e \leq 420$  MPa, grades 3Y50, 4Y50, 5Y50 – indicate that the welding consumable is intended for welding high strength hull structural steels with  $R_e \leq 500$  MPa and similarly: grades 3Y55, 4Y55, 5Y55 – steels with  $R_e \leq 550$  MPa, grades 3Y62, 4Y62, 5Y62 – steels with  $R_e \leq 620$  MPa, grades 3Y69, 4Y69, 5Y69 – steels with  $R_e \leq 690$  MPa, grades 3Y89, 4Y89 – steels with  $R_e \leq 890$  MPa, 3Y96, 4Y96 – steels with  $R_e \leq 960$  MPa.

**24.1.7** Welding consumables for which the hydrogen content has been controlled are identified by mark: H15, H10 or H5 depending on the diffusible hydrogen content in the deposited metal. One of these symbols is added to the grade notation of the consumables with controlled hydrogen content.

**24.1.8** Grade notations of welding consumables for automatic welding are supplemented, depending on welding technique, with the following marks:

- T – for two-run technique where each layer is formed by one run only,
- M – for multi-run technique,
- TM – for two-run and multi-run techniques.

Suffix "S" will be added after the grade notation to indicate approval for semi-automatic welding.

Suffix "V" will be added after the grade notation to indicate approval for electroslag welding and electrogas welding.

**24.1.9** Consumables approved by PRS may be used in such welding positions only for which they have been approved.

**24.1.10** PRS approval is valid only for this welding consumable – coated electrode type, wire-flux combination or wire-shielding gas combination, which has been subjected to approval tests.

**24.1.11** In the case of any change in properties and the chemical composition of an approved welding consumable, the approval tests shall be repeated.

**24.1.12** Upgrading of welding consumables or extension of the approval range may be made at the manufacturer's request, preferably at the time of annual tests, subject to additional tests of test assemblies. The scope of these additional tests shall be agreed with PRS.

**24.1.13** If welding consumables are manufactured in several factories of the same company (with the manufacturer's confirmation that the material used and the manufacturing process are identical with those used in the main works) or are manufactured under licence, the complete approval tests shall be performed in one of the works only. In the remaining factories, these tests may be reduced to annual tests.

## **24.2 Approval Procedure**

### **24.2.1 Technical Documentation**

The technical documentation of the welding consumable submitted to PRS for approval shall include at least the following:

- name of the works – the welding consumable manufacturer,
- proposed grade of the welding consumable according to the *Rules*,
- chemical composition of the deposited metal, guaranteed by the manufacturer,
- mechanical and technological properties of the deposited metal and welded joint, guaranteed by the manufacturer,
- hydrogen content in the deposited metal for hydrogen-controlled welding consumables,
- welding procedure, including particular welding positions,
- short description of welding consumable manufacture technique, manufacture process quality control, as well as the quality control of the welding consumable subjected to approval tests.

### **24.2.2 Works Inspection**

Inspection of the works – the welding consumable manufacturer – shall ascertain that the structure of the works, production methods and quality control ensure uniformity of manufacture.

The inspection of the works applying for approval of welding consumables for the first time shall be conducted prior to approval. On this occasion, PRS Surveyor may select welding consumables which will be subjected to approval tests.

Inspection of the approved works shall be conducted at least once a year, at the time of annual tests.

In special cases, equivalent alternative arrangements may be accepted.

### **24.2.3 Approval Tests**

Approval tests of welding consumable cover the welding of the deposited metal test assemblies and the butt weld test assemblies.

Selection of welding consumables for the preparation of test assemblies, welding, taking the test specimens and the tests shall be performed in the presence of PRS Surveyor or a person duly authorized by PRS. The welding consumables selected for the preparation of tests assemblies shall be manufactured no more than one year prior to the start of welding of test assemblies.

Results of the tests shall fulfil the requirements for the grade of welding consumable requested by the manufacturer at the approval. The results of annual tests shall fulfil the requirements for the particular grade of welding consumable specified in the approval.

#### 24.2.4 Annual Tests

Welding consumables approved by PRS are subject to tests to be performed at least once a year. During the annual tests PRS checks that the manufacturer maintains adequate quality levels at each stages of the manufacture of the approved consumables. Detailed scope of the annual tests is specified in the provisions concerning the conditions for approval of the particular consumables. The tests shall be performed in the presence of PRS Surveyor or a person duly authorized by PRS. The annual tests and their documenting shall be complete before the expiry of the current approval.

Annual tests may – at the manufacturer’s request – be used for approval tests intended to upgrade the existing grade of the tested consumable. In that case, additional test pieces shall be made and tested in accordance with the requirements specified in sub-chapter 24.5.7.

### 24.3 Preparation and Testing of Welding Consumables Test Assemblies

**24.3.1** The deposited metal test assemblies may be prepared from any grade hull structural steel. Depending on the grade of welding consumable, butt weld test assemblies shall be prepared from one of the steel grades specified in Table 24.3.1.

**Table 24.3.1**  
**Steel grades for preparation of test assemblies**

Grade of welding consumable	Grade of steel for test assembly preparation
1	A
2	A, B, D
3	A, B, D, E
IY	AH32, AH36
2Y	AH32, AH36, DH32, DH36
3Y	AH32, AH36, DH32, DH36, EH32, EH36
4Y	AH32, AH36, DH32, DH36, EH32, EH36, FH32, FH36
2Y40	AH40, DH40
3Y40	AH40, DH40, EH40
4Y40	AH40, DH40, EH40, FH40
5Y40	AH40, DH40, EH40, FH40

The dimensions of test assemblies, i.e. the width and length are specified in particular figures. Where the length is not specified, the test assemblies shall be of such length as to allow taking the prescribed number of test specimens.

**24.3.2** Test assemblies shall be prepared under the PRS Surveyor’s supervision. The welding of tests assemblies shall be performed in the PRS Surveyor’s presence. The edges of test assemblies may be beveled by machining or by oxygen cutting. The beveled edges shall be free from any remaining scale or other impurities.

**24.3.3** The welding parameters used, such as amperage, voltage, travel speed, etc., shall be within the range recommended by the manufacturer and shall fulfil the requirements specified in Welding Procedure Specification (WPS) as well as comply with good welding practice. Where a welding consumable is stated to be suitable for both alternating current (AC) and direct current (DC), AC shall be used for the preparation of the test assemblies. PRS may, however, require that the welding tests using direct current shall also be performed.

**24.3.4** Test assemblies shall be welded at ambient temperature and each successive run shall be deposited after the previous run has cooled to at least 250°C, but not less than 100°C. After welding, the test assemblies shall not be subjected to heat treatment.

**24.3.5** Before being cut into test specimens, the butt weld test assemblies shall be submitted to radiographic examination for freedom from inadmissible imperfections.

**24.3.6** Chemical composition of the deposited metal shall be determined.

**24.3.7** The dimensions of specimens for testing the mechanical properties of the deposited metal and butt weld are specified in paragraphs 2.5.6, 2.5.7 and 2.6, 2.7.

**24.3.8** The axis of a deposited metal longitudinal tensile test specimen specified in paragraph 2.5.7 shall coincide with the centre of the weld and the mid-thickness of the plate, as shown in Fig. 24.5.1.

The longitudinal axis of a test specimen taken from butt weld made using a two-run technique shall coincide with the centre of the weld and the mid-thickness of the 2nd run. Prior to testing, the specimens may be heated to a temperature not exceeding 250°C for a period not longer than 16 hours for hydrogen removal.

**24.3.9** The upper and lower surfaces of butt weld transverse tensile test specimen, shown in Fig. 2.5.6, shall be machined flush with the surface of the plate.

**24.3.10** The upper and lower surfaces of butt weld transverse bend test specimen shall be machined flush with the surface of the plate. The sharp corners of the specimen may be rounded to a radius not exceeding 2 mm.

**24.3.11** Charpy V-notch impact test specimen, shown in Fig.2.6.1, shall be cut with its longitudinal axis perpendicular to the weld length. The longitudinal axis of impact test specimens of deposited metal and butt weld made with multi-run technique shall be in the middle of the plate thickness, as shown in Fig. 24.3.11-1. With two-run technique, impact test specimens shall be taken on the 2nd run side, 2 mm below the surface, as shown in Fig. 24.3.11-2. The notch shall be cut in the centerline of the weld and perpendicular to the plate, as shown in Figures 24.3.11-1 and 24.3.11-2.

For electrogas and electroslag welding, additional test specimens with the notch at 2 mm from the fusion line in the deposited metal shall be taken as shown in Fig. 24.8.1.

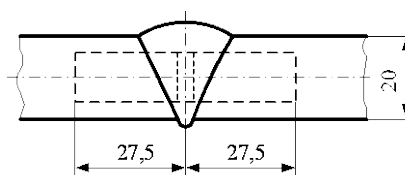

Fig. 24.3.11-1.

The method of preparing Charpy V-notch impact test specimen from butt weld test assembly welded with multi-run technique

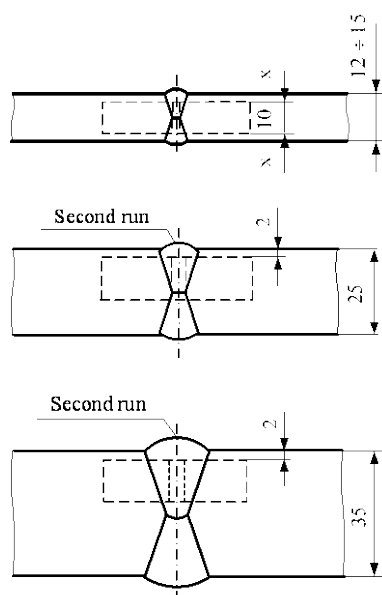

Fig. 24.3.11-2.

The method of preparing Charpy V-notch impact test specimen from butt weld test assembly welded with two-run technique

## 24.4 Assessment of Results of Tests of Welding Consumables for Hull Structure Steels

**24.4.1** At deposited metal tensile test, the values of yield stress, tensile strength and elongation shall be determined. At butt weld tensile test, the values of the butt weld tensile strength and the position of fracture shall be determined.

The required mechanical properties are given in Tables 24.4.4-1 and 24.4.4-2.

**24.4.2** The result of the bend test is considered satisfactory if, after bending the specimen through an angle of 120° over a former having a diameter three times the specimen thickness, no cracks can be seen on the side in tension. Superficial cracks less than 3 mm in length should be ignored.

For each set of bend test specimens, one part of specimens shall be tested with the face of the weld in tension and the other with the root of the weld in tension.

**24.4.3** Impact test shall be performed on 3 specimens. The average absorbed energy value shall fulfil the requirements specified in Tables 24.4.4-1 and 24.4.4-2.

One individual value may be less than the required average value, however it is not less than 70% of this value.

The test temperature for grades 2, 2Y, 2Y40, 3, 3Y, 3Y40, 4Y, 4Y40 and 5Y40 shall be controlled within  $\pm 2^\circ\text{C}$  accuracy.

**24.4.4** Mechanical properties of the deposited metal shall fulfil the requirements specified in Table 24.4.4-1; whereas the mechanical properties of butt weld – shall fulfil the requirements specified in Table 24.4.4-2.



**Table 24.4.4-1**  
**Requirements for mechanical properties of deposited metal**

Grade of welding consumables	Tensile test			Impact test (ISO Charpy V-notch specimen)			
				for deposited metal from electrodes and from semi-automatic welding		for deposited metal from automatic welding	
	$R_m$ [MPa]	$R_e$ [MPa] min.	$A$ [%] min.	Test temperature [°C]	Average energy value from three specimens, [J] min.	Test temperature [°C]	Average energy value from three specimens, [J] min.
1	400÷560	305	22	+20	47	+20	34
2				0	47	0	34
3				-20	47	-20	34
1Y	490÷660	375	22	not subject to classification		+20	34
2Y				0	47	0	34
3Y				-20	47	-20	34
4Y				-40	47	-40	34
2Y40	510÷690	400	22	0	47	0	39
3Y40				-20	47	-20	39
4Y40				-40	47	-40	39
5Y40				-60	47	-40	39

**Table 24.4.4-2**  
**Requirements for mechanical properties of butt weld**

Grade of welding consumables	Tensile test	Bend test	Impact test (ISO Charpy V-notch specimen)				
			for joints welded using electrodes and semi-automatic welding		for joints welded using automatic welding		
	$R_m$ [MPa] min.	Bending angle [degrees] min.	Test temperature [°C]	Welding position		Test temperature [°C]	Average energy value from three specimens [J] min.
				flat, horizontal-vertical, overhead	vertical upward, vertical downward		
1	400	120	+20	47	34	+20	34
2			0	47	34	0	34
3			-20	47	34	-20	34
1Y	490	120	not subject to classification		+20	34	
2Y			0	47	34	0	34
3Y			-20	47	34	-20	34
4Y			-40	47	34	-40	34
2Y40	510	120	0	47	39	0	39
3Y40			-20	47	39	-20	39
4Y40			-40	47	39	-40	39
5Y40			-40	47	39	-40	39

**24.4.5** Hydrogen content in the deposited metal of hydrogen-controlled welding consumables shall not be higher than the values specified in Table 24.4.5. Consumables which fulfil the above requirements are called low-hydrogen welding consumables.

Hydrogen tests are not performed for deposited metal from welding using solid wire with shielding gas.

**Table 24.4.5**  
**Permissible hydrogen content in deposited metal**

Mark of diffusible hydrogen content	Permissible hydrogen content in deposited metal [cm <sup>3</sup> /100 g deposited metal] max.	
	Mercury method Thermal conductivity detector method (ISO 3690)	Glycerine method
H15(H)	15	10
H10(HH)	10	5
H5(HHH)	5	1) <sup>1)</sup>

<sup>1)</sup> Not applicable.

**24.4.6** Where the results of the tensile and bend test do not fulfil the requirements, duplicate test specimens shall be prepared and tested.

The results of re-tests shall fulfil the requirements specified in Tables 24.4.4-1 and 24.4.4-2, respectively.

**24.4.7** Where the results of impact test conducted in accordance with the requirements specified in paragraph 24.4.3 do not fulfil the requirements, an additional set of three impact re-test specimens may be prepared and tested. Re-tests are permitted where not more than two results are below the required average value, and only one of them is below 70% of the required value.

The results obtained shall be combined with the original results to form a new average which, for acceptance, shall not be less than the required value. For these combined results, not more than two individual values shall be less than the required average value, and of these, not more than one shall be less than 70% of the average value.

**24.4.8** Subject to PRS consent, further re-tests may be performed, which shall, however, be done on a new welded test assembly and shall include all tests that were required for the original assembly, even those which were required for the original assembly, even those which were previously satisfactory.

## **24.5 Approval Tests of Covered Electrodes for Manual Arc Welding of Hull Structural Steels**

### **24.5.1 Deposited Metal Tests**

To determine the deposited metal properties, two deposited metal test assemblies shall be prepared in the flat position, one with 4 mm diameter electrode and the other with the largest size manufactured. If an electrode is available in one diameter only, one test assembly is sufficient. The test assemblies shall be as shown in Fig. 24.5.1.

The weld metal shall be deposited in multi-run layers. The direction of deposition of each layer shall alternate from each end of the plate, each run of the weld being not less than 2 mm and not more than 4 mm thick. Welding parameters shall be in accordance with the requirements specified in paragraphs 24.3.3 and 24.3.4.

From each test assembly, the following test specimens shall be taken:

- one longitudinal tensile test specimen of a round section,
- three impact test specimens.

PRS may require that the chemical composition of the deposited metal should be determined.

The tests results shall fulfil the requirements specified in Table 24.4.4-1.

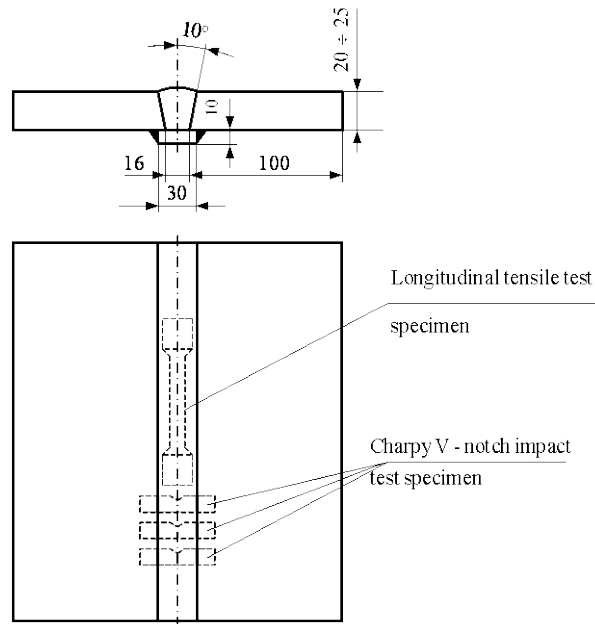

Fig. 24.5.1. Deposited metal test assembly

### 24.5.2 Butt Weld Tests

In order to determine the mechanical properties of butt weld executed in any welding position (flat, horizontal-vertical, vertical or overhead) for which the electrode is recommended by the manufacturer, one test assembly shall be prepared, as shown in Fig. 24.5.2, for each welding position. Electrodes intended for welding in flat and vertical-upward positions may be used for horizontal-vertical position subject to PRS acceptance in each particular case.

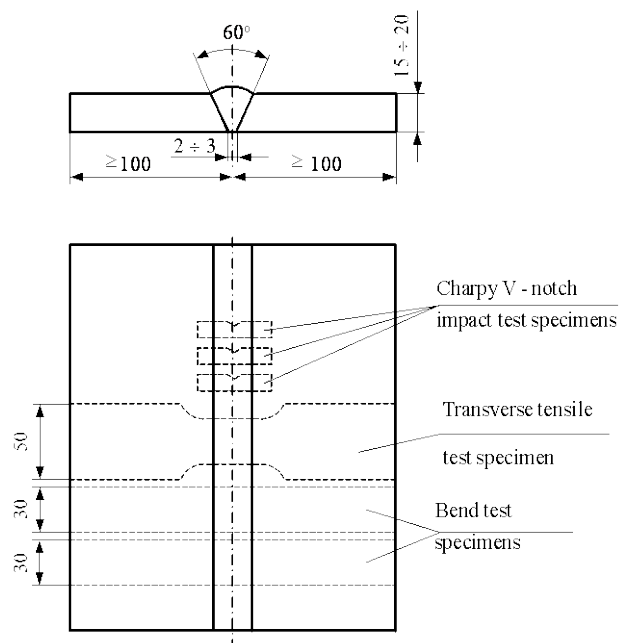

Fig. 24.5.2. Butt weld test assembly welded manually

The following welding procedure shall be adopted in preparing test assemblies:

– *flat position*

The first run shall be welded with 4 mm diameter electrode. The remaining runs – with 5 mm diameter electrodes or above according to the normal welding practice. The runs of the last two layers shall be welded with the largest diameter of electrode manufactured;

– *flat position, the second test assembly* (the second test assembly is required for electrodes intended for welding in the flat position only);

The first run shall be welded with 4 mm diameter electrode. The remaining runs shall be welded with the largest diameter of electrode manufactured;

– *horizontal-vertical position*

The first run shall be welded with 4 mm or 5 mm diameter electrode. Subsequent runs – with 5 mm diameter electrode;

– *vertical-upward and overhead positions*

The first run shall be welded with 3.25 mm diameter electrode. The remaining runs shall be welded with 4 mm diameter electrodes or with 5 mm diameter electrodes in accordance with the normal welding practice or the manufacturer's recommendations;

– *vertical-downward position*

The electrode diameter recommended by the manufacturer shall be used.

The back sealing runs shall be made with 4 mm diameter electrodes in the welding position appropriate to each butt weld test assembly, after cutting out the root run to clean metal. The welding parameters shall be in accordance with the requirements specified in paragraphs 24.3.3 and 24.3.4. After radiographic examinations, the following test specimens shall be taken from each test assembly:

- one transverse tensile test specimen,
- three Charpy V-notch impact test specimens,
- one transverse bend test specimen for face bend test ,
- one transverse bend test specimen for root bend test.

The results of all tests shall fulfil the requirements specified in Table 24.4.4-2.

### 24.5.3 Deposited Metal Hot Cracking Test

PRS may require that the deposited metal hot cracking test should be performed.

For this purpose, three tee joints shall be prepared as shown in Fig. 24.5.3. The welds shall be, as far as practicable, made with electrodes of various diameters.

The lower face of the vertical plate shall be straight and shall fit closely the flat upper surface of the bottom plate.

Tack welds shall be made on the end face of the plate. To prevent distortion, the bottom plate shall be stiffened by three transverse stiffeners.

Both fillet welds shall be made in a single pass in the flat position.

The welding current used shall be the maximum of the range recommended by the manufacturer for the electrode. The second fillet weld shall be laid down immediately after completion of the first fillet weld, starting at the end of the test piece where the first weld terminated. Both fillet welds shall be laid down at a uniform speed, without weaving the electrode.



On the 25 × 125 mm surface of each test specimen, a single bead of welding shall be deposited, about 100 mm in length by a 4 mm electrode, fusing 150 mm of the electrode. The welding shall be performed with an arc as short as possible and with a current of about 150 A. Prior to welding, the electrodes shall be submitted to the normal drying process recommended by the manufacturer. Within 30 seconds of the completion of the welding of each specimen the slag shall be removed and the specimen quenched in water at approximately 20°C. After 30 seconds in water, the specimen shall be cleaned and dried, and then placed in an apparatus suitable for the collection of hydrogen by displacement of glycerine within a further 30 seconds.

During the process of hydrogen emission, the glycerine shall be kept at a temperature of 45°C during the test and the specimens shall be kept immersed in the glycerine for a period of 48 hours and, after removal, they shall be cleaned thoroughly in water and spirit, and then dried by the current of warm air.

After the specimens have cooled down to the ambient temperature, they shall be weighed to the nearest 0.1 g. The amount of gas involved shall be measured to the nearest 0.05 cm<sup>3</sup>, and corrected for temperature and pressure to 0°C and 760 mm Hg.

The content of hydrogen in deposited metal shall be taken as the average value of the test results obtained on four specimens. The average values obtained shall not exceed those specified in Table 24.4.5, and the individual results shall not exceed this value by more than 20%.

#### **24.5.5 Approval Tests of Electrodes Intended for Fillet Welds**

For electrodes intended exclusively for welding fillet welds, the following shall be performed:

- deposited metal test assemblies, in accordance with the requirements specified in paragraph 24.5.1,
- tee joints, as shown in Fig. 24.5.5-1, one for each welding position for which the tested electrodes are intended,
- determining the hydrogen content in the deposited metal for hydrogen-controlled electrodes.

The joints shall be welded in each position for which the electrodes are intended (flat, horizontal-vertical, vertical-upward, vertical-downward, horizontal overhead) using electrodes of the size recommended by the manufacturer for the particular welding position.

The length of the specimen shall ensure the deposition of the weld with the electrode completely fused. The weld on one side of the assembly shall be made with the maximum size of electrode manufactured and on the other – with the minimum size of electrode manufactured. The welding parameters shall be in accordance with the electrode manufacturer's recommendations.

From three test pieces of about 25 mm in width, 3 specimens for macroscopic examination shall be prepared and the hardness of the weld, heat affected zone and parent metal shall be determined by Vickers (HV) method – in accordance with Fig. 24.5.5-1 and Fig. 24.5.5-2.

Hardness of the weld and heat affected zone shall not be greater than 350 HV (under a load of 98 N).

Two test pieces of a tee joint remaining after the preparation of specimens for macroscopic examination shall be subjected to breaking test. From one piece, the first weld shall be removed by arc-gouging or machining and the second weld shall be fractured with the root of the weld in tension. From the second piece, the second weld shall be removed and the first weld shall be subjected to breaking test in the same way as the first piece. The fractures of the welds shall be free from cracks, incomplete fusion or excessive porosity.

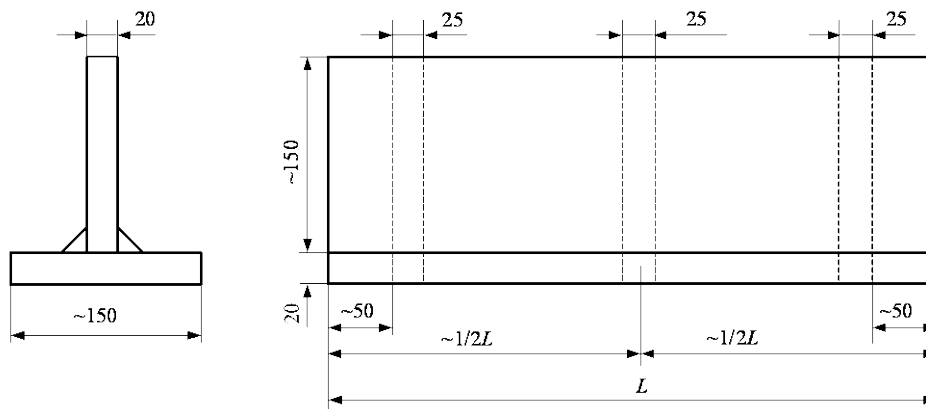

Fig. 24.5.5-1.

Tee joint test assembly for testing electrodes intended for fillet weld

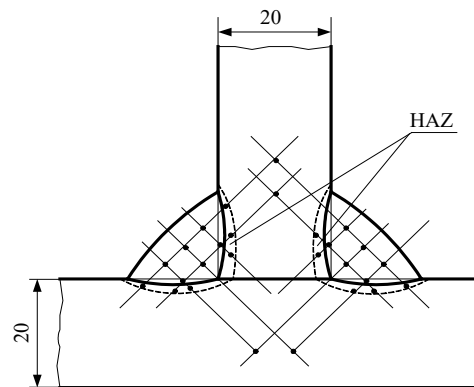

Fig. 24.5.5-2.

Sketch for determining the tee joint hardness

### 24.5.6 Approval Tests of Electrodes for Gravity Welding

In the case of electrodes designed solely for gravity welding, the deposited metal test assembly, as shown in Fig. 24.5.1, and a tee joint, as shown in Fig. 24.5.5-1 shall be prepared.

Welding parameters shall be in accordance with the electrode manufacturer's recommendations. From the test assemblies, specimens shall be taken in accordance with the above-mentioned figures. The results of deposited metal tests shall fulfil the requirements specified in Table 24.4.4-1; the results of tee joints tests shall fulfil the requirements specified in sub-chapter 24.5.5.

Where an electrode has been approved for manual welding and is also recommended for gravity welding, additional tests of tee joints, using gravity welding device, shall be performed.

### 24.5.7 Annual Tests

All approved electrodes are subject to annual tests. The annual test shall involve the following:

- electrodes for manual welding – two deposited metal test assemblies shall be prepared in accordance with Fig. 24.5.1. The welding conditions for test assemblies preparation are specified in sub-chapter 24.5.1; this applies also to electrodes designed solely for fillet welding;
- electrodes designed solely for gravity welding – one deposited metal test assembly shall be prepared in accordance with Fig. 24.5.1. The deposited metal test assembly shall be prepared with a representative electrode according to the normal welding practice.

From the deposited metal test assemblies, specimens shall be taken in accordance with Fig. 24.5.1. The test results shall fulfil the requirements specified in Table 24.4.4-1.

For hydrogen-controlled electrodes marked H5 or H10, PRS may require that the hydrogen content in the deposited metal should be determined.

Where, at the time of annual tests, upgrading of welding consumable, without the change of the approved deposited metal mechanical properties, i.e.  $R_e$ ,  $R_m$ ,  $A$ , is requested by the manufacturer, then, in addition to deposited metal test assemblies, butt weld test assemblies for all welding positions, for which the welding consumable has been approved, shall be prepared. After radiographic examination, 3 impact test specimens shall be taken from each of the test assemblies in accordance with the requirements specified in sub-chapter 24.5.2. The impact test temperature shall correspond to the requested upgrading of the welding consumable.

Where the extension of approval is requested by the manufacturer, i.e. a consumable shall be approved for welding higher strength steels, then, at the approval tests, test assemblies shall be prepared and tested in accordance with the recommendations specified in sub-chapters 24.3, 24.5.1, 24.5.2 or 24.10.

## **24.6 Approval Tests of Welding Consumables for Submerged Arc Welding of Hull Structural Steels**

The present requirements apply to wire-flux combinations for multi-run and two-run automatic welding techniques.

Where particular wire-flux combinations are intended for welding with both techniques, tests shall be performed for each technique.

### **24.6.1 Deposited Metal Test**

To determine the deposited metal properties, one deposited metal test assembly shall be prepared in the flat position as shown in Fig. 24.6.1.

The weld shall be deposited using multi-run technique. The direction of deposition of each run shall alternate from each end of the plate.

Between each run, the assembly shall be left in still air until it has cooled to less than 250°C, but not below 100°C.

The thickness of each layer shall be at least 4 mm, however not less than the diameter of the wire. Welding parameters shall fulfil the requirements specified in sub-chapters 24.3.3 and 24.3.4. The results of tests performed on test specimens taken from the test assembly shall fulfil the requirements specified in Table 24.4.4-1.



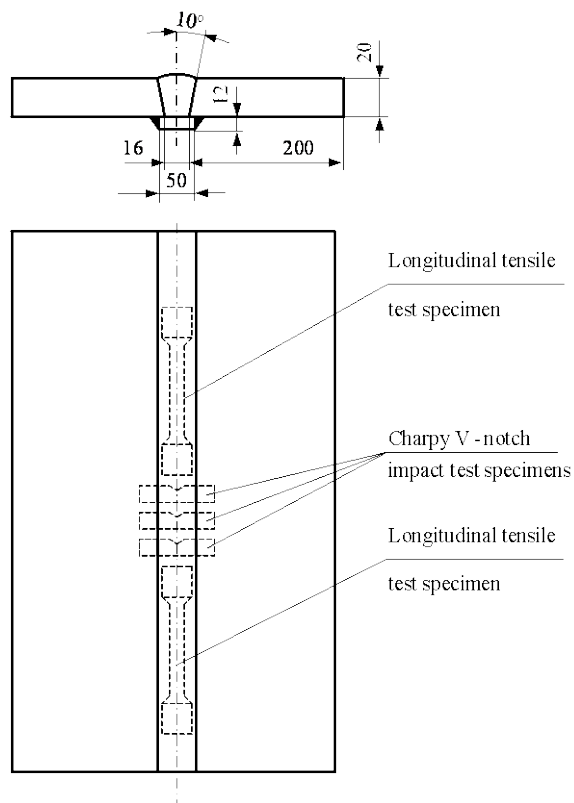

Fig. 24.6.1. Deposited metal test assembly

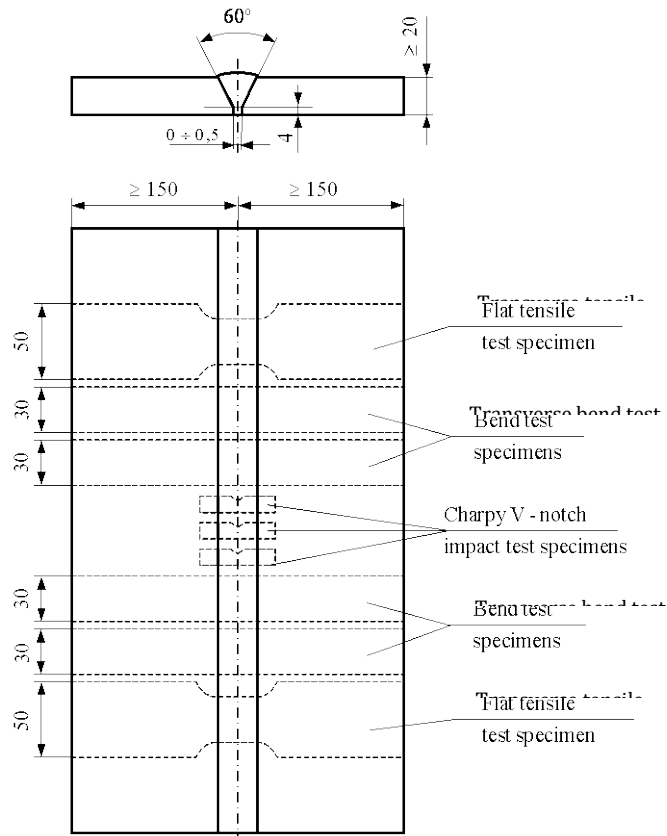

Fig. 24.6.2. Butt weld test assembly welded with multi-run technique

### 24.6.2 Butt Weld Tests for Multi-run Technique

To determine the butt weld properties, one butt weld test assembly shall be prepared in the flat position as shown in Fig. 24.6.2. The welding parameters shall fulfil the requirements specified in sub-chapters 24.3.3 and 24.3.4.

The root run shall be cut out to clean metal and welded.

After radiographic examination, the following test specimens shall be prepared and tested:

- two transverse tensile test specimens,
- three impact test specimens,
- two transverse bend test specimens for face bend test,
- two transverse bend test specimens for root bend test.

The results of tests performed on specimens taken from the test assembly in accordance with Fig. 24.6.2 shall fulfil the requirements specified in Table 24.4.4-2.

### 24.6.3 Butt Weld Tests for Two-run Technique

Where approval for use with two-run technique is requested, butt weld test assemblies shall be prepared in accordance with Fig. 24.6.3:

- for Grades 1 and 1Y – one test assembly 12 to 15 mm in thickness and one test assembly 20÷25 mm in thickness,
- for Grades 2, 2Y, 2Y40, 3, 3Y, 3Y40, 4Y, 4Y40 – one test assembly 20÷25 mm in thickness and one test assembly 30÷35 mm in thickness.

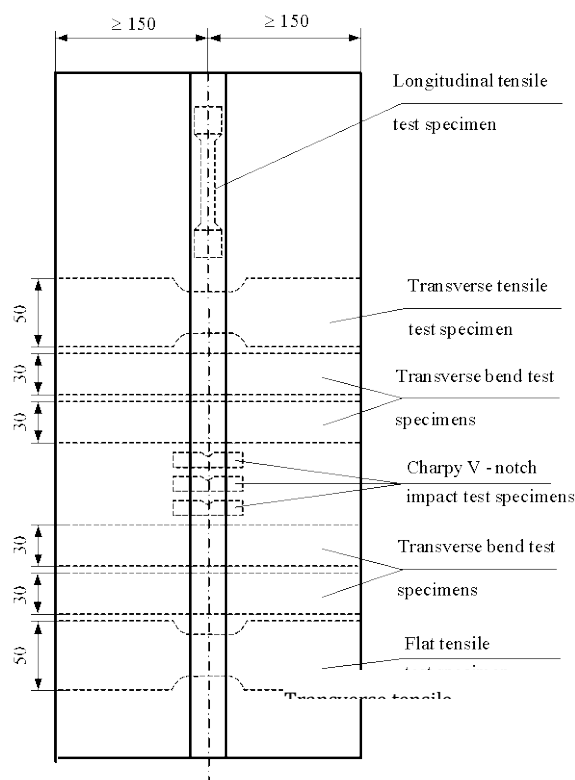

Fig. 24.6.3.

Butt weld test assembly welded with two-run technique

Edge preparation of test assemblies and the wire diameter shall be in accordance with Table 24.6.3.

The root gap shall not exceed 1 mm. Butt weld test assemblies shall be welded in two runs. After completion of the first run and prior to the next run, the test assembly shall be left in still air until it has cooled down to less than 250°C, however not below 100°C. The welding parameters shall be in accordance with the welding consumable manufacturer’s recommendations and normal good welding practice.

After radiographic examination, the following test specimens shall be taken from each test assembly and tested:

- two flat transverse tensile test specimens,
- three impact test specimens,
- two transverse bend test specimens for face bend test,
- two transverse bend test specimens for root bend test.

**Table 24.6.3**  
**Edge preparation of butt weld test assemblies for two-run technique**

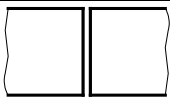
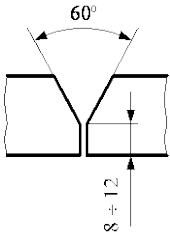
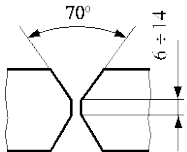
Plate thickness [mm]	Edge preparation	Maximum wire diameter [mm]	Grade of welding consumable
12÷15		5	1
			1Y
20÷25		6	1
			1Y
			2
			2Y
			2Y40
			3
			3Y
			3Y40
			4Y
			4Y40
30÷35		7	2
			2Y
			2Y40
			3
			3Y
			3Y40
			4Y
			4Y40
5Y40			

From each test assembly with the thickness of 20 mm and above, one longitudinal tensile test specimen shall be additionally taken.

The results of the tests performed on a longitudinal tensile test specimen shall fulfil the requirements specified in Table 24.4.4-1; the results of the tests performed on the remaining specimens shall fulfil the requirements specified in Table 24.4.4-2.

#### 24.6.4 Annual Tests

The approved wire/flux combinations are subject to annual tests.

For multi-run technique, only deposited metal test assembly shall be prepared in accordance with Fig. 24.6.1. From the test assembly, the following test specimens shall be taken:

- one longitudinal tensile test specimen,
- three impact test specimens.

For multi-run and two-run techniques, in addition to deposited metal test assembly for multi-run technique, butt weld test assembly with minimum 20 mm thickness plate shall be prepared in accordance with the requirements specified in sub-chapter 24.6.3.

After radiographic examination, the following test specimens shall be taken from the test assembly:

- one transverse tensile test specimen,
- three impact test specimens,
- one transverse bend test specimen for face bend test – the first run,
- one transverse bend test specimen for face bend test – the second run.

For wire-flux combination approved solely for the two-run technique, only butt weld test assembly with minimum 20 mm thickness plate shall be prepared in accordance with the requirements specified in sub-chapter 24.6.3.

After radiographic examination, the following test specimens shall be taken from the test assembly:

- one bend tensile test specimen,
- one flat transverse tensile test specimen,
- three impact test specimens,
- one transverse bend test specimen for face bend test – the first run,
- one transverse bend test specimen for face bend test – the second run.

Where a wire-flux combination is approved for welding both normal strength and higher strength steel using two-run technique, the annual tests shall be performed on test assemblies prepared from higher strength steel.

The results of the tests shall fulfil the requirements specified in Tables 24.4.4-1 and 24.4.4-2.

## 24.7 Approval Tests of Wires without and with Shielding Gas

The requirements specified in this sub-chapter apply to the approval of solid wires and flux-cored wires for use with shielding gas and to the approval of flux-cored wires for use without shielding gas, intended for:

- semi-automatic welding,
- single electrode automatic multi-run welding,
- single electrode automatic two-run welding.

PRS approval is valid only for this wire/shielding gas combination which has been subjected to approval tests.

### 24.7.1 Shielding Gases

Marking and composition of gas types and mixtures are specified in Table 24.7.1.

**Table 24.7.1**  
**Composition of gas types and mixtures**

Group		Gas composition (Vol. %)			
		CO <sub>2</sub>	O <sub>2</sub>	H <sub>2</sub>	Ar <sup>1)</sup>
M1	1	> 0 up to 5	–	> 0 up to 5	remainder
	2	> 0 up to 5	–	–	remainder
	3	–	> 0 up to 3	–	remainder
	4	> 0 up to 5	> 0 up to 3	–	remainder

Group		Gas composition (Vol. %)			
		CO <sub>2</sub>	O <sub>2</sub>	H <sub>2</sub>	Ar <sup>1)</sup>
M2	1	> 5 up to 25	–	–	remainder
	2	–	> 3 up to 10	–	remainder
	3	> 5 up to 25	> 0 up to 8	–	remainder
M3	1	> 25 up to 50	–	–	remainder
	2	–	> 10 up to 15	–	remainder
	3	> 5 up to 50	> 8 up to 15	–	remainder
C	1	100	–	–	–
	2	remainder	> 0 up to 30	–	–

<sup>1)</sup> Argon may be substituted by helium up to 95% of its content.

### 24.7.2 Determining Hydrogen Content in Deposited Metal

Flux-cored wires which have satisfied the requirements for Grades 2, 2Y, 2Y40, 3, 3Y, 3Y40, 4Y, 4Y40 shall be subjected to a hydrogen test.

To determine the hydrogen content in deposited metal, flux-cored wires shall be submitted to tests in accordance with the requirements specified in sub-chapter 24.5.4, using the recommended, by the manufacturer, welding parameters and adjusting the deposition rate to give the weight of weld deposit per specimen similar to that deposited when using electrodes for manual arc welding.

### 24.7.3 Approval Tests of Wires for Semi-Automatic Welding

At approval tests of wires for semi-automatic welding, to determine the deposited metal properties, two deposited metal tests assemblies shall be prepared in the flat position in accordance with Fig. 24.5.1, one using the smallest diameter and the other using the largest diameter of wire intended for the welding of ship structures. Where only one diameter is manufactured, only one deposited metal test assembly shall be prepared. The weld metal shall be deposited according to the practice recommended by the manufacturer and the thickness of each layer of weld metal shall be between 2 and 6 mm.

Chemical analysis of the deposited metal shall be made.

From the deposited metal test assemblies, the following test specimens shall be taken:

- one longitudinal tensile test specimen,
- three impact test specimens.

The results of the tests shall fulfil the requirements specified in Table 24.4.4-1.

To determine the butt weld properties, butt weld test assemblies shall be prepared in accordance with Fig. 24.5.2 for each recommended, by the manufacturer, welding position. The flat assembly shall be welded using, for the first run, the wire of the smallest diameter to be approved and for the remaining runs, the wire of the largest diameter to be approved. The butt weld test assemblies in positions other than the flat shall be welded using, for the remaining runs, the largest diameter of wire recommended by the manufacturer for the position concerned.

Where approval is requested only in the flat position, an additional butt weld test assembly shall be prepared in that position using wire of diameter different from that used for preparing the first assembly.

Where only one diameter is manufactured, only one flat butt weld test assembly shall be prepared.

Welding parameters shall be in accordance with the wire manufacturer's recommendations specified in WPS and normal good welding practice.

After radiographic examination, the following test specimens shall be taken from test assemblies:

- one transverse tensile test specimen,
- three impact test specimens,
- one transverse bend test specimen for face bend test,
- one transverse bend test specimen for root bend test .

The results of the tests shall fulfil the requirements specified in Table 24.4.4-2. Wires intended exclusively for welding fillet welds shall be tested in accordance with the requirements specified in sub-chapter 24.5.5.

#### 24.7.4 Approval Tests of Wires for Automatic Multi-Run Welding

Solid wires and flux-cored wires for use with shielding gas, as well as flux-cored wires for use without shielding gas approved for multi-run semi-automatic welding may be also accepted, without additional tests, for use in multi-run automatic welding.

Approval tests of wires for automatic multi-run welding shall be performed in accordance with the below mentioned recommendations.

To determine the deposited metal properties, one deposited metal test assembly shall be prepared in the flat position as shown in Fig. 24.6.1. The diameter of the wire shall be in accordance with the welding practice with the wires. The welding parameters shall be in accordance with the recommendations of the welding consumables' manufacturer and good welding practice. The thickness of each layer shall be not less than 3 mm.

Chemical analysis of the deposited metal shall be made. From the prepared deposited metal test assembly, specimens shall be taken as shown in Fig. 24.6.1. The results of the tests shall fulfil the requirements specified in Table 24.4.4-1.

To determine the butt weld properties, butt weld test assembly shall be prepared in the flat position according to Fig. 24.6.2. The welding conditions shall fulfil the requirements specified in sub-chapters 24.3.3 and 24.3.4.

From the prepared test assemblies, specimens shall be taken as shown in Fig. 24.6.2. The results of the tests shall fulfil the requirements specified in Table 24.4.4-2.

#### 24.7.5 Approval Tests of Wires for Automatic Two-Run Welding

Approval tests of wires for automatic two-run welding shall be performed in accordance with the requirements specified in sub-chapter 24.6.3, having regard to the following recommendations:

- irrespective of the approval grade, two butt weld test assemblies shall be prepared, using plates of  $12 \pm 15$  mm and  $20 \pm 25$  mm in thickness. The plates shall be welded as shown in Fig. 24.7.5;

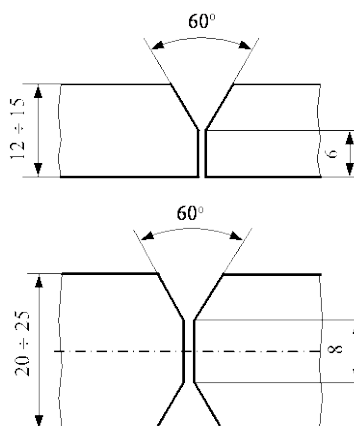

Fig. 24.7.5. Two-run butt weld test assemblies

- where approval is requested for welding plate thicker than 25 mm, two butt weld test assemblies shall also be prepared – one assembly shall be prepared using plates approximately 20 mm in thickness and the other using plates of the maximum thickness for which approval is requested. The beveling of the plate thicker than 25 mm, as well as the wire diameter and the welding parameters shall be in accordance with the wire manufacturer’s recommendations.

From the prepared test assemblies, specimens shall be taken as shown in Fig. 24.6.3. The results of the tests shall fulfil the requirements specified in Tables 24.4.4-1 and 24.4.4-2.

#### **24.7.6 Annual Tests**

The approved solid wires and flux-cored wires for use with shielding gas, as well as flux-cored wires for use without shielding gas are subject to annual tests.

Within the scope of the tests, the following shall be performed:

- for wires approved for semi-automatic welding, the deposited metal test assembly shall be prepared in accordance with the requirements specified in sub-chapter 24.7.3, using one of approved diameter wires,
- for wires approved for automatic multi-run welding, the deposited metal test assembly shall be prepared in accordance with the requirements specified in sub-chapter 24.7.4,
- for wires approved for automatic two-run welding, the butt weld test assembly shall be prepared in accordance with the requirements specified in sub-chapter 24.7.5, using plate 20 ÷ 25 mm in thickness.

The diameters of wires used shall be stated in the test report.

From the deposited metal test assemblies – multi-run semi-automatic and automatic welding – the following test specimens shall be taken:

- one longitudinal tensile test specimen,
- three impact test specimens.

From the butt weld test assembly – two-run automatic welding – after radiographic examination, the following test specimens shall be taken:

- one transverse tensile test specimen,
- three impact test specimens,
- one transverse bend test specimen for face bend test – the first run,
- one transverse bend test specimen for face bend test – the second run,
- one longitudinal tensile test specimen when the wire is approved solely for automatic two-run welding.

For flux-cored wires PRS may require that a hydrogen test should be performed at annual tests.

### **24.8 Approval Tests of Consumables for Use in Electroslag and Electrode Gas Welding**

#### **24.8.1 Test Assemblies’ Testing**

Approval tests of consumables for electroslag and electrode gas welding shall be performed in accordance with the below mentioned recommendations.

Two butt weld test assemblies shall be prepared as shown in Fig. 24.8.1, one of them using plates 20 ÷ 25 mm thick, the other using plates 35 ÷ 40 mm thick or more. The grade of steel to be used for the assemblies shall be selected in accordance with Table 24.3.1. For consumables intended for welding higher strength tensile steel, a niobium treated steel shall be used for the approval tests.

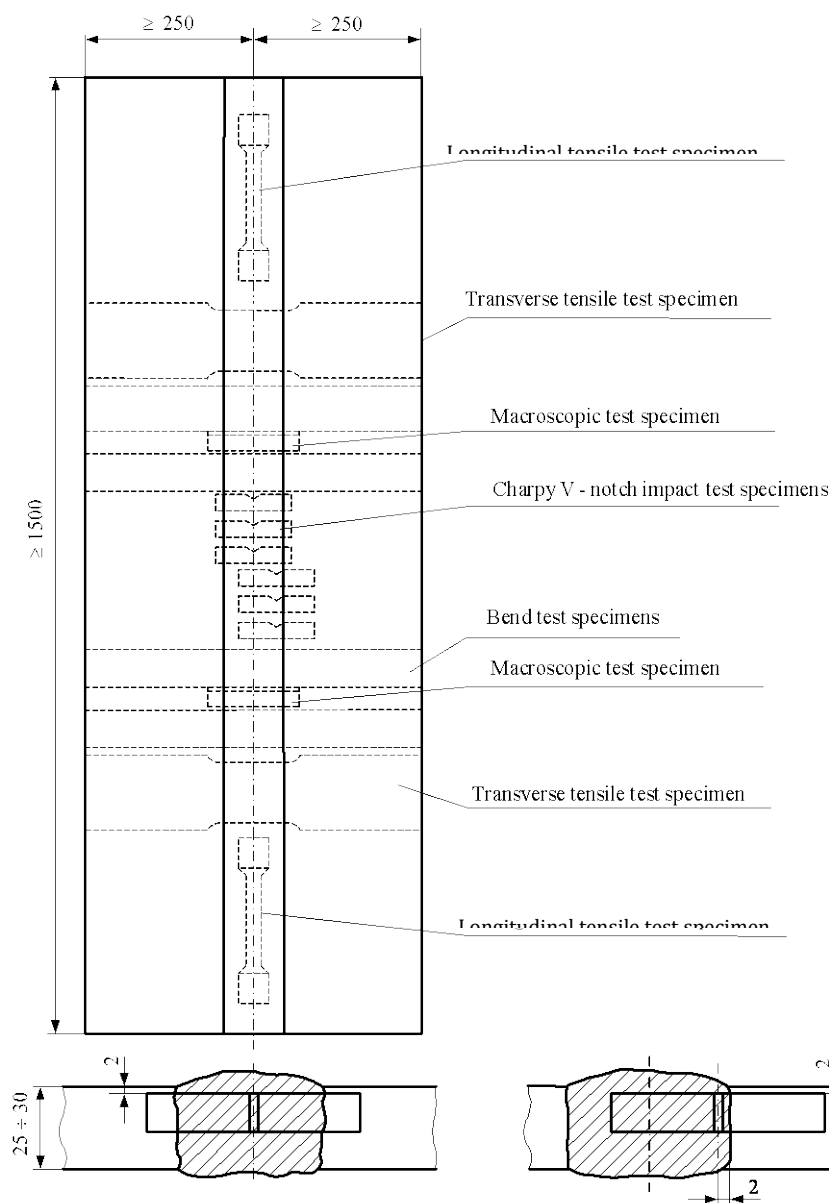

Fig. 24.8.1. Electroslag and electrogas butt weld test assembly

The edge preparation, gap and welding conditions shall fulfil the recommendations specified by the welding consumables manufacturer.

From the prepared butt weld test assemblies subjected to radiographic examination, specimens shall be taken as shown in Fig. 24.8.1. From each of the test assemblies the following specimens shall be taken:

- two longitudinal tensile test specimens,
- two transverse tensile test specimens,
- two transverse bend test specimens,
- two side bend test specimens
- two sets of Charpy V-notch test specimens consisting of three items each; in one set the specimens with the notches in the centreline of the weld whereas in the other set, the specimens with their notches at 2 mm from fusion line, in the weld,
- two macroscopic test specimens.



The results of the tests performed on the longitudinal tensile test specimens shall fulfil the requirements specified in Table 24.4.4-1, whereas for the remaining specimens – the requirements specified in Table 24.4.4-2.

### 24.8.2 Annual Tests

Approved welding consumables for use in electroslag and electrogas welding are subject to annual tests.

Within the scope of the tests, one butt weld test assembly using plates 20÷25 mm in thickness shall be prepared in accordance with Fig. 24.8.1.

From the prepared butt weld test assembly subjected to radiographic examination, test specimens shall be taken in accordance with Fig. 24.8.1. The results of the tests performed on round tensile test specimens shall fulfil the requirements specified in Table 24.4.4-1. The results of the tests performed on the remaining specimens shall fulfil the requirements specified in Table 24.4.4-2.

### 24.9 Approval Tests of Consumables for One Side Welding on Backing Strips

**24.9.1** Approval tests of consumables for one side welding on backing strips shall be performed in accordance with the requirements specified in sub-chapters 24.5, 24.6 and 24.7 for appropriate welding method, having regard to the recommendations specified below.

The deposited metal test assembly shall be prepared in accordance with Fig. 24.5.1 or Fig. 24.6.1, depending on the welding method.

To determine the properties of a butt weld, a test assembly shall be prepared using plates of 20-25 mm in thickness for each welding position recommended by the manufacturer, see Fig. 24.9.

For high heat input welding processes where the minimum thickness of individual layers exceeds 6 mm, the second test assembly shall be made of 35–40 mm in thickness. In addition to the test specimens indicated in Fig. 24.9, one set of three Charpy V-notch impact test specimens shall be prepared; the specimens shall have their longitudinal axes at the plate mid-thickness, and the notch shall be situated in the middle of the weld as shown in Fig. 24.3.11-1.

The edge preparation, gap and welding conditions shall fulfil the recommendations specified by the welding consumables manufacturer.

Mechanical properties of deposited metal shall fulfil the requirements specified in Table 24.4.4-1; the mechanical properties of the butt weld shall fulfil the requirements specified in Table 24.4.4-2, for the appropriate grades of welding consumables.

Where welding consumables have been approved by PRS for welding without backings, only butt weld test assembly shall be prepared in accordance with Fig. 24.9.

### 24.10 Approval Tests of Welding Consumables for High Strength Steels

**24.10.1** Welding consumables for high strength steel shall be tested in accordance with the requirements specified in sub-chapters 24.5, 24.6 and 24.7. Approval of welding consumables for automatic welding is subject to special consideration by PRS.

Test assemblies shall be prepared from high strength steel; for the tests, the steel grade shall be selected in accordance with Table 24.10.1.

The deposited metal test assemblies may be prepared from other grade steel, provided that the side walls of the weld, before assembling, are buttered with the welding consumable subjected to approval.

Welding parameters shall be in accordance with the welding consumables and steel manufacturers' recommendations.

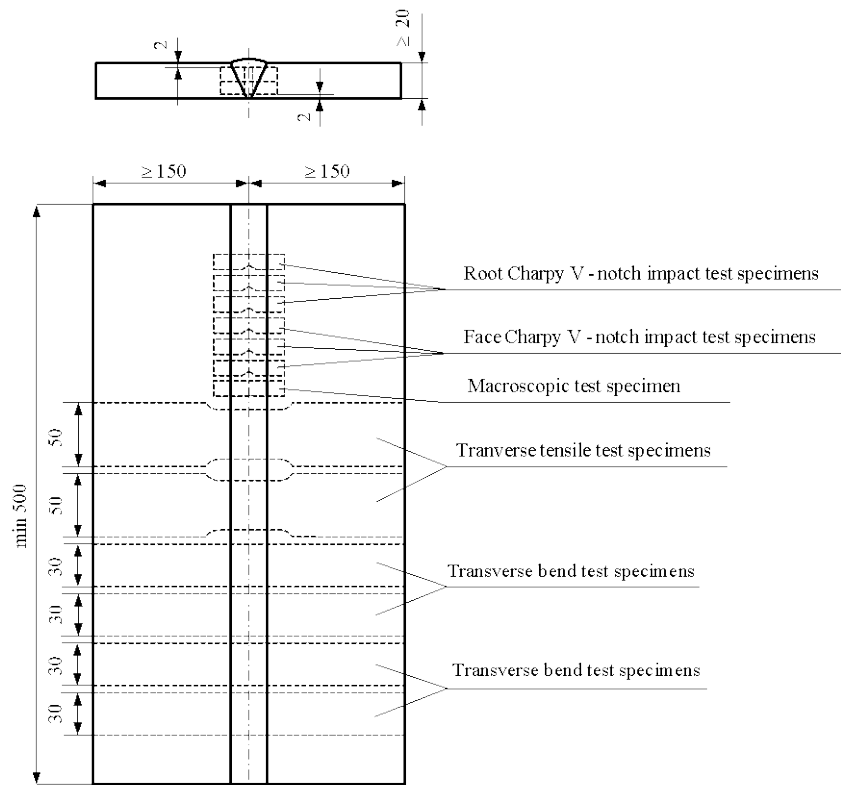

Fig. 24.9. Butt weld test assembly made on backings

**Table 24.10.1**  
**Steel requirements for the approval tests of welding consumables for high strength steel**

Grade of welding consumables	Grade of high strength steel
3Y42	A420, D420
4Y42	A420, D420, E420
5Y42	A420, D420, E420, F420
3Y46	A460, D460
4Y46	A460, D460, E460
5Y46	A460, D460, E460, F460
3Y50	A500, D500
4Y50	A500, D500, E500,
5Y50	A500, D500, E500, F500
3Y55	A550, D550
4Y55	A550, D550, E550
5Y55	A550, D550, E550, F550
3Y62	A620, D620
4Y62	A620, D620, E620
5Y62	A620, D620, E620, F620
3Y69	A690, D690
4Y69	A690, D690, E690
5Y69	A690, D690, E690, F690
3Y89	A890, D890
4Y89	A890, D890, E890
3Y96	A960, D960
4Y96	A960, D960, E960

**24.10.2** Mechanical properties of deposited metal, obtained from consumables, shall fulfil the requirements specified in Table 24.10.2.

**Table 24.10.2**  
**Requirements for mechanical properties of deposited metal**

Grade of welding consumable	Tensile strength test			Charpy V-notch impact test	
	$R_e$ [MPa] min.	$R_m$ [MPa]	$A_5$ [%] min.	Test temperature [°C]	Average value from three specimens, [J] min. <sup>1)</sup>
3Y42 4Y42 5Y42	420	520 ÷ 680	20	-20 -40 -60	47
3Y46 4Y46 5Y46	460	540 ÷ 720	20	-20 -40 -60	47
3Y50 4Y50 5Y50	500	590 ÷ 770	18	-20 -40 -60	50
3Y55 4Y55 5Y55	550	640 ÷ 820	18	-20 -40 -60	55
3Y62 4Y62 5Y62	620	700 ÷ 890	18	-20 -40 -60	62
3Y69 4Y69 5Y69	690	770 ÷ 940	17	-20 -40 -60	69
3Y89 4Y89	890	940 ÷ 1100	14	-20 -40	69
3Y96 4Y96	960	980 ÷ 1150	13	-20 -40	69

<sup>1)</sup> For the requirements regarding minimum individual values of impact energy and re-tests, see paragraphs 24.4.3 and 24.4.7.

**24.10.3** Mechanical properties of welded joints shall fulfil the requirements specified in Table 24.10.3.

**Table 24.10.3**  
**Requirements for mechanical properties of welded joint**

Grade of welding consumable	Tensile strength $R_m$ [MPa] min.	Charpy V-notch impact test		Bending	
		Test temperature [°C]	Average value from three specimens [J] min.	Bending angle [degrees] <sup>1)</sup>	Bend ratio $D/t$ <sup>2)</sup>
3Y42 4Y42 5Y42	520	-20 -40 -60	47	120	4
3Y46 4Y46 5Y46	540	-20 -40 -60	47	120	4
3Y50 4Y50 5Y50	590	-20 -40 -60	50	120	4

Grade of welding consumable	Tensile strength $R_m$ [MPa] min.	Charpy V-notch impact test		Bending	
		Test temperature [°C]	Average value from three specimens [J] min.	Bending angle [degrees] <sup>1)</sup>	Bend ratio $D/t$ <sup>2)</sup>
3Y55 4Y55 5Y55	640	-20 -40 -60	55	120	5
3Y62 4Y62 5Y62	700	-20 -40 -60	62	120	5
3Y69 4Y69 5Y69	770	-20 -40 -60	69	120	5
3Y89 4Y89	890	-20 -40	69	120	6
3Y96 4Y96	960	-20 -40	69	120	7

1) Bending angle attained before the first incipient cracks; minor cracks up to max. 3 mm are disregarded.

2)  $D$  – former diameter,  $t$  – specimen thickness.

**24.10.4** If, during the bend test, the bending angle specified in Table 24.10.3 has not been attained, the test may be considered satisfactory if the gauge length  $L_0$  relative elongation (Fig. 24.10.4) fulfils the requirements specified in Table 24.10.2.

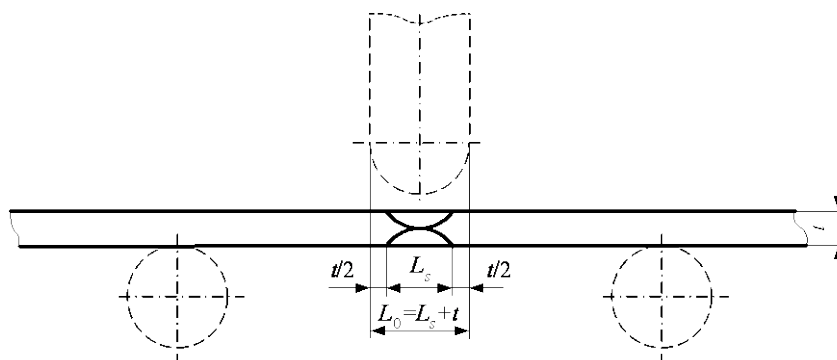

Fig. 24.10.4. Bend test dimensions

**24.10.5** Consumables for welding high strength steel, other than solid wire-gas combinations, shall be subjected to a hydrogen test. The hydrogen content in deposited metal shall be determined by the mercury method or any other method, such as the gas chromatographic method which correlates with the mercury method in respect of cooling rate, the preparation time of the weld samples and the hydrogen content determination.

**24.10.6** The permissible hydrogen content in the deposited metal for particular grades of consumables intended for welding high strength steel is specified in Table 24.10.6.

**Table 24.10.6**  
**Permissible hydrogen content in deposited metal from welding consumables**  
**for welding high strength steels**

Grade of welding consumables	Hydrogen symbol	Hydrogen content in deposited metal [cm <sup>3</sup> /100 g] deposited weld metal max.
3, 4, 5Y42 3, 4, 5Y46 3, 4, 5Y50	H10	10
3, 4, 5Y55 3, 4, 5Y62 3, 4, 5Y69 3, 4Y89 3, 4Y96	H5	5

### 24.10.7 Annual Tests

Approved welding consumables for welding high strength steels are subject to annual tests.

The tests shall include deposited metal test, in accordance with Fig. 24.5.1 or Fig. 24.6.1, depending on welding consumables.

The scope of the tests shall be as required for annual tests in accordance with the requirements specified in paragraphs 24.5.7, 24.6.4, 24.7.6, depending on welding consumable.

For grades 3Y89, 4Y89, 3Y96 and 4Y96 annual hydrogen test is required.

In special cases, PRS may require additional tests, e.g. welded joints tests, to be performed.

### 24.11 Approval Tests of Welding Consumables for Boiler Steels

Approval tests of consumables for welding boiler steels shall be performed in accordance with the requirements specified in sub-chapters 24.5 to 24.7, taking account of the following recommendations:

- test assemblies shall be prepared from the boiler steel for which the welding consumables are intended;
- from deposited metal and butt weld test assemblies, three additional Charpy V-notch specimens shall be taken for impact test after ageing (ageing conditions – 5% plastic strain and annealing at temperature of 250°C during 1 hour). The test conditions and requirements are subject to PRS acceptance in each particular case;
- when testing welding consumables for boiler steels operating at a temperature exceeding 350°C, PRS may require performing the tensile test at the maximum working temperature, with determination of the proof stress  $R_{0.2}$ . The tests and the tests results assessment shall be agreed with PRS.

### 24.12 Approval Tests of Welding Consumables for Machinery, Equipment and Piping Steels

Welding consumables approved for hull structural and boiler steels may be also approved, without additional testing, for steels intended for the manufacture of machinery, equipment and piping, provided they are made of steel similar to hull structural steel or having similar properties.

In all other cases, the welding consumables shall be tested in connection with steels for which they are intended.

The tests shall be performed in accordance with a programme agreed with PRS.

### 24.13 Approval Tests of Welding Consumables for Stainless and Clad Steels

**24.13.1** Approval tests of consumables for welding stainless steels, described in Chapter 8, shall be performed in accordance with the requirements specified in sub-chapters 24.5, 24.6 and 24.7. Test assemblies shall be made from steel for which approval of the consumables is requested. The deposited metal test assemblies may be prepared from other grade steel, provided that the side walls of the weld, before assembling, are buttered with the welding consumable, subjected to approval.

The deposited metal tests results shall comply with the properties guaranteed by the manufacturer; the butt weld tests results – with the minimum specified properties of steel for which they are intended.

**24.13.2** In order to determine the properties of butt weld made of clad steel, two test assemblies shall be prepared as shown in Fig. 24.13.2-1 in accordance with the welding procedure specification agreed with PRS: one assembly shall be prepared from the material of a minimum thickness, the other from the material of a maximum thickness for which the tested welding consumables are intended. From the prepared test assemblies, specimens shall be taken as shown in Fig. 24.13.2-1. From bend test specimen, the surplus of the weld shall be removed, not more, however, than to the level of the cladding. The measurement of hardness shall be performed as shown in Fig. 24.13.2-2.

In the case of two-side clad steel plates, for transverse bend test, a double number of specimens shall be cut from the test assembly. The bend test shall be performed with the clad layer in tension. The measurement of hardness shall be performed as shown in Fig. 24.13.2-2.

For the welds where the plate is two-side clad, the measurement of hardness shall be performed on both sides.

The hardness shall be measured by Vickers method (under the load of 98 N). The bend test results shall fulfil the requirements specified in paragraph 24.4.2. The hardness measurement results shall be submitted to PRS for acceptance in each particular case.

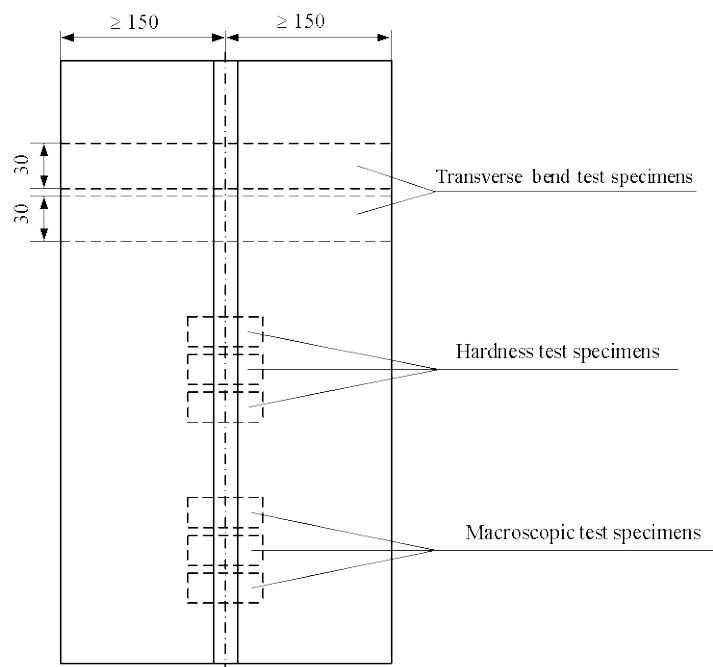

Fig. 24.13.2-1. Butt weld test assembly

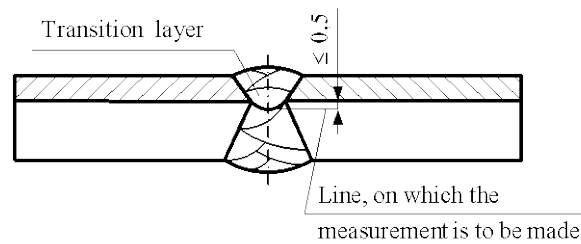

Fig. 24.13.2-2. Butt weld hardness test specimen

#### 24.14 Approval Tests of Welding Consumables for Copper, Heavy Metals and other non-Ferrous Metals

Consumable intended for welding the particular parent metal shall be tested on the material concerned.

The tests shall be performed in accordance with a programme agreed with PRS.

#### 24.15 Approval Tests of Welding Consumables for Aluminium Alloys

**24.15.1** The requirements specified in sub-chapter 24.15 apply to the approval of welding consumables (wires or rods) intended for welding, with shielding gas, of wrought aluminium alloys specified in sub-chapter 18.1.

Consumables recommended for welding wrought aluminium alloys are divided into two types:

- solid rods intended for tungsten inert gas arc welding – TIG welding,
- solid wires intended for semi-automatic or automatic metal-arc inert gas welding – MIG welding or automatic TIG welding.

**24.15.2** The grade notation of welding consumables intended for welding wrought aluminium alloys consists of two capital letters.

The first letter indicates the type of welding consumables:

- R – solid rod,
- W – solid wire.

The second letter indicates the welding consumable application, depending on the grade of alloy used for tests assemblies' preparation:

- A – 5754
- B – 5086
- C – 5083, 5383, 5456, 5059
- D – 6005A, 6061, 6082.

Welding consumables approved on higher strength AlMg grades may also be used for lower tensile strength AlMg grades and their combination with AlSi grades.

**24.15.3** Aluminium alloy grades for the test assemblies intended for approval tests of particular grades of welding consumables shall be selected in accordance with Table 24.15.3-1.

**Table 24.15.3-1**  
**Aluminium alloy requirements for approval tests of welding consumables**

Consumable quality grade	Aluminium alloy grades	
	Alloy designation	
	Numerical	Chemical symbol
RA/WA	5754	AlMg3
RB/WB	5086	AlMg4
RC/WC	5083	AlMg4.5Mn0.7
	5383	AlMg4.5Mn0.9
	5456	AlMg5
	5059	-
RD/WD	6005A	AlSiMg(A)
	6061	AlMg1SiCu
	6082	AlSi1MgMn

Approval of a wire or rod will be granted in conjunction with a shielding gas – specified in accordance with Table 24.15.3-2 – used for the approval tests.

Composition of the shielding gas shall be given in the test report.

**Table 24.15.3-2**  
**Composition of shielding gases and mixtures for welding aluminium alloys**

Gas designation	Gas composition (Vol. %)	
	Argon (Ar)	Helium (He)
I – 1	100	-
I – 2	-	100
I – 3	Rest	0 to 33
I – 4	Rest	33 to 66
I – 5	Rest	66 to 95
S	Special composition gas <sup>1)</sup>	

<sup>1)</sup> Gases of other chemical composition (mixed gases) may be considered as “special gases” and covered by separate tests subject to PRS acceptance in each particular case.

**24.15.4** To determine the chemical composition of deposited metal, one test assembly, as shown in Fig 24.15.4, shall be prepared. The test assembly dimensions, dependent on the grade of welding consumable and the welding process, shall give a sufficient amount of pure weld metal for chemical analysis.

Chemical composition of the parent metal shall be compatible with the weld metal.

Chemical composition of the deposited metal shall be determined by the manufacturer and stated on the material certificate.

The results of the analysis shall not exceed the limit values specified by the manufacturer.

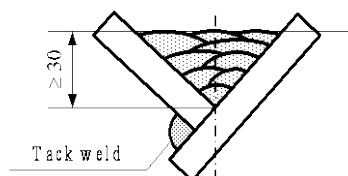

Fig. 24.15.4. Deposited metal test assembly



**24.15.5** Testing of welded joints shall be performed on butt-weld test assemblies prepared from base materials specified in Table 24.15.3-1, in accordance with the manufacturer’s recommendations.

Butt-weld test assemblies with a thickness of 10÷12 mm shall be prepared for each welding position (flat, horizontal-vertical, vertical-upward and overhead) recommended by the welding consumable manufacturer.

Consumables approved for flat and vertical-upward positions may also be used for the horizontal-vertical position subject to PRS acceptance in each particular case.

Additionally, one test assembly with a thickness of 20÷25 mm shall be welded in the flat position only.

The minimum dimensions of test assemblies are 350 × 350 mm. The edge preparation, gap and welding parameters shall fulfil the recommendations specified by the tested welding consumables manufacturer. On completion of welding, test assemblies shall be allowed to cool naturally to ambient temperature.

Welded test assemblies and test specimens shall not be subjected to any heat treatment. Prior to tests, Grade D test assemblies shall be subjected to natural ageing for a minimum of 72 hours from the completion of welding.

After test assemblies’ radiographic examination, the following test specimens shall be taken:

- two transverse tensile test specimens,
- one macroscopic test specimen,
- two transverse bend test specimens for face bend test,
- two transverse bend test specimens for root bend test.

The dimensions of transverse tensile test specimens shall be in accordance with Fig. 2.5.6, whereas the dimensions of bend test specimens – in accordance with Fig. 2.7.4.

**24.15.6** Mechanical properties of butt welds shall fulfil the requirements specified in Table 24.15.6.

The position of the specimen fracture shall be indicated in the test report.

**Table 24.15.6**  
**Requirements for mechanical properties of butt weld**

Consumable grade	Base material used for test	Tensile strength $R_m$ [MPa] min.	Bend test <sup>1)</sup>	
			Former diameter	Bending angle min.
RA/WA	5754	190	3t	180°
RB/WB	5086	240	6t	
RC/WC	5083	275	6t	
	5383 or 5456	290	6t	
	5059	330	6t	
RD/WD	6061, 6005A or 6082	170	6t	

t specimen thickness

<sup>1)</sup> During the test, the test specimen shall not reveal a single flaw greater than 3 mm (in any direction). Flaws appearing at the corners of a test specimen shall be ignored in the evaluation, unless there is evidence that they result from lack of fusion.

Macroscopic tests are performed to detect such imperfections as: lack of fusion, cavities, inclusions, pores or cracks.

**24.15.7 Annual tests cover:**

- preparation of deposited metal test assembly in accordance with the requirements specified in paragraph 24.15.4,
- preparation of one flat butt weld test assembly with a thickness of 10÷12 mm; the test specimens shall be taken in accordance with the requirements specified in paragraph 24.15.5.

**24.16 Approval Tests of Welding Consumables for YP47 steels**

**24.16.1** The requirements specified in 24.1 ÷ 24.10 apply unless otherwise specified in this sub-chapter.

**24.16.2** Mechanical properties of deposited metal and welded joint of welding consumables for YP47 steels shall be in accordance with Tables 24.16.2-1 and 24.16.2-2.

**Table 24.16.2-1  
Requirements for mechanical properties of deposited metal**

Tensile strength test			Charpy V-notch impact test	
$R_e$ [MPa] min.	$R_m$ [MPa]	$A_5$ [%] min.	Test temperature [°C]	Average value from three specimens, [J] min. <sup>1)</sup>
460	570 ÷ 720	19	-20	64

**Table 24.16.2-2  
Requirements for mechanical properties of welded joint**

Tensile strength $R_m$ [MPa]	Charpy V-notch impact test		Bending	
	Test temperature [°C]	Average value from three specimens [J] min.	Bending angle [degrees] <sup>1)</sup>	Bend ratio $D/t$ <sup>2)</sup>
570 ÷ 720	-20	64	20	4

**24.16.3** Special care shall be paid to the final welding so that harmful defects do not remain.

Jig mountings shall be completely removed with no defects in general, otherwise the treatment of the mounting shall be accepted by PRS.

## 25 WELDED STRUCTURE MANUFACTURERS

### 25.1 General Requirements

**25.1.1** Manufacturers, including their all plants and subcontractors, using welding processes for construction and repair of the structures which are subject to technical survey by PRS shall have valid approval by PRS to the welding in the scope covering the work performed.

**25.1.2** Manufacturer requesting an approval shall specify in detail the scope of the requested approval. The requesting manufacturer shall specify the welding processes to be approved and the scope of approval for each of those processes, indicating the following:

- groups and grades of base materials intended to be welded using the particular welding process including the type of product (plates, tubes),
- dimension ranges for parent metals, i.e. ranges of thickness for plates and diameters and ranges of wall thicknesses for tubes,
- weld types (butt, fillet),
- weld details for butt welds and fillet welds,
- welding positions.

**25.1.3** Within the approval procedure, the manufacturer shall demonstrate and document that – in the requested scope of approval – their organization, personnel, equipment, welding processes used in the fabrication conditions, supervision of the processes of construction or repair of the welded structures as well as their final control ensure reproducible quality of the structures made and compliance with PRS requirements.

**25.1.4** The manufacturer shall employ welders holding valid PRS qualification certificates necessary (see paragraph 23.1.1) for performance of the welding processes within the scope of the approval requested by the manufacturer.

**25.1.5** The condition for issuance by PRS the *Approval Certificate* is a satisfactory result of the approval procedure used. The detailed range of approval is specified in the Annex to the *Approval Certificate*.

**25.1.6** *Approval Certificate* issued for one manufacturer's plant also applies to their branches provided they report to the same quality management unit and the same technical supervision.

**25.1.7** *Approval Certificate* is issued, by PRS, for a three-year period. The condition for maintaining the certificate validity for three years is the manufacturer's compliance with the conditions specified in *Approval Certificate*. The manufacturer shall conduct an ongoing analysis – in accordance with the requirements specified in *Publication 80/P – Non-destructive Testing*, of welding quality based on the results of non-destructive testing of the welds performed and determine the percentage quality index of welded joints at least once in six months.

**25.1.8** Prior to the *Approval Certificate* expiry date, the manufacturer intending to renew its validity shall request PRS to renew the *Approval Certificate*. This shall take place in sufficient advance so that the renewal procedure can be completed and the *Approval Certificate* be issued before the expiry date of the existing *Approval Certificate*.

**25.1.9** Extension of the approval specified in the *Approval Certificate* may take place at the request of the manufacturer during the period of validity of the existing approval or within the approval renewal procedure. The procedure and requirements are the same as in the case of manufacturer approval.

## 25.2 Approval Procedure

**25.2.1** Manufacturer intending to obtain an approval shall request PRS to initiate the approval procedure. Together with the relevant request, the technical documentation including the organisation and technical particulars concerning the manufacturer specified in sub-chapter 25.3 as well as the welding procedure qualification programme corresponding to the requested scope of approval shall be submitted.

**25.2.2** Approval procedure covers:

- consideration of the technical documentation submitted by the manufacturer,
- acceptance of welding procedure qualification programme,
- supervision of the welding procedure qualification tests, performed by the manufacturer, corresponding to the scope of approval,
- manufacturer inspection.

## 25.3 Technical Documentation

**25.3.1** Documentation of the manufacturer requesting PRS approval for using particular welding processes shall include the following:

- manufacturer's name,
- manufacturer's organisation chart,
- description of the plant experience in construction or repair of welded structures,
- manufacturer's reference list, e.g. copies of approval certificates issued by other bodies, copies of quality management system certificates, etc.,
- requested scope of approval, as required in paragraph 25.1.2,
- particulars concerning the person supervising the welding operations at the manufacturer and other welding personnel and quality control staff, including their qualifications, record of work and authorisation,
- list of the welders employed who have valid PRS certificates; for welders having certificates issued by other institutions, the name of such institution shall be provided,
- description of the plant technical infrastructure including: production workshops possessed, storage rooms – including a store room for welding consumables, lifting appliances, machining appliances used for edge preparation for welding, fusion cutting appliances as well as welding appliances – including type and year of their manufacture, pre-heating appliances, post-weld heat treatment appliances, stationary and holding ovens for welding consumables, welding equipment,
- parent materials used (grades, product types, dimensional ranges),
- welding consumables used,
- welding procedure specifications used, and other documents applied by the manufacturer during welding operations, e.g. concerning the welding sequence, welding consumables' handling, welding operations quality control, performing of non-destructive testing and other tests.

The above mentioned particulars concerning the manufacturer may be communicated to PRS by completing the relevant PRS form to which copies of the required documents shall be enclosed.

## 25.4 Manufacturer Inspection

**25.4.1** Manufacturer inspection is intended to verify the data provided by the manufacturer. Where welding processes are being performed at the separate manufacturer's plants at different locations and they report to the same the same quality management unit and the same technical supervision, the inspection also applies to those plants.

**25.4.2** The inspection covers technical and organisational conditions at the manufacturer in respect of welding processes being the subject of the requested approval. The manufacturer inspection is intended to verify:

- supervising personnel – by verifying documents confirming their theoretical job knowledge, hand-on experience and authorisation of the welding supervision staff and quality control staff,
- welders – by verifying welders' register, validity of welders' qualification certificates issued by PRS corresponding to the requested approval, methods of marking the welds performed by particular welders, welders' identification marks,
- plant equipment – by verifying the condition of cutting appliances, welding appliances, as well as drying appliances and conditions of storage of covered electrodes and fluxes for submerged-arc welding, register of the possessed equipment, its supervision and periodical maintenance,
- documentation – by verifying welding procedure specifications used and other corporate documents in force applicable to the welding operations, e.g. concerning the welding sequence, welding consumables' handling, welding quality control, non-destructive testing or other tests, welding operations' quality, validity of standards possessed, principles of familiarising welders with this documentation, availability of this documentation at workstations, methods of filing of both the performed welding operations and documentation of welding operations' quality, traceability of welding conditions, and identification of welders performing the welds,
- materials – by verifying the methods of storage of parent materials and welding consumables, marking of parent materials and preparing consumables for welding.

## 25.5 Welding Procedure Qualification

**25.5.1** PRS conducts welding procedure qualification in accordance with the following requirements:

- *Publication 74/P – Principles for Welding Procedure Qualification Tests* – the requirements of this *Publication* are applicable during the qualification of welding procedure for normal-strength and higher-strength hull steels as well as aluminum alloys intended for construction of ship hulls and other marine structures intended for welded structures, welded steel forgings and steel castings and also wrought aluminium alloys which fulfil the requirements specified in these *Rules* and equivalent materials,
- *Publication 48/P – Requirements Concerning Gas Tankers* – the requirements for qualification of welding procedure for materials intended for construction of gas tankers,
- standards of PN-EN ISO 15614 series or in accordance with an agreed specification (e.g. ASME, EEMUA, etc.).

**25.5.2** Manufacturer shall develop the welding procedure qualification programme corresponding to the scope of requested approval. Preliminary Welding Procedure Specification (pWPS) shall be enclosed to the programme.

**25.5.3** Processes of qualification of the procedures of welding materials and products not covered by the above mentioned *Publications* shall be conducted in accordance with the programme agreed with PRS. This programme shall take account of specific properties of such materials and products as well as the requirements specified in the relevant standards.

**25.5.4** After these documents have been accepted by PRS, the manufacturer may begin the process of the welding procedure qualification under the direct supervision of PRS Surveyor.

**25.5.5** The set of documents concerning the performed process of welding procedure qualification shall include:

- Preliminary Welding Procedure Specification (pWPS) for the test assembly preparation,
- agreed welding procedure qualification programme,

- copies of the approval certificates for parent materials and welding consumables used for the test assembly preparation,
- records of the test assembly welding parameters confirmed by the supervising surveyor,
- reports on all destructive and non-destructive tests of the test assembly,
- welding procedure qualification record (WPQR),
- welding procedure specification (WPS) being the record of the verified process of welding procedure qualification.

**25.5.6** Welding procedure qualification record (WPQR) signed by PRS Surveyor constitutes the basis for development, by the manufacturer, welding procedure specifications, however solely in the scope corresponding to the qualification range resulting from the performed procedure.

**25.5.7** Welding procedure qualification record does not have an expiry date. Its validity is conditional on maintaining, by the manufacturer, the same technical specifications during welding process as those entered in the welding procedure qualification record (WPQR).

**25.5.8** Qualification ranges resulting from the successful welding procedure qualification processes constitute the basis for determining the scope of the manufacturer approval.

**25.5.9** Within the manufacturer approval procedure, PRS may recognise welding qualification procedures performed under the supervision of other independent technical survey bodies. The manufacturer shall submit a complete set of the relevant documents to be considered by PRS in accordance with the requirements specified in paragraph 25.5.6.

---

## APPENDIXES

### Appendix A

#### Approval Procedure for Manufacturer of Hull Structural Steels

##### A1 APPROVAL PROCEDURE FOR MANUFACTURER OF SEMI-FINISHED PRODUCTS

###### 1 Scope

Part A1, Appendix A specifies (as provided in paragraph 3.2.1, this *Part*) the procedure for the approval of the manufacturing process of semi-finished products, such as ingots, slabs, blooms and billets for hull structural steels.

The manufacturing process approval procedure is valid for verifying the manufacturer's capability to provide satisfactory products stable under effective process and production controls in operation. The products shall be subjected to approval in accordance with the requirements of sub-chapter 3.2 in this *Part*.

###### 2 Request for Approval

###### 2.1 Documents to be Submitted

The manufacturer shall submit, to PRS, a request for approval, the proposed approval test programme (see sub-chapter 3.1) and the following information:

- .1 name and address of the manufacturer, location of the workshops, general indications relevant to the background, production range, estimated total annual production of finished products for shipbuilding and for other applications;
- .2 the works organization and the quality management system:
  - organizational chart,
  - staff employed, responsible for manufacturing process,
  - staff employed and organization of the quality control department,
  - qualification of the personnel involved in activities related to the quality of the products,
  - certification of the quality management system (if established),
  - *Approval Certificates* already granted by another Classification Societies (if any);
- .3 manufacturing facilities:
  - flow chart of the manufacturing process,
  - origin and storage of raw materials,
  - storage of the finished products,
  - equipment for systematic control during fabrication;
- .4 details of inspections and quality control facilities, in particular:
  - details of the system used for identification of materials at the different stages of manufacture,
  - equipment for chemical analyses and the relevant calibration procedures,
  - list of quality control and quality management procedures;
- .5 types of products (ingots, slabs, blooms, billets), types of steel (normal or higher strength), range of thickness and the expected material properties such as:
  - range of chemical composition and the analysis of grain refining, micro alloying and residual elements for the various grades of steel; if the range of the chemical composition depends on thickness and supply condition, the different ranges shall be specified, as appropriate,
  - maximum carbon equivalent CEV,
  - maximum  $P_{cm}$  content for higher strength steel with low carbon content ( $C < 0.13 \%$ ),

- production statistics of the chemical composition and if available at rolling mills, mechanical properties ( $R_e$ ,  $R_m$ ,  $A$  and  $KV$ ), intended to demonstrate the capability to manufacture the steel products in accordance with the requirements of *this Part*,
- .6 steelmaking process:
  - steelmaking process and capacity of furnace/s or converter/s,
  - raw material used,
  - deoxidation and alloying practice,
  - desulphurisation and vacuum degassing installations, if any,
  - casting methods: ingot or continuous casting. In the case of continuous casting, information relevant to type of casting machine, teeming practice, methods to prevent re-oxidation, inclusions and segregation control, presence of electromagnetic stirring, soft reduction, etc., shall be provided, as appropriate,
  - ingot or slab size and weight,
  - ingot or slab treatment: scarfing and discarding procedures,
- .7 documentation of approval tests performed under supervision of another Classification Society.

## 2.2 Documents to be Submitted for Changing the Approval Conditions

In such cases as:

- .1 change of the manufacturing process (steel making process, casting method, steelmaking plant, caster),
- .2 change of the maximum thickness (dimensions),
- .3 change of the chemical composition, added elements, etc.,

the manufacturer shall submit to PRS the documents, required in sub-chapter 2.1, and the request for changing the approval conditions.

However, where the documents are duplicated by the ones at the previous approval for the same type of product, part or all of the documents may be omitted, except the approval test programme (see sub-chapter 3.1).

## 3 Approval Tests

### 3.1 Extent of Approval Tests

The extent of the test programme is specified in sub-chapter 3.6. It may be modified on the basis of the preliminary information submitted by the manufacturer.

This refers, in particular, to a reduction of the indicated number of casts, product thicknesses and steel types to be tested or waiving the approval tests. PRS may accept such proceeding taking into account:

- .1 approval already granted by another Classification Society and documentation of the approval tests performed,
- .2 grades of steel to be approved and availability of long-term statistic results of chemical and mechanical properties,
- .3 change of the approval conditions.

On the other hand, an increase of the number of casts and thicknesses to be tested may be required in the case of newly developed types of steel or manufacturing processes.

### 3.2 Approval Tests Programme

Where the extent of the tests differs from that specified in sub-chapter 3.6, the programme shall be agreed with PRS before the tests.



### 3.3 Approval Tests Supervision

The approval tests shall be supervised by PRS Surveyor at the manufacturer's plant. The execution of the plant inspection in operation may be required by PRS Surveyor during the approval tests. If the testing facilities are not available at the works, the tests shall be performed at approved laboratories.

### 3.4 Selection of the Test Product

For each type of steel and for each manufacturing process (e.g. steelmaking, casting), one test product with the maximum thickness (dimension) to be approved shall be selected for each kind of product.

The selection of the casts for the test product shall be based on the typical chemical composition, with particular regard to the specified CEV,  $P_{cm}$  values and grain refining micro-alloying additions.

### 3.5 Position of Test Samples

Unless agreed otherwise, the test samples shall be taken from the product (slabs, blooms, billets) corresponding to the top of the ingot or, in the case of continuous casting, a random sample.

### 3.6 Tests of Semi-finished Products

#### 3.6.1 Type of Tests

For the approval of the manufacturing process of semi-finished products, the following tests shall be performed:

- .1 chemical analysis; the analysis shall be complete and shall include micro alloying elements,
- .2 sulphur prints.

In addition, for initial approval and for each renewal of approval PRS may require full tests, specified in Chapter 3, Part A2, Appendix A to be performed. The tests shall be performed at rolling mill on the minimum thickness semi-finished product.

In the case of a multi-caster work, full tests on finished products shall be performed for one caster. For other casters, reduced tests (chemical analysis and sulphur prints) shall be performed. The tests shall be performed on the minimum thickness semi-finished product.

#### 3.6.2 Test Specimens and Testing Procedure

The following tests shall be performed:

- .1 chemical analysis:  
both the ladle and product analyses shall be made. The content of the following elements shall be checked: C, Mn, Si, P, S, Ni, Cr, Mo, Al, N, Nb, V, Cu, As, Sn, Ti and, for steel manufactured from electric or open-hearth furnace, Sb and B,
- .2 Baumann printing (sulphur print test):  
sulphur prints shall be taken from product edges which are perpendicular to the axis of the ingot or slab. These sulphur prints shall be approximately 600 mm long taken from the centre of the edge selected and shall include the full plate thickness.

## 4 Results

All required information, specified in Chapter 2, Part A2 of the present Appendix, applicable to the products subjected to the tests shall be collected by the manufacturer and put in reports which will include all the results of the tests and operation records relevant to steel making, casting and, where applicable, rolling and heat treatment of the test products.

These reports shall be submitted to PRS. Depending on the test results, particular limitations or testing conditions, as deemed appropriate, may be specified in the *Approval Certificate*.

## 5 Approval

If the results of the inspection and approval tests are satisfactory, PRS will issue *Approval Certificate* stating at least:

- .1 type of product (ingots, slabs, blooms, billets),
- .2 steelmaking and casting process,
- .3 thickness range of the semi-finished products,
- .4 types of steel (normal or higher strength).

## 6 Renewal of Approval

The validity of *Approval Certificate* shall be a maximum of three years. Renewal of approval can be performed at the manufacturer's request, which shall be submitted before the expiry date of the approval validity and after conducting inspection confirming that the approval conditions are complied with.

Manufacturers who have not produced the approved grades and products (UR) during the period between renewals may be required to either carry out approval tests or, on the basis of results of production of similar grades of products, at the discretion of PRS, be reapproved.

Where, for operational reasons, the renewal audit falls beyond the period of approval, the manufacturer will still be considered as approved if agreement to this audit date is made within *Approval Certificate* validity. In such case, upon satisfactory renewal audit, PRS extends the *Approval Certificate* with validity from the original renewal date.

## 7 Withdrawal of Approval

PRS may withdraw the approval in the following cases:

- .1 in service failures, traceable to the product quality,
- .2 non-conformity of the product revealed during fabrication or construction,
- .3 discovered failures of the manufacturer's quality system,
- .4 changes made by the manufacturer, without the prior agreement with PRS, to the approval extent specified in the *Approval Certificate*,
- .5 major non-conformities (discovered at testing the products).

## A2 APPROVAL PROCEDURE FOR MANUFACTURER OF HULL STRUCTURAL STEELS

### 1 Scope

Part A2, Appendix A specifies (as provided in paragraph 3.2.1, this *Part*), the procedure for the approval of the manufacturing process of normal and higher strength hull structural steels.

The manufacturing approval procedure is valid for verifying the manufacturer's capability to provide satisfactory products stable under effective process and production controls in operation. The products shall be subjected to approval in accordance with the requirements of sub-chapter 3.2, this *Part*.

### 2 Request for Approval

#### 2.1 Documents to be Submitted

The manufacturer shall submit, to PRS, a request for approval, the proposed approval test programme (see sub-chapter 3.1) and the following information:

- .1 name and address of the manufacturer, location of the workshops, general indications relevant to the background, production range, estimated total annual production of the finished products for shipbuilding and for other applications,
- .2 the works organization and the quality management system:
  - organizational chart,
  - staff employed, responsible for manufacturing process,
  - staff employed and organization of the quality control department,
  - qualification of the personnel involved in activities related to the quality of the products,
  - certification of the quality management system (if established),
  - *Approval Certificates* already granted by another Classification Societies (if any);
- .3 manufacturing facilities:
  - flow chart of the manufacturing process,
  - origin and storage of raw materials,
  - storage of the finished products,
  - equipment for systematic control during fabrication;
- .4 details of inspections and quality control facilities, in particular:
  - details of the system used for identification of materials at the different stages of manufacture,
  - equipment for mechanical tests, chemical analyses, metallographic examination and relevant calibration procedures,
  - equipment for non-destructive tests,
  - list of quality control and quality management procedures;
- .5 types of products (plates, sections, coils), grades of steel, range of thickness and the expected material properties, as follows:
  - the range of chemical composition and the analysis of grain refining, micro-alloying and residual elements for the various grades of steel; if the range of the chemical composition depends on thickness and supply condition, the different ranges shall be specified, as appropriate,
  - maximum carbon equivalent CEV,
  - maximum  $P_{cm}$  content for higher strength steel with low carbon content ( $C < 0.13 \%$ ),
  - production statistics of the chemical composition and mechanical properties ( $R_e$ ,  $R_m$ ,  $A$  and  $KV$ ), intended to demonstrate the capability to manufacture the steel products in accordance with the requirements of this *Part*,

- .6 steelmaking process:
  - steelmaking process and capacity of furnace/s or converter/s,
  - raw material used,
  - deoxidation and alloying practice,
  - desulphurisation and vacuum degassing installations, if any,
  - casting methods: ingot or continuous casting. In the case of continuous casting, information relevant to type of casting machine, teeming practice, methods to prevent re-oxidation, inclusions and segregation control, presence of electromagnetic stirring, soft reduction, etc., shall be provided, as appropriate,
  - ingot or slab size and weight,
  - ingot or slab treatment: scarfing and discarding procedures,
- .7 reheating and rolling:
  - type of furnace and treatment parameters,
  - rolling: reduction ratio of slab/bloom/billet to the finished product thickness, rolling and finishing temperatures,
  - descaling treatment during rolling,
  - capacity of the rolling stands;
- .8 heat treatment:
  - type of furnaces, heat treatment parameters and their relevant records,
  - accuracy and calibration of temperature control devices;
- .9 programmed rolling: for products delivered in the controlled rolling (CR) or thermo-mechanical rolling (TM) condition, the following additional information on the programmed rolling schedules shall be given:
  - description of the rolling process,
  - normalizing temperature, re-crystallization temperature and  $A_{r3}$  temperature and the methods used to determine the parameters,
  - control standards for typical rolling parameters used for the different thicknesses and grades of steel (temperature and thickness at the beginning and at the end of the passes, interval between passes, reduction ratio, temperature range and cooling speed of accelerated cooling, if any) and the relevant method of control,
  - calibration of the control equipment;
- .10 recommendations for working and welding, in particular for products delivered in the CR or TM condition:
  - cold and hot working recommendations if needed in addition to the normal practice used in the shipyards and workshops,
  - minimum and maximum heat input if different from the ones usually used in the shipyards and workshops (15 ÷ 50 kJ/cm);
- .11 additional information on the manufacturing process shall be included if any part of the process is assigned to another firms or manufacturing plants,
- .12 documentation of approval tests performed under supervision of another Classification Society.

## 2.2 Documents to be Submitted for Changing the Approval Conditions

In such cases as, where applicable:

- .1 change of the manufacturing process (steel making, casting, rolling and heat treatment),
- .2 change of the maximum thickness (dimensions),
- .3 change of the chemical composition, added elements, etc.,
- .4 subcontracting the rolling, heat treatment, etc.,
- .5 the use of the slabs/blooms/billets manufactured by other manufacturers which are not approved by PRS,

the manufacturer shall submit to PRS the documents, required in sub-chapter 2.1, and the request for changing the approval conditions.

However, where the documents are duplicated by the ones at the previous approval for the same type of product, part or all of the documents may be omitted, except the approval test programme (see sub-chapter 3.1).

### **3 Approval Tests**

#### **3.1 Extent of Approval Tests**

**3.1.1** The extent of the test programme is specified in sub-chapters 3.6 and 3.7. It may be modified on the basis of the preliminary information submitted by the manufacturer.

This refers, in particular, to a reduction of the indicated number of casts, steel plate thicknesses and grades to be tested or waiving the approval tests. PRS may accept such proceeding taking into account, as follows:

- .1 approval already granted by another Classification Society and documentation of approval tests performed,
- .2 types of steel to be approved and availability of long-term statistic results of chemical and mechanical properties performed on rolled products,
- .3 approval for any grade of steel also covering approval for any lower grade in the same strength level, provided that method of manufacture and condition of supply are similar,
- .4 for higher tensile steels, approval of one strength level covering the approval of the strength level immediately below, provided the steelmaking process, deoxidation and fine grain practice, casting method and condition of supply are the same,
- .5 change of the approval conditions.

On the other hand, an increase of the number of casts and thicknesses to be tested may be required in the case of newly developed types of steel or manufacturing processes.

**3.1.2** In the case of multi-source slabs or changing the slab manufacturer, the rolled steel manufacturer is required to obtain the approval of the manufacturing process of rolled steels using slabs from each slab manufacturer and to conduct approval tests in accordance with 3.6 and 3.7. A reduction or waiving the approval tests may be considered by PRS taking into account the previous approval, as follows:

- .1 the rolled steel manufacturer has already been approved for the manufacturing process using other semi-finished products characterized by the same thickness, steel grade, grain refining and micro-alloying elements, steelmaking and casting process,
- .2 the semi-finished products manufacturer has been approved for the complete manufacturing process with the same conditions (steelmaking, casting, rolling and heat treatment).

#### **3.2 Approval Test Programme**

Where the extent of the tests differs from that specified in sub-chapters 3.6 and 3.7, the approval test programme shall be agreed with PRS before the tests.

#### **3.3 Approval Tests Supervision**

The approval tests shall be supervised by PRS Surveyor at the manufacturer's plant. The execution of the plant inspection in operation may be required by PRS Surveyor during the approval tests. If the testing facilities are not available at the works, the tests shall be performed at approved laboratories.

### 3.4 Selection of the Test Product

For each grade of steel and for each manufacturing process (e.g. steel making, casting, rolling and condition of supply), one test product with the maximum thickness (dimension) to be approved shall be selected for each kind of product.

In addition, for initial approval, PRS may require the selection of one test product of average thickness.

The selection of the casts for the test product shall be based on the typical chemical composition, with particular regard to the specified CEV,  $P_{cm}$  values and grain refining micro-alloying additions.

### 3.5 Position of Test Samples

Unless agreed otherwise, the test samples shall be taken from the product (plate, flat, section, bar) corresponding to the top of the ingot or, in the case of continuous casting, a random sample.

The position of test samples shall be in accordance with paragraph 3.9.3, this *Part*. The term “piece” is defined in paragraph 3.9.1, this *Part*. The direction of the test specimens with respect to the final direction of rolling of the material shall be as indicated in Table 3.6.1 of Appendix.

### 3.6 Parent Material Tests

#### 3.6.1 Type of Tests

The tests shall be carried in accordance with Table 3.6.1.

**Table 3.6.1**  
**Parent Material Tests**

Type of test	Position of test samples and direction of the test specimens <sup>1)</sup>	Remarks				
Tensile test	Top and bottom transverse test specimens <sup>2)</sup>	$R_e, R_m, A$ shall be stated in test report				
Tensile test (stress relieved) only for TM steels	Top and bottom transverse test specimens <sup>2</sup>	Stress relieving at 600 °C (2 min/mm for min. 1 hour)				
Impact tests <sup>3)</sup> on non-aged specimens for grades	Top and bottom – longitudinal test specimens	Test temperature [°C]				
A, B, AH32, AH36, AH40		+20	0	-20		
D, DH32, DH36, DH40		0	-20	-40		
E, EH32, EH36, EH40		0	-20	-40	-60	
FH32, FH36, FH40		-20	-40	-60	-80	
A, B, AH32, AH36, AH40		Top and bottom – transverse test specimens <sup>4)</sup>	+20	0	-20	
D, DH32, DH36, DH40			0	-20	-40	
E, EH32, EH36, EH40			-20	-40	-60	
FH32, FH36, FH40	-40		-60	-80		
Impact test <sup>3)</sup> on strain aged test specimens <sup>5)</sup>	Top – longitudinal test specimens	Test temperature [°C]				
AH32, AH36, AH40		+20	0	-20		
D, DH32, DH36, DH40		0	-20	-40		
E, EH32, EH36, EH40		-20	-40	-60		
FH32, FH36, FH40	-40	-60	-80			
Chemical analyses <sup>6)</sup>	Top	Complete analysis, including micro alloying elements				

Type of test	Position of test samples and direction of the test specimens <sup>1)</sup>	Remarks
Sulphur prints	Top	
Micro examination	Top	
Grain size determination	Top	Only for fine grain steels
Pellini drop weight test <sup>4)</sup>	Top	Only for grades E, EH32, EH36, EH40, FH32, FH36, FH40
Through thickness tensile test	Top and bottom	Only for grades with improved through thickness properties
<p><sup>1)</sup> For hot rolled strips, see paragraph 3.6.2.  <sup>2)</sup> Longitudinal direction for sections and plates having the width less than 600 mm.  <sup>3)</sup> One set of 3 Charpy V-notch impact test specimens is required for each impact test.  <sup>4)</sup> Not required for sections and plates having the width less than 600 mm.  <sup>5)</sup> Deformation 5% + 1 hour at 250 °C.  <sup>6)</sup> Besides product analyses, ladle analyses are required.</p>		

### 3.6.2 Test Specimens and Testing Procedure

The test specimens and testing procedures shall be in accordance with the requirements of Chapter 2, this *Part*. In particular the following applies:

#### .1 *tensile test:*

- for plates made from hot rolled strips, one additional tensile test specimen shall be taken from the middle of the strip constituting the coil,
- for plates having the thickness greater than 40 mm, when the capacity of the available testing machine is insufficient to allow the use of test specimens of full thickness, multiple flat specimens, representing collectively the full thickness, can be used. Alternatively, two round specimens with the axis located at one quarter and at mid-thickness can be taken;

#### .2 *impact test:*

- for plates made from hot rolled strip, one additional set of impact test specimens shall be taken from the middle of the strip constituting the coil,
- for plates having thickness greater than 40 mm, one additional set of impact specimens shall be taken with the axis located at mid-thickness,
- in addition to the determination of the energy value, also the lateral expansion and the percentage crystallinity shall be reported;

#### .3 *chemical analysis:*

both the ladle and product analyses shall be made. The material for the product analyses should be taken from the tensile test specimen. The content of the following elements shall be checked: C, Mn, Si, P, S, Ni, Cr, Mo, Al, N, Nb, V, Cu, As, Sn, Ti and, for steel manufactured from electric or open-hearth furnace, Sb and B;

#### .4 *Baumann printing (sulphur print test):*

sulphur prints shall be taken from plate edges which are perpendicular to the axis of the ingot or slab. These sulphur prints shall be approximately 600 mm long taken from the centre of the edge selected, i.e. on the ingot centreline and shall include the full plate thickness;

#### .5 *micrographic examination:*

the micrographs shall be representative of the full thickness. For thick products, in general, at least three examinations shall be made at surface, one quarter and mid-thickness of the product. All photomicrographs shall be taken at x100 magnification and where ferrite grain

size exceeds ASTM 10, additionally at x500 magnification. Ferrite grain size should be determined for each photomicrograph;

**.6 Pellini test (drop weight test – DWT):**

the test shall be performed in accordance with the requirements of sub-chapter 2.8, this *Part*. The NDTT shall be determined and photographs of the tested specimens shall be taken and enclosed with the test report;

**.7 through thickness tensile test:**

the test shall be performed in accordance with the requirements of Chapter 5, this *Part*. The test results shall be in accordance, where applicable, with the requirements specified in Chapter 3, this *Part* for the tested steel grades.

### 3.6.3 Other Tests

For newly developed types of steel not covered by the requirements of Chapter 3, this *Part*, additional tests such as CTOD test, large scale brittle fracture tests (Double Tension test, ESSO test, Deep Notch test, etc.) or other tests may be required by PRS.

## 3.7 Weldability Tests

### 3.7.1 Extent of the Tests

Weldability tests are required for plates and shall be performed in accordance with 2.12, this *Part* on test samples taken from the thickest plate. Weldability tests are required for normal strength grade E and for higher strength steels.

### 3.7.2 Preparation and Welding of the Test Assemblies

The following test assemblies shall be prepared:

- .1 1 butt weld test assembly welded with a heat input approximately 15 kJ/cm,
- .2 1 butt weld test assembly welded with a heat input approximately 50 kJ/cm.

The butt weld test assemblies shall be prepared with the weld seam transverse to the plate rolling direction, so that impact specimens will result in the longitudinal direction.

The bevel preparation should be preferably 1/2V or K.

The welding procedure shall be as far as possible in accordance with the normal welding practice used at the yards for the type of steel in question.

Test report shall contain the welding procedure specification (WPS) used for the weld test assemblies and copies of certificates issued for welding consumables used for the test assemblies preparation.

### 3.7.3 Types of Tests

From the test assemblies, the following test specimens shall be taken:

- .1 1 cross weld tensile test specimen;
- .2 a set of 3 Charpy V-notch impact test specimens transverse to the weld with the notch located at the fusion line and at a distance 2, 5 and minimum 20 mm from the fusion line. The fusion boundary shall be identified by etching the specimens with a suitable reagent. The test temperature shall be the one prescribed for the testing of the steel grade in question;
- .3 hardness tests HV5 across the weldment. The indentations shall be made along a 1 mm transverse line beneath the plate surface on both the face side and the root side of the weld as follows:
  - fusion line,



- HAZ: at each 0.7 mm from fusion line into unaffected parent material (minimum 6 to 7 measurements for each HAZ).

The maximum hardness value shall be not higher than 350 HV.

A sketch of the weld joint depicting groove dimensions, number of passes, hardness indentations shall be attached to the test report, together with photomicrographs of the weld cross-section.

#### 3.7.4 Other Tests

For newly developed types of steel not covered by Chapter 3, this *Part*, additional tests such as cold cracking tests (CTS, Cruciform, Implant, Tekken, Bead-on plate), CTOD or other tests may be required by PRS.

### 4 Results

All required information, specified in Chapter 2, applicable to the products subjected to the tests, shall be collected by the manufacturer and put in reports which will include all the results of the tests and operation records relevant to steel making, casting, rolling and heat treatment of the test products.

These reports shall be submitted to PRS. Depending on the test results, particular limitations or testing conditions, as deemed appropriate, may be specified in the *Approval Certificate*.

### 5 Approval

If the results of the inspection and approval tests are satisfactory, PRS will issue *Approval Certificate*.

### 6 Renewal of Approval

The validity of *Approval Certificate* shall be a maximum of three years. Renewal of approval can be performed at the manufacturer's request, which shall be submitted before the expiry date of the approval validity and after conducting inspection confirming that the approval conditions are complied with.

Manufacturers who have not produced the approved grades and products during the period between renewals may be required to either carry out approval tests or, on the basis of results of production of similar grades of products, at the discretion of PRS, be reapproved.

Where, for operational reasons, the renewal audit falls beyond the period of approval, the manufacturer will still be considered as approved if agreement to this audit date is made within *Approval Certificate* validity. In such case, upon satisfactory renewal audit, PRS extends the *Approval Certificate* with validity from the original renewal date.

### 7 Withdrawal of Approval

PRS may withdraw the approval in the following cases:

- .1 in service failures, traceable to the product quality,
- .2 non-conformity of the product revealed during fabrication or construction,
- .3 discovered failures of the manufacturer's quality system,
- .4 changes made by the manufacturer, without the prior agreement with PRS, to the approval extent specified in the *Approval Certificate*,
- .5 major non-conformities (discovered at testing the products).

**Appendix B****Approval Procedure for Manufacturer of Hull Structural Steels  
Intended for Welding with High Heat Input****1 Scope**

The present *Appendix* specifies the weldability confirmation procedure for normal and higher strength hull structural steels intended for welding with high heat input (over 50 kJ/cm).

The weldability confirmation procedure shall be generally applied by the manufacturer's option and shall be valid for certifying that the steel has satisfactory weldability for high heat input welding concerned under testing conditions.

Demonstration of conformance to the requirements of this document approves a particular steel mill to manufacture grade of steel to the specific chemical composition range, melting practice and processing practice for which conformance was established. The approval procedure does not apply to qualification of welding procedures to be undertaken by welded structures manufacturers.

**2 Request for Approval**

The manufacturer seeking the approval shall submit to PRS a request for approval, the proposed approval tests programme (see sub-chapter 3.2) and the following technical documentation:

- .1 a description of products subject to approval:
  - grade,
  - thickness range,
  - deoxidation method,
  - fine grain practice,
  - range of chemical composition,
  - maximum CEV and  $P_{cm}$ ,
  - production statistics of mechanical properties (tensile and Charpy V-notch impact tests);
- .2 manufacturing control points to prevent toughness deterioration in heat affected zone when welded with high heat input, relevant to chemical elements, steelmaking, casting, rolling, heat treatment, etc.;
- .3 welding control points to improve joint properties on strength and toughness.

**3 Tests****3.1 Extent of Approval Tests**

Unless agreed otherwise with PRS, the range of approval tests for steel grades shall be as follows:

- .1 approval tests of the lowest and highest toughness levels cover the intermediate toughness level;
- .2 approval tests of normal strength level cover that strength only;
- .3 for high tensile steel, approval tests of one strength level cover strength level immediately below;
- .4 tests may be performed separately subject to the same manufacturing process;
- .5 the results of approval tests performed under the supervision of another Classification Society may be accepted by PRS subject to special consideration.

**3.2 Weldability Test Programme**

Weldability tests are required for plates and shall be performed in accordance with the requirements of sub-chapter 2.12, this *Part*, having regard to the requirements of the present *Appendix*.

The extent of the test programme is specified in sub-chapter 3.5. It may be modified according to the range of certification. In particular, additional test assemblies and/or tests may be required in the case of newly developed types of steel, welding consumables, new welding method or when deemed necessary by PRS.

Where the extent of the tests differs from that specified in sub-chapter 3.5, the test programme shall be agreed with PRS before the tests.

### 3.3 Test Plates

Test plates shall be manufactured by a process approved by PRS, in accordance with the requirements of *Appendix A*, this *Part*.

For each manufacturing process route, two test plates with different thickness shall be selected. The thicker plate (with the thickness  $t$ ) and thinner plate (with the thickness less than or equal to  $t/2$ ) shall be proposed by the manufacturer.

Small changes in manufacturing process (e.g. within the TM process) may be considered for acceptance without testing, at the discretion of PRS.

### 3.4 Test Assemblies

One butt weld assembly welded with heat input over 50 kJ/cm shall be prepared with the weld axis transverse to the plate rolling direction.

The dimensions of the test assembly shall be amply sufficient to take all required test specimens specified in sub-chapter 3.5.

The welding procedure shall be as far as possible in accordance with the normal practices applied at shipyards for the test plate concerned.

Test report shall contain the following data: welding process, welding position, welding consumables (manufacturer, type, grade, diameter and shielding gas), welding parameters, including bevel preparation, heat input, preheating temperatures, interpass temperatures, number of passes, etc.

### 3.5 Examination and Tests of the Test Assembly

Unless agreed otherwise with PRS, the test assembly shall be examined and tested in accordance with sub-paragraphs .1 ÷ .8:

#### .1 *Visual inspection*

Overall welded surface shall be uniform and free from injurious defects such as cracks, undercuts, overlaps, etc.

#### .2 *Macroscopic tests*

One macroscopic photograph shall be representative of transverse section of the welded joint and shall show absence of cracks, lack of penetration, lack of fusion and other injurious defects.

#### .3 *Microscopic tests*

micrograph with x100 magnification shall be taken at the following positions:

- the weld centreline,
- fusion line

and at a distance 2, 5, 10 and minimum 20 mm from the fusion line. The test results are provided for information purpose only.

**.4 Hardness test**

Along two lines across transverse weld section 1mm beneath plate surface on both face and root side of the weld, indentations by HV5 shall be made at weld metal centreline, fusion line and each 0.7 mm position from fusion line to unaffected parent material (minimum 6 to 7 measurements for each heat affected zone). The maximum hardness value shall not be higher than 350 HV.

**.5 Tensile test**

Two flat tensile test specimens shall be taken from the test assembly. The test specimens and testing procedures shall comply with the requirements of Chapter 2, this *Part*.

The tensile strength shall be not less than the minimum required value for the grade of the parent material.

**.6 Bend test**

Two bend test specimens shall be taken from the test assembly and bent on a mandrel with diameter of quadruple the specimen thickness. Bending angle shall be at least 120°. Test specimens shall comply with the requirements of Chapter 2, this *Part*.

For plate thickness up to 20 mm, one face-bend and one root-bend specimens or two side-bend specimens shall be taken. For plate thickness over 20 mm, two side-bend specimens shall be taken.

After testing, the test specimens shall not reveal any cracks nor other open defects in any direction greater than 3 mm.

**.7 Impact test**

Charpy V-notch impact test specimens (a set of three specimens) shall be taken within 2 mm below plate surface on face side of the weld with the notch perpendicular to the plate surface.

One set of the test specimens transverse to the weld shall be taken with the notch located at the fusion line and at a distance 2, 5 and minimum 20 mm from the fusion line. The fusion boundary shall be identified by etching the specimens with a suitable reagent. The test temperature shall be the one prescribed for the testing of the steel grade in question.

For steel plates with thickness greater than 50 mm or in one side welding for plate thickness greater than 20 mm, one additional set of test specimens shall be taken from the root side of the weld with the notch located at the same position as for the face side.

The average impact energy at the specified test temperature shall comply with Tables 3.6.2-1 and 3.6.2-2 in Chapter 3, this *Part*, depending on the steel grade and thickness. Only one individual value may be below the specified average value, provided it is not less than 70% of that value.

Additional tests at the different testing temperatures may be required for evaluating the transition temperature curve of absorbed energy and percentage crystallinity at the discretion of PRS.

**.8 Other tests**

Additional tests such as wide-width tensile test, HAZ tensile test, cold cracking test (CTS, Cruciform, Implant, Tekken, and Bead-on plate), CTOD or other tests may be required at the discretion of PRS (see sub-chapter 3.2).

#### 4 Results

The manufacturer shall submit to PRS the complete test report, including all the results and required information relevant to the confirmation tests, specified in sub-chapter 3.

The test report is reviewed and evaluated by PRS in accordance with the weldability confirmation procedure.

#### 5 Approval

Upon satisfactory evaluation of the test report, *Approval Certificate* is issued by PRS.

The *Approval Certificate* shall contain the following information:

- .1 the manufacturer's name,
- .2 grade designation with notation of heat input (see Chapter 6),
- .3 deoxidation method,
- .4 fine grain practice,
- .5 supply condition,
- .6 plate thickness tested,
- .7 welding process,
- .8 welding consumables (manufacturer, type, grade),
- .9 actual heat input applied.

#### 6 GRADE DESIGNATION

Upon issuance of *Approval Certificate*, the notation indicating the value of heat input applied in the confirmation test may be added to the grade designation of the test plate, e.g. EH36-W300 (in the case of heat input 300 kJ/cm applied). The value of this notation shall be not less than 50 and every 10 added.

**Appendix C****Approval Procedure for Manufacturer of Corrosion Resistant Steel  
Used as Alternative Means of Corrosion Protection for Cargo Oil Tanks****1 General Requirements**

**1.1** This appendix specifies the procedure for approval of corrosion resistant hull steels manufacturers based upon corrosion testing.

**1.2** Approval shall be performed in accordance with the requirements of Appendixes A1 and A2 together with the additional requirements for corrosion testing specified in this Appendix.

**1.3** The corrosion test and assessment criteria shall be in accordance with the Appendix of the Annex to IMO Resolution MSC.289(87) *Performance Standard for Alternative Means of Corrosion Protection for Cargo Oil Tanks of Crude Oil Tankers*.

**2 Request for Approval**

The request for approval shall contain following information:

- corrosion test plan and details of equipment and test environments,
- technical data related to product assessment criteria for confirming corrosion resistance,
- the technical background explaining how the variation in added and controlled elements improves corrosion resistance,
- the grades, the brand name and maximum thickness of corrosion resistant steel to be approved; designations for corrosion resistant steels are given in 3.15.5 of this *Part*,
- the welding processes and the brand name of the welding consumables to be used for approval.

**3 Corrosion Test Plan**

**3.1** The manufacturer shall submit the corrosion test program, which is subject to agreement by PRS prior to tests being performed. PRS will identify tests that need to be witnessed by the surveyor.

**3.2** Method for selection of test samples shall meet the following requirements:

- .1** The numbers of test samples shall be in accordance with the requirements of the Appendix of the Annex to IMO Resolution MSC.289(87),
- .2** The number of casts and test samples selected shall be sufficient to make it possible to confirm the validity of interaction effects and/or the control range (upper limit, lower limit) of the elements which are added for improving the corrosion resistance.
- .3** Additional tests may be required by PRS when reviewing the test program against the paragraph .2.

**Remark:**

The chemical composition of the corrosion resistant steel shall be within the range specified for rolled steel for hull. Elements to be added for improving the corrosion resistance and for which content is not specified shall generally be within 1% in total.

**3.3** The approval tests shall be performed in accordance with the agreed test plan in the presence of PRS Surveyor. The Surveyor shall be present when the test samples are being identified.

**3.4** The report of the approval tests shall be submitted to PRS. The results will be assessed by PRS in accordance with the acceptance criteria specified in the Appendix of the Annex to IMO Resolution MSC.289(87).

**3.5** Upon positive results of the approval tests, *Approval Certificate* is issued by PRS.

## Appendix D

### Approval Procedure for Manufacturer of High Strength Steel for the Container Carrier Hull Construction

#### 1 General

1.1 This Appendix specifies additional requirements for approval of manufacturer of EH47 high strength steel intended for construction of container carriers hull construction.

1.2 One test product with the maximum thickness shall be selected provided the approved target chemical composition range remains unchanged.

#### 2 Scope of Tests

##### 2.1 Base Metal Tests

###### .1 Impact Test

Impact test shall be performed in accordance with 2.6 of this *Part*.

Test samples shall be taken from the plate corresponding to the top of the ingot, unless otherwise agreed. In the case of continuous casting, test samples shall be taken from a randomly selected plate.

The location of the test sample shall be at the square cut end of the plate, approximately one-quarter width from an edge. Samples shall be taken with respect to the principal rolling direction of the plate at locations representing the top and bottom of the plate as follows:

- longitudinal Charpy V-notch impact tests – top and bottom,
- transverse Charpy V-notch impact tests – top only,
- strain aged longitudinal Charpy V-notch impact test – top only.

The test are required from bot the quarter and mid thickness locations of the test samples.

One set of three Charpy V-notch impact specimens is required for each impact test. The test temperature shall be  $-40^{\circ}\text{C}$ . In the test the energy value, the lateral expansion and the percentage cristallinity shall be reported.

The ageing conditions for the determination of strain ageing resistance are specified in 2.6.4 of this *Part*.

###### .2 Fracture Mechanics Test

Deep Notch Test or CTOD (Crack Tip Opening Displacement) test shall be performed. Details of the test shall be agreed with PRS.

###### .3 Pellini Dropweight Test

Pellini Dropweight Test (DWT) shall be performed in accordance with 2.8 of this *Part*. Nil Ductility Test Temperature (NDTT) shall be reported for reference and may be used in the qualification of production test method.

###### .4 ESSO Test

ESSO test or equivalent (e.g. Double Tension Test) shall be performed in order to obtain the brittle crack arrest toughness for reference.

## 2.2 Weldability Tests

### .1 *Impact Test*

Charpy V-notch impact test shall be taken at a position of 1/4 thickness from the plate surface on the face side of the weld with the notch perpendicular to the plate surface.

One set of three specimens transverse to the weld shall be taken with the notch located at the fusion line and at a distance 2, 5 and minimum 20 mm from the fusion line. The fusion boundary shall be identified by etching the specimens with a suitable reagent. One additional set of the specimens shall be taken from the root side of the weld with the notch located at the same position and at the same depth as for the face side.

The impact test temperature is  $-40^{\circ}\text{C}$ .

### .2 *Hydrogen Crack Test*

The test method shall be in accordance with a national or international standard, agreed with PRS.

### .3 *Fracture Mechanics Test*

CTOD test or Deep Notch Test shall be performed in order to determine fracture mechanics.

---



## Appendix E

### Approval Procedure for Manufacturer of High Strength Steels for Welded Structures

#### 1 Scope

Appendix E specifies (as provided in paragraph 4.2.1, this *Part*), the procedure for the approval of the manufacturing process of high strength steels for welded structures.

All materials are to be manufactured at works which have been approved by PRS for the type, supply condition grade and thickness of steel which is being supplied. The suitability of each grade of steel for forming and welding is to be demonstrated during the initial approval tests at the steelworks.

The manufacturing approval procedure is valid for verifying the manufacturer's capability to provide satisfactory products stable under effective process and production controls in operation including programmed rolling, which is required in paragraph 4.2.2 of this *Part*.

#### 2 Request for Approval

##### 2.1 Documents to be Submitted

The manufacturer shall submit, to PRS, a request for approval, the proposed approval test programme (see sub-chapter 3.1) and the following information:

- .1 name and address of the manufacturer, location of the workshops, general indications relevant to the background, production range, estimated total annual production of the finished products,
- .2 the work of organization and the quality management system:
  - organizational chart,
  - staff employed, responsible for manufacturing process,
  - staff employed and organization of the quality control department,
  - qualification of the personnel involved in activities related to the quality of the products,
  - certification of the quality management system (if established),
  - *Approval Certificates* already granted by another Classification Societies (if any);
- .3 manufacturing facilities:
  - flow chart of the manufacturing process,
  - origin and storage of raw materials,
  - storage of the finished products,
  - equipment for systematic control during fabrication;
- .4 details of inspections and quality control facilities, in particular:
  - details of the system used for identification of materials at the different stages of manufacture,
  - equipment for mechanical tests, chemical analyses, metallographic examination and relevant calibration procedures,
  - equipment for non-destructive tests,
  - list of quality control and quality management procedures;
- .5 types of products (plates, sections, bars, tubes), supply conditions, grades of steel, range of thickness and the expected material properties, as follows:
  - the range of chemical composition and the analysis of grain refining, nitrogen binding, micro-alloying and residual elements for the various grades of steel; if the range of the chemical composition depends on thickness and supply condition, the different ranges shall be specified, as appropriate,

- where Zr, Ca and rare earth metals have been used during steelmaking for grain refinement or inclusion modification, the contents of these elements shall be specified in the manufacturing specification,
  - expected carbon equivalent values according to paragraph 4.4.3 of this *Part*,
  - production statistics of the chemical composition and mechanical properties ( $R_e$ ,  $R_m$ ,  $A$  and  $KV$ ), intended to demonstrate the capability to manufacture the steel products in accordance with the requirements of this *Part*,
- .6** steelmaking process:
- steelmaking process and capacity of furnace/s or converter/s,
  - raw material used,
  - deoxidation, grain refining, nitrogen binding and alloying practice,
  - desulphurisation, dehydrogenation, sulphide treatment, ladle refining and vacuum degassing installations, if any,
  - casting methods: ingot or continuous casting. In the case of continuous casting, information relevant to type of casting machine, teeming practice, methods to prevent re-oxidation, inclusions and segregation control, presence of electromagnetic stirring, soft reduction, etc., shall be provided, as appropriate,
  - casting/solidification cooling rate control,
  - ingot or slab size and weight,
  - ingot or slab treatment: scarfing and discarding procedures,
- .7** reheating and rolling:
- type of furnace and treatment parameters,
  - rolling: reduction ratio of slab/bloom/billet to the finished product thickness, rolling and finishing temperatures,
  - descaling treatment during rolling,
  - capacity of the rolling stands;
- .8** heat treatment:
- type of furnaces, heat treatment parameters and their relevant records,
  - accuracy and calibration of temperature control devices,
  - austenizing temperature, re-crystallization temperature and  $A_{r3}$  temperature and the methods used to determine the parameters,
  - description of quenching and tempering processes, if applicable;
- .9** programmed rolling: for products supplied in the controlled rolling (CR) or thermo-mechanical rolling (TM) condition, the following additional information on the programmed rolling schedules shall be given:
- description of the rolling process,
  - austenizing temperature, re-crystallization temperature and  $A_{r3}$  temperature and the methods used to determine the parameters,
  - control standards for typical rolling parameters used for the different thicknesses and grades of steel (temperature and thickness at the beginning and at the end of the passes, interval between passes, reduction ratio, temperature range and cooling speed of accelerated cooling, if any) and the relevant method of control,
  - calibration of the control equipment;
- .10** recommendations for working and welding, in particular for products supplied in the NR or TM condition:
- cold and hot working recommendations if needed in addition to the normal practice used in the shipyards and workshops,
  - minimum and maximum heat input and recommended preheat/interpass temperature;
- .11** additional information on the manufacturing process shall be included if any part of the process is assigned to another firms or manufacturing plants,

- .12 documentation of approval tests performed under supervision of another Classification Society.

## 2.2 Documents to be Submitted for Changing the Approval Conditions

In such cases as, where applicable:

- .1 change of the manufacturing process (steel making, casting, rolling and heat treatment),
- .2 change of the maximum thickness (dimensions),
- .3 change of the chemical composition, added elements, etc.,
- .4 subcontracting the rolling, heat treatment, etc.,
- .5 the use of the slabs/blooms/billets manufactured by other manufacturers which are not approved by PRS,

the manufacturer shall submit to PRS the documents, required in sub-chapter 2.1, and the request for changing the approval conditions.

However, where the documents are duplicated by the ones at the previous approval for the same type of product, part or all of the documents may be omitted, except the approval test programme (see sub-chapter 3.1).

## 3 APPROVAL TESTS

### 3.1 Extent of Approval Tests

**3.1.1** The extent of the test programme is specified in sub-chapters 3.6 and 3.7. It may be modified on the basis of the preliminary information submitted by the manufacturer.

This refers, in particular, to a reduction of the indicated number of casts, steel plate thicknesses and grades to be tested or waiving the approval tests. PRS may accept such proceeding taking into account, as follows:

- .1 approval already granted by another Classification Society and documentation of approval tests performed,
- .2 grades of steel to be approved and availability of long-term statistic results of chemical and mechanical properties performed on rolled products.

On the other hand, an increase of the number of casts and thicknesses to be tested may be required in the case of newly developed types of steel or manufacturing processes.

**3.1.2** In the case of multi-source slabs or changing the slab manufacturer, the rolled steel manufacturer is required to obtain the approval of the manufacturing process of rolled steels using slabs from each slab manufacturer and to conduct approval tests in accordance with 3.6 and 3.7. A reduction or waiving the approval tests may be considered by PRS taking into account the previous approval, as follows:

- .1 the rolled steel manufacturer has already been approved for the manufacturing process using other semi-finished products characterized by the same thickness, steel grade, grain refining and micro-alloying elements, steelmaking and casting process,
- .2 the semi-finished products manufacturer has been approved for the complete manufacturing process with the same conditions (steelmaking, casting, rolling and heat treatment) for the same steel grades.

### 3.2 Approval Test Programme

Where the extent of the tests differs from that specified in sub-chapters 3.6 and 3.7, the approval test programme shall be agreed with PRS before the tests.

### 3.3 Approval Tests Supervision

The approval tests shall be supervised by PRS Surveyor at the manufacturer’s plant. The execution of the plant inspection in operation may be required by PRS Surveyor during the approval tests. If the testing facilities are not available at the works, the tests shall be performed at approved laboratories.

### 3.4 Selection of the Test Product

For each grade of steel and for each manufacturing process (e.g. steel making, casting, rolling and condition of supply), one test product with the maximum thickness (dimension) to be approved shall be selected for each kind of product.

In addition, for initial approval, PRS may require the selection of one test product of average thickness.

The selection of the casts for the test product shall be based on the typical chemical composition, with particular regard to the specified CEV, CET  $P_{cm}$  values and grain refining micro-alloying additions.

### 3.5 Position of Test Samples and Specimens

Unless agreed otherwise, the test samples shall be taken from the product (plate, flat, section, bar and tubular) corresponding to the top of the ingot or, in the case of continuous casting, a random sample.

The position of test samples shall be in accordance with paragraph 3.9.3, this *Part*. The term “piece” is defined in paragraph 3.9.1, this *Part*. The direction of the test specimens with respect to the final direction of rolling of the material shall be as indicated in Table 3.6.1 of this Appendix.

The position of the tensile and Charpy impact test samples with respect to the plate thickness shall be in accordance with the requirements of paragraph 3.6.2 of Appendix A2.

### 3.6 Parent Material Tests

#### 3.6.1 Type of Tests

The tests shall be carried in accordance with Table 3.6.1.

**Table 3.6.1**  
**Parent material tests**

Type of test	Position of test samples and direction of the test specimens <sup>1)</sup>	Remarks
Chemical analyses <sup>1)</sup>	Top	Contents of C, Mn, Si, P, S, Ni, Cr, Mo, Al, N, Nb, V, Ti, B, Zr, Cu, As, Sn, Bi, Pb, Ca, Sb, O, H shall be reported CEV/CET calculation $P_{cm}$ calculation, as applicable
Sulphur prints	Top	Sulphur prints <sup>2)</sup> are to be taken from plate edges which are perpendicular to the axis of the ingot or slab. These sulphur prints shall be approximately 600 mm long taken from the centre of the edge selected, i.e. on the ingot centerline, and shall include the full plate thickness.

Type of test	Position of test samples and direction of the test specimens <sup>1)</sup>	Remarks			
Micrographic examination <sup>3)</sup>	Top	a) Grain size determination. Ferrite and/or prior austenite grain size shall be determined; b) All photomicrographs shall be taken at 100x and 500x magnification; c) Non metallic inclusion contents/Cleanliness: The level of non-metallic inclusions and impurities in term of amount, size, shape and distribution shall be controlled by the manufacturer. The standards of the micrographic examination methods ISO 4967 or equivalent are applicable. Alternative methods for demonstrating the non-metallic inclusions and impurities may be used by the manufacturer.			
Tensile test	Top and bottom longitudinal and transverse test specimens	$R_e$ , $R_m$ , $A$ , $Z$ and $R_e/R_m$ ratio shall be reported.			
Impact tests <sup>3)</sup> on non-aged specimens for grades <sup>4)</sup>	Top and bottom – longitudinal and transverse test specimens	Test temperature [°C]			
AH420÷AH960		+20	0	-20	
DH420÷DH960		0	-20	-40	
EH420÷EH960		0	-20	-40	-60
FH420÷FH690		-20	-40	-60	-80
Impact test <sup>3)</sup> on strain aged test specimens <sup>4,5)</sup>	Top – longitudinal or transverse test specimens	Test temperature [°C]			
AH420÷AH960		+20	0	-20	
DH420÷DH960		0	-20	-40	
EH420÷EH960		0	-20	-40	-60
FH420÷FH690		-20	-40	-60	-80
Pellini drop weight test <sup>6)</sup>	Top	The Nil Ductility Transition Temperature (NDTT) shall be determined and photographs of the tested specimens shall be taken and enclosed with the test report			
Through thickness tensile test	Top and bottom	Only for grades with improved through thickness properties			
Weldability test <sup>7)</sup>					
a) Butt weld assembly, as-welded	Top	Cross weld tensile test, Charpy impact test on weld metal, fusion line (FL), FL+2 mm, FL+5 mm, FL+20 mm, macro examination and hardness survey, CTOD at -10°C on grain-coarsened heat-affected zone.			
b) Butt weld assembly, PWHT, if applicable	Top				
c) Y-shape weld crack test (Hydrogen crack test)	Top				
<p><sup>1)</sup> Besides product analyses, ladle analyses are required. The product analyses shall be taken from the tensile specimen. The deviation of the product analysis from the ladle analysis shall be permissible in accordance with the limits given in the manufacturing specification.</p> <p><sup>2)</sup> Other tests than Sulphur prints for segregation examination may be applied after prior PRS acceptance.</p> <p><sup>3)</sup> One set of 3 Charpy V-notch impact test specimens is required for each impact test.</p> <p><sup>4)</sup> In addition to the absorbed energy value, also the lateral expansion and the percentage crystallinity shall be reported.</p> <p><sup>5)</sup> Deformation 5% + 1 hour at 250°C. Strain ageing test shall be carried out on the thickest plate.</p> <p><sup>6)</sup> Required only for plates.</p> <p><sup>7)</sup> Weldability test shall be carried out on the thickest plate.</p>					

### 3.6.2 Test Specimens and Testing Procedure

The test specimens and testing procedures shall be in accordance with the requirements of Chapter 2, this *Part*.

### 3.6.3 Other Tests

For newly developed types of steel not covered by the requirements of Chapter 3, this *Part*, additional tests such as CTOD test, large scale brittle fracture tests (Double Tension test, ESSO test, Deep Notch test, etc.) or other tests may be required by PRS.

## 3.7 Weldability Tests

### 3.7.1 Extent of the Tests

**3.7.1.1** For strength levels 420, 460 and 500 MPa weldability tests shall be performed on test samples taken from the thickest plate. Testing on higher grades can cover the lower strength and toughness grades.

The following test assemblies shall be prepared:

- .1 1 butt weld test assembly welded with a heat input  $15 \pm 2$  kJ/cm shall be tested as-welded,
- .2 1 butt weld test assembly welded with a heat input  $50 \pm 5$  kJ/cm for steels in N/NR and TM condition and  $35 \pm 3.5$  kJ/cm for steels in QT condition shall be tested as-welded,
- .3 1 butt weld test assembly welded with the same heat input as given in .2 shall be post-weld heat treated (PWHT) prior to testing.
- .4 when steel is intended to be designated as steel for high heat input welding, additional 1 butt weld test assembly shall be tested as-welded and 1 butt weld test assembly shall be tested in PWHT condition, both welded with the maximum heat input being approved.

**3.7.1.2** For strength levels 550, 620, 690, 890 and 960 MPa weldability tests shall be performed on test samples taken from the thickest plate with the highest toughness grade for each strength level. Provided the chemical composition of the higher grade is representative to the lower grade, testing requirements of the lower grades may be reduced at the discretion of PRS.

The following test assemblies shall be prepared:

- .1 1 butt weld test assembly welded with a heat input  $10 \pm 2$  kJ/cm shall be tested as-welded,
- .2 1 butt weld test assembly welded with a maximum heat input as proposed by the manufacturer shall be tested as-welded; the approved maximum heat input shall be stated on the approval certificate,
- .3 when the manufacturer requires to include the approval for post-weld heat treated (PWHT) condition, additional 1 butt weld test assembly welded with a maximum heat input proposed by the manufacturer same as in .2 shall be tested shall be post-weld heat treated (PWHT) prior to testing.

### 3.7.2 Preparation and Welding of the Test Assemblies

The butt weld test assemblies of plates in N/NR condition shall be prepared with the weld seam transverse to the plate rolling direction, so that impact specimens will result in the longitudinal direction.

The butt weld test assemblies of plates in TM/TM+AcC/TM+DQ and QT conditions shall be prepared with the weld seam parallel to the plate rolling direction.

The butt weld test assemblies of long products, sections and seamless tubular in any supply condition shall be prepared with the weld seam transverse to the rolling direction.

The bevel preparation should be preferably 1/2V or K.

The welding procedure shall be as far as possible in accordance with the normal welding practice used at the yards for the type of steel in question.

Test report containing the welding procedure specification (WPS) and copies of certificates of welding consumables used for the weld test assemblies preparation shall be submitted to PRS for review.

### 3.7.3 Post-weld Heat Treatment Procedure

Steels supplied in N/NR or TM/TM+AcC/TM+DQ condition shall be heat treated for a minimum time of 1 hour per 25 mm thickness (but not less than 30 minutes and needs not be more than 150 minutes) at a maximum holding temperature of 580°C, unless otherwise approved by PRS.

Steels supplied in QT condition shall be heat treated for a minimum time of 1 hour per 25 mm thickness (but not less than 30 minutes and needs not be more than 150 minutes) at a maximum holding temperature of 550°C with the maximum holding temperature of at least 30°C below the previous tempering temperature, unless otherwise approved by PRS.

Heating and cooling above 300°C shall be carried out in a controlled manner in order to heat/cool the material uniformly. The cooling rate from the maximum holding temperature to 300°C shall not be slower than 55°C/h.

### 3.7.4 Types of Tests

From the test assemblies, the following test specimens shall be taken:

- .1 1 cross weld tensile test specimen (1 full thickness test sample or sub-sized samples covering the full thickness cross section);
- .2 a set of 3 Charpy V-notch impact test specimens transverse to the weld and 1-2 mm below the surface with the notch located at the fusion line and at a distance 2, 5 and minimum 20 mm from the straight fusion line. An additional set of 3 specimens at root is required for each aforementioned position for plate thickness  $t \geq 50$  mm. The fusion boundary shall be identified by etching the specimens with a suitable reagent. The test temperature shall be the one prescribed for the testing of the steel grade in question;
- .3 hardness tests HV10 across the weldment. The indentations shall be made along a 1–2 mm transverse line beneath the plate surface on both the face side and the root side of the weld as follows:
  - fusion line,
  - HAZ: at each 0.7 mm from fusion line into unaffected parent material (minimum 6 to 7 measurements for each HAZ).

The maximum hardness value shall be not higher than:

- 350 HV for steels with strength level 420 and 460 MPa,
- 420 HV for steels with strength level 500, 550, 620 and 690 MPa,
- 450 HV for steels with strength level 890 and 960 MPa.

A sketch of the weld joint depicting groove dimensions, number of passes, hardness indentations shall be attached to the test report, together with photomicrographs of the weld cross-section.

- .4 CTOD test specimens shall be taken from butt weld test assembly specified in 3.7.1.1.2 or 3.7.1.2.2. CTOD test shall be performed in accordance with EN ISO 15653 or equivalent standard.

- the specimen geometry ( $B=W$ ) is permitted for plate thickness up to 50 mm. For plate thicker than 50 mm, subsidiary specimen geometry (50×50 mm) is permitted, which shall be taken 50 mm in depth through thickness from the subsurface and 50 mm in width. See Figure 3.7.4-1 for more details;
- the specimens shall be notched in through thickness direction,
- grain-coarsened HAZ (GCHAZ) shall be targeted for the sampling position of the crack tip,
- the test specimens shall be in as-welded and post-weld heat treated conditions, if applicable,
- three tests shall be performed at  $-10^{\circ}\text{C}$  on each butt weld assembly.

For strength level 690 MPa and above, dehydrogenation of as-welded test pieces may be carried out by a low temperature heat treatment, prior to CTOD test. Heat treatment conditions of  $200^{\circ}\text{C}$  for 4 h are recommended, and the exact parameters shall be noted with the CTOD test results.

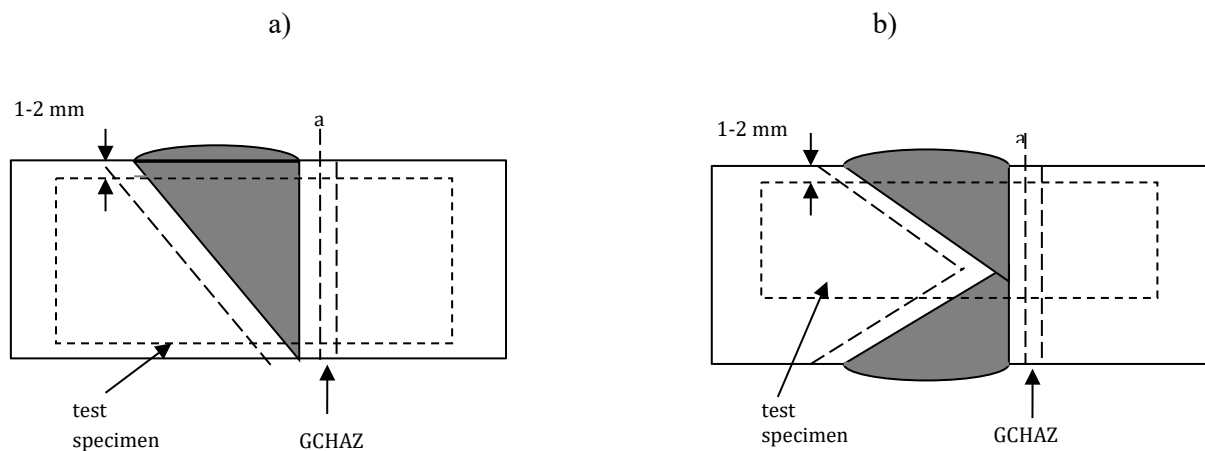

Fig. 3.7.4

- a) for plate thickness  $t \leq 50$  mm, CTOD test specimen shall be sampled in full thickness
- b) for plate thickness  $t > 50$  mm, subsidiary test specimen with a thickness of maximum 50 mm in subsurface area shall be sampled

### 3.7.5 Crack Susceptibility Test

Crack susceptibility test (hydrogen crack test) shall be performed in accordance with recognized national or international standard, e.g. GB/T4675 or JIS Z 3158 for Y-groove weld crack test. Minimum preheat temperature shall be determined and the relationship of minimum preheat temperature with thickness shall be derived.

### 3.7.6 Other Tests

For newly developed types of steel not covered by Chapter 4, this *Part*, additional tests may be required by PRS.

## 4 Results

All required information, specified in Chapter 2 of this *Appendix*, applicable to the products subjected to the tests, shall be collected by the manufacturer and put in reports which will include all the results of the tests and operation records relevant to steel making, casting, rolling and heat treatment of the test products.

These reports shall be submitted to PRS. Depending on the test results, particular limitations or testing conditions, as deemed appropriate, may be specified in the *Approval Certificate*.



## 5 Approval

If the results of the inspection and approval tests are satisfactory, PRS will issue *Approval Certificate*.

## 6 Renewal of Approval

The validity of *Approval Certificate* shall be a maximum of three years. Renewal of approval can be performed at the manufacturer's request, which shall be submitted before the expiry date of the approval validity and after conducting inspection confirming that the approval conditions are complied with.

Manufacturers who have not produced the approved grades and products during the period between renewals may be required to either carry out approval tests or, on the basis of results of production of similar grades of products, at the discretion of PRS, be reapproved.

Where, for operational reasons, the renewal audit falls beyond the period of approval, the manufacturer will still be considered as approved if agreement to this audit date is made within *Approval Certificate* validity. In such case, upon satisfactory renewal audit, PRS extends the *Approval Certificate* with validity from the original renewal date.

## 7 Withdrawal of Approval

PRS may withdraw the approval in the following cases:

- .1 in service failures, traceable to the product quality,
- .2 non-conformity of the product revealed during fabrication or construction,
- .3 discovered failures of the manufacturer's quality system,
- .4 changes made by the manufacturer, without the prior agreement with PRS, to the approval extent specified in the *Approval Certificate*,
- .5 major non-conformities (discovered at testing the products).

**Appendix F****Approval Procedure for Manufacturer of YP47 Steels****1 Scope**

**1.1** Appendix F specifies (as provided in paragraph 3.2.1, this Part) the procedure for the approval of the manufacturing process of YP47 steels.

**1.2** Unless otherwise specified in this Appendix, Appendix A2 shall be followed.

**2 Approval Tests****2.1 Extent of the Approval Tests**

Paragraphs 3.1.3 and 3.1.4 of Appendix A2 are not applied to approval of manufacturer of YP47 steels.

The products for testing are to represent the maximum thickness for approval. If the target chemical composition changes with the thickness, the maximum thickness for each specified chemical composition shall be tested.

**2.2 Type of Tests****2.2.1 Brittle Fracture Initiation Test**

Deep notch test or Crack Tip Opening Displacement (CTOD) test shall be carried out. Test method shall be agreed with PRS.

**2.2.2 Weldability test****2.2.2.1 Y-groove Weld Cracking Test (Hydrogen Crack Test)**

The test method shall be in accordance with recognized national standards such as [ISO 17642-2:2005](#). Acceptance criteria shall be agreed with PRS.

**2.2.2.2 Brittle Fracture Initiation Test**

Deep notch test of CTOD test shall be carried out. Test method and results shall be considered appropriate by PRS.

**2.2.3 Other Tests**

In addition to the requirements specified in 2.2.1 and 2.2.2 of this Appendix, the approval tests required for steels specified in *Appendix A2* shall be carried out. Additional tests may be required when deemed necessary by PRS.

## Appendix G

### Approval Procedure for Manufacturer of Brittle Crack Arrest Steels

#### 1 Scope

1.1 Appendix G specifies (as provided in paragraph 3.2.1, this *Part*) the procedure for the approval of the manufacturing process of brittle crack arrest steels.

1.2 Unless otherwise specified in this Appendix, Appendix A2 and/or Appendix F shall be followed.

#### 2 Approval Application

##### 2.1 Documents to be submitted

The manufacturer shall submit to PRS the following documents together with those required in Appendix A2:

- .1 In-house test reports of the brittle crack arrest properties of the steels intended for approval,
- .2 Approval test program for the brittle crack arrest properties (see 3.1 of this Appendix),
- .3 Production test procedures for the brittle crack arrest properties.

#### 3 Approval Tests

##### 3.1 Extent of the Approval Tests

3.1.1 The extent of the test program is specified in 3.2, 3.3 and 3.4 of this Appendix. If the manufacturing process and mechanism to ensure the brittle crack arrest properties for the steels intended for approval are same, paragraph 3.1 of Appendix A2 shall be followed for the extent of the approval tests. For YP47 steels with brittle crack arrest properties, paragraphs 3.1.3 and 3.1.4 of Appendix A2 are not applied.

3.1.2 The products for testing are to represent the maximum thickness for approval. If the target chemical composition changes with the thickness, the maximum thickness for each specified chemical composition specification shall be tested.

3.1.3 The number of test samples and test specimens may be increased when deemed necessary by PRS, based on the in-house test reports of the brittle crack arrest properties of the steels intended for approval specified in 2.1.1.

##### 3.2 Type of Tests

3.2.1 Brittle crack arrest tests shall be carried out in accordance with 3.3 of this Appendix in addition to the approval tests specified in Appendix A2 and/or Appendix F.

3.2.2 In the case of applying for addition of the specified brittle crack arrest properties for YP36, YP40 and YP47 steels of which manufacturing process has been approved by PRS (i.e. the aim analyses and method of manufacture are similar and the steelmaking process, deoxidation and fine grain practice, casting method and supply condition are the same), brittle crack arrest tests, chemical analyses, tensile test and Charpy V-notch impact test shall be carried out in accordance with this Appendix and Appendix A2.

### 3.3 Test Specimens and Testing Procedure of Brittle Crack Arrest Tests

**3.3.1** The test specimens of the brittle crack arrest tests shall be taken with their longitudinal axis parallel to the final rolling direction of the test plates.

**3.3.2** The loading direction of brittle crack tests shall be parallel to the final rolling direction of the test plates.

**3.3.3** The thickness of the test specimens of the brittle crack arrest tests shall be the full thickness of the test plates.

**3.3.4** The tests specimens and repeat test specimens shall be taken from the same steel plate. Where the brittle crack arrest properties are evaluated by  $K_{ca}$ , and the brittle crack arrest test result fails to meet the requirement, further brittle crack arrest tests may be carried out. In this case, the judgment of acceptance shall be made on the arrest toughness value  $K_{ca}$  of all test specimens (results of the initial tests, failed tests and additional tests shall be included in the testing report).

**3.3.5** The thickness of the test specimen shall be the maximum thickness of the steel plate requested for approval.

**3.3.6** In the case where the brittle crack arrest properties are evaluated by  $K_{ca}$ , the brittle crack arrest test method shall be in accordance with IACS UR W31 Annex 3. In the case where the brittle crack arrest properties are evaluated by CAT, the test method shall be in accordance with IACS UR W31 Annex 4.

### 3.4 Other Tests

Additional tests may be required when deemed necessary by PRS in addition to the tests specified in 3.3 of this Appendix.

## 4 Results

Appendix A2 shall be followed for the results.

Additionally, results of test items and the procedures shall comply with the test program approved by PRS. In the case where the brittle crack arrest properties are evaluated by  $K_{ca}$  or CAT, the manufacturer shall also submit to PRS the brittle crack arrest test reports in accordance with IACS UR W31 Annex 3 for  $K_{ca}$  and IACS UR W31 Annex 4 for CAT.

## 5 Approval and Certification

Upon satisfactory completion of the survey and test, approval is granted by PRS with the grade designation including the suffix “BCA1” or “BCA2” (e.g. EH40-BCA1, EH47-BCA1, EH47-BCA2, etc.).

## 6 Renewal of Approval

The manufacturer shall also submit to PRS actual manufacturing records of the approved brittle crack arrest steels within the term of the validity of the *Approval Certificate*.

*Note:* Chemical composition, mechanical properties, brittle crack arrest properties (e.g. brittle crack arrest test results or small-scale CAT test results) and nominal thicknesses shall be described in the form of histogram or statistics.

**List of amendments effective as of 1 July 2024**

<i>Item</i>	<i>Title/Subject</i>	<i>Source</i>
<a href="#">3.16.4.3</a>	Material Specifications for Brittle Crack Arrest Steels	IACS UR W31 Rev. 3 May 2023
<a href="#">13.1.6.3</a> , <a href="#">13.1.6.4</a> , <a href="#">13.1.6.5</a> , <a href="#">13.1.6.6</a> , <a href="#">13.1.7.2</a>	Steel Castings – Mechanical Tests	IACS UR W8 Rev. 4 May 2024
<a href="#">Appendix F 2.1</a> , <a href="#">2.2.2.1</a>	Approval Procedure for Manufacturer of YP47 Steels	IACS UR W31 Rev. 3 May 2023
<a href="#">Appendix G 3.1.1</a> , <a href="#">3.1.2</a> , <a href="#">3.1.3</a> , <a href="#">3.2.2</a> , <a href="#">3.3.4</a>	Approval Procedure for Manufacturer of Brittle Crack Arrest Steels	IACS UR W31 Rev. 3 May 2023