



**RULES
FOR THE CLASSIFICATION AND CONSTRUCTION
OF INLAND WATERWAYS VESSELS**

**PART IV
STABILITY AND FREEBOARD**

July
2019

GDAŃSK

RULES FOR CLASSIFICATION AND CONSTRUCTION OF INLAND WATERWAYS VESSELS developed and published by Polish Register of Shipping PLC, hereinafter referred to as PRS, consist of the following Parts:

- Part I – Classification Regulations
- Part II – Hull
- Part III – Hull Equipment
- Part IV – Stability and Freeboard
- Part V – Fire Protection
- Part VI – Machinery and Piping Systems
- Part VII – Electrical Equipment and Automation,

whereas for the materials and welding the requirements specified in *Part IX – Materials and Welding*, of the *Rules for Classification and Construction of Sea-going Ships* shall be fulfilled.

Part IV – Stability and Freeboard – July 2019, was approved by PRS Executive Board on 14 June 2019, and comes into force on 1 July 2019.

Upon the entry into force of this *Part IV*, its requirements apply to new vessels in the full scope.

For the existing vessels, the requirements specified in the *Rules* being in force during their construction remain applicable, unless the subsequent editions of the *Rules* or amendments thereto provide otherwise.

The requirements of *Part IV – Stability and Subdivision* are extended and supplemented by the following Publications:

- Publication No. 6/P – Stability,
- Publication No. 14/P – Principles of Approval of Computer Programs,
- Publication No. 66/P – Onboard Computers for Stability Calculations,
- Publication No. 76/P – Stability, Subdivision and Freeboard of Passenger Ships Engaged on Domestic Voyages.
- Publication No. 92/P – Specific Requirements for Inland Waterways High-Speed Vessels.

© Copyright by Polish Register of Shipping*, 2022

* *Polish Register of Shipping* means *Polski Rejestr Statków S.A.*, seated in Gdańsk, al. gen. Józefa Hallera 126, 80-416 Gdańsk, Poland, registered in the Register of Entrepreneurs of the National Court Register, under entry number 0000019880. Polish Register of Shipping, its affiliates and subsidiaries, their respective officers, employees or agents are, individually and collectively, referred to as Polish Register of Shipping or as PRS for short.

CONTENTS

	Page
1 General	5
1.1 Application	5
1.2 Definitions and Symbols.....	5
1.3 Scope of Survey	9
1.4 General Requirements	9
2 Stability – Basic Requirements and Criteria	11
2.1 Typical Loading Conditions	11
2.2 Stability Criteria	11
3 Stability – Specific Requirements for Different Types of Vessels and Floating Establishments..	16
3.1 Passenger Vessels.....	16
3.2 Passenger Sailing Vessels	19
3.3 Vessels Carrying Not More than 12 Passengers	19
3.4 Ferries	19
3.5 Cargo Vessels Carrying other Cargoes than Containers.....	20
3.6 Vessels Carrying Non-secured Containers.....	20
3.7 Cargo Vessels Carrying Secured Containers.....	22
3.8 Tugs	22
3.9 Ice-breakers.....	23
3.10 Pushing vessels.....	23
3.11 Fire-fighting Vessels	23
3.12 Floating Cranes	23
3.13 Dredgers.....	23
3.14 Pontoons.....	24
3.15 Floating Restaurants	24
3.16 Floating Platforms	24
3.17 Pile Drivers	24
3.18 Floating Scaffoldings	25
3.19 Vessels Carrying Dangerous Goods	25
4 Subdivision	25
4.1 General Requirements	25
4.2 Specific Requirements for Particular Types of Vessels	26
5 Freeboard	30
5.1 Application	30
5.2 General Provisions.....	30
5.3 Scope of Survey	31
5.4 Freeboard Assignment.....	31
5.5 Freeboard Marking	34
5.6 Freeboard Assignment Conditions	36
Annex 1 – Requirements for Stability and Subdivision of Vessels Carrying Dangerous Goods (acc. to ADN).....	35
Annex 2 – Simplified Methods of Stability Calculation.....	43

1 GENERAL

1.1 Application

1.1.1 This *Part IV – Stability and Freeboard*, of the *Rules for the Classification and Construction of Inland Waterways Vessels* (hereinafter referred to as the *Rules*) applies to the vessels and floating establishments specified in paragraph 1.1.1 of *Part I – Classification Regulations* which are engaged on voyages on inland waterways.

1.1.2 Passenger vessels also engaged on voyages in waters considered as sea areas shall additionally fulfil the requirements of European Parliament and Council Directive 2009/45/EC of 6 May 2009 (see *Publication No. 76/P – Stability, Subdivision and Freeboard of Passenger Ships Engaged on Domestic Voyages – 2006*).

1.1.3 The requirements concerning stability and subdivision of high-speed craft are subject to PRS agreement in each particular case, taking into account requirements given in *Publication No. 92/P – Specific Requirements for Inland Waterways High-Speed Vessels*.

1.1.4 The requirements specified in this *Part IV* may be replaced by other stability and subdivision requirements provided they have been recognised by the flag State Administration.

1.1.5 The existing vessels and floating establishments shall fulfil the requirements specified in this Part of the *Rules* according to the provisions of Administrations.

1.2 Definitions and Symbols

Definitions relating to the general terminology of the *Rules for Classification and Construction of Inland Waterways Vessels* (hereinafter referred to as the *Rules*) are contained in *Part I – Classification Regulations*. In this sub-chapter, the definitions, symbols and abbreviations, specific to *Part IV* are provided.

After perpendicular – the perpendicular within vessel's symmetry plane at the axis of the rudder stock. For vessels with unconventional stem curvature, the position of the after perpendicular is subject to PRS consent in each particular case.

Allowable angle of heel – the minimum angle of heel determined in accordance with the general criteria or with the criteria specific to the particular type of vessel.

Angle of bilge emergence – angle of heel for which the bilge or the line of intersection of the outer edge of side-bottom in the midlength of vessel emerges above the navigating waterline at the loading condition under consideration.

Angle of deck downflooding – the minimum angle at which the lowest deck edge is immersed.

Angle of heel – angle between y axis of the vessel's co-ordinate system and the navigating waterline at the assumption that the vessel is heeled in $y - z$ plane only.

Angle of heel due to gust – dynamic angle of heel due to gust (squall).

Angle of static stability range – angle of heel for which the static stability righting lever of the heeled vessel is equal to zero.

Angle of trim – angle between x axis of the vessel's co-ordinate system and the navigating waterline at the assumption that the vessel is trimmed in $x - z$ plane only.

Angle of vessel downflooding – the minimum value of heel angles at which the vessel interior is flooded by outboard water through openings in the hull, deck, deckhouses or superstructures considered to be open.

Base plane – horizontal plane which crosses amidships the top of a flat keel or the intersection of the inner surface of the plating with the bar keel.

Breadth of vessel, B – the greatest breadth of the vessel between the outer edges of frames – in a vessel with metal shell plating or between the outer surfaces of the hull – in vessels with shell plating of any other material.

Bulkhead deck – the uppermost deck up to which transverse watertight bulkheads are carried.

Co-ordinate system – the right-handed co-ordinate system x, y and z where axes x, y are co-planar with the base plane (B.P.) and axes y, z are co-planar with the midship section. The intersection of the base plane, midship section and longitudinal centre plane determines the origin of coordinates named K which is the point of reference for the calculated hydrostatic and stability characteristics.

For the purposes of this part of the *Rules*, the adopted stability criteria apply to the two-dimensional stability analysed in the transverse plane parallel with the midship section where the vessel's centre of buoyancy is located.

The co-ordinate system adopted as well as vectors of forces and moments are shown in Fig. 1.2.

In stability calculations, the reference system may be transformed by moving the origin of the co-ordinate system to the after perpendicular (A.P.) or elsewhere depending on the co-ordinate system adopted in the documentation.

In stability calculations for typical vessels, constant values of static moments due to the external forces acting on the vessel shall be assumed irrespective of the angle of heel or the angle of trim.

Critical angle of heel – the smaller angle out of the downflooding or capsizing angles.

Deck line – the line of intersection of the outer edge of freeboard deck with the shell plating.

Draught, T – vertical distance measured amidships from the base plane to the maximum load waterline.

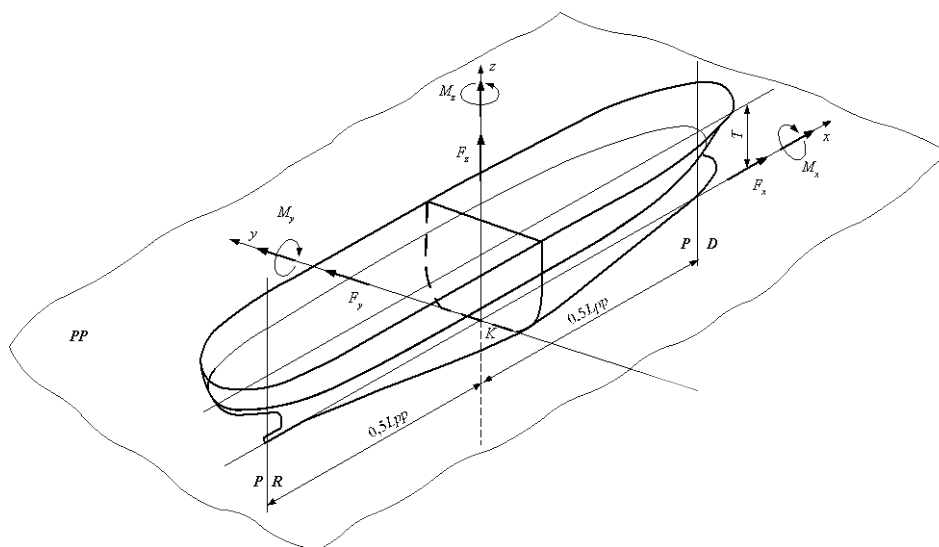

Fig. 1.2 Vessel's co-ordinate system

Dynamic angle of heel, φ_d – instantaneous angle achieved by the vessel induced by an external moment resulting from the energy equation for the system where the heeling moment work is equal to the righting moment work.

Floating equipment – a floating installation carrying working gear such as cranes, dredging equipment, pile drivers or elevators.

Forward perpendicular – the perpendicular in vessel's symmetry plane at the intersection of the maximum draught waterline with the fore side of the stem. For vessels with unconventional stem curvature, the position of the forward perpendicular is subject to PRS consent in each particular case.

Freeboard – the distance between the plane of maximum draught and a parallel plane passing through the lowest point of the gunwale, the lowest point of the upper edge of the vessel's deck.

Freeboard deck – the uppermost complete deck which has permanent means of closing all openings in the weather part thereof, and below which all openings in the sides of the ship are fitted with permanent means of weathertight closing.

Free surfaces – surfaces of all liquids, such as liquid cargo, stores and rain water, sloshing in the event of heeling over taken into account in the specific loading condition.

Heeling moment – moment due to the forces acting in the vessel's transverse plane which heels the vessel.

Heeling moment due to wind, M_w – a conventional design moment caused by dynamic action of the wind.

High speed craft – a power driven vessel, capable of reaching the speed exceeding 40 km/h with respect to water.

Length between perpendiculars, L_{pp} – the distance between the fore and aft perpendiculars.

Length of vessel, L_k – the maximum length of the vessel's hull (exclusive of the rudder, bowsprit and fenders).

Length on waterline, L_{WL} – the maximum length of the vessel's hull measured at the waterline in the maximum loading condition.

Light vessel – vessel ready for operation, but without cargo, stores, ballast water, passengers, crew and their effects.

Margin line – the line drawn not less than 100 mm below the upper surface of the bulkhead deck at side and not less than 100 mm below the lowest non-watertight point in the side plating. Where there is no bulkhead deck, a line drawn not less than 100 mm below the lowest line up to which the outer plating is watertight shall be adopted.

Moulded depth, H – vertical distance measured amidships from the base plane to the lower edge of the uppermost continuous deck at the side of the vessel. In vessels having a rounded gunwale, the moulded depth is measured to the point of intersection of the moulded lines of the deck and side.

If the uppermost continuous deck is stepped and the raised part of the deck extends over the point at which the moulded depth is determined, the moulded depth is measured to a line of reference extending from the lower part of the deck along a line parallel with the raised part.

Moulded displacement, D – mass of water, in tonnes, of the volume equal to the volume of the submerged part of the ship's hull at draught T .

Openings considered to be open – openings in the upper deck or decks and bulkheads of superstructures and deckhouses whose closing arrangements do not protect (in respect of tightness, strength and reliable operation) the vessel's spaces against being flooded by outboard water. When analysing intact stability, these are any openings without weathertight means of closing. When analysing damage stability, these are any openings without watertight means of closing. Such openings include air pipes and these which are capable of being closed by means of weathertight doors or hatch covers and may exclude those openings closed by means of watertight manhole covers and flush scuttles, small watertight cargo tank hatch covers which maintain high integrity of the deck, remotely-operated watertight sliding doors and side scuttles of the non-opening type.

Passenger vessel – vessel intended to carry more than 12 passengers.

Permeability of space – ratio of the volume which can be occupied by water to the whole volume of the space. Permeability of space may be reduced by permanent filling such space with an approved non-absorbable floatation material.

Plane of maximum draught – water plane corresponding to the maximum draught at which the vessel is authorised to navigate.

Residual freeboard – vertical clearance available, in the event of heeling over, between the water level and the upper surface of the deck at the lowest point of the deck or, if there is no deck, the lowest point of the upper surface of the fixed vessel's side at the immersed side.

Residual safety clearance – the vertical clearance available in the event of the vessel's heeling over, between the water level and the lowest point of the immersed side, beyond which the vessel is no longer considered as watertight.

Safety clearance – the minimum distance, measured vertically, between the water level and the parallel plane passing through the lowest point above which the vessel is no longer deemed to be watertight, taking vessels trim into account.

Weathertight – the term pertaining to closing appliances and covers for openings in deck or superstructures which prevent the penetration of water spray into the vessel in any navigating conditions in the appropriate service area; minor leak is acceptable.

Static stability levers' curve, GZ – curve representing the dependence between the righting lever and angle of heel.

Stores – oil fuel, fresh water, provisions, lubricating oil, consumables.

Transverse stability of vessel – vessel's stability analysed in the transverse plane $y - z$ only.

Trimming moment – moment caused by forces acting in the vessel's longitudinal plane which trims the vessel.

Watertightness – the term pertaining to closing of openings, which means that water will not penetrate through these openings in any direction under a design head. The design head shall be determined by reference to the bulkhead deck or freeboard deck, as applicable, or to the most unfavourable equilibrium/intermediate waterline, in accordance with the applicable subdivision and damage stability requirements, whichever is the greater.

Weathertightness – the term pertaining to closing appliances of openings in the above water part of a ship, which means that in any sea condition water will not penetrate through these openings. (Such closing appliances are to withstand a hose test in which the nozzle outlet is at least 16 mm in diameter and the pressure ensures to eject water upwards for at least 10 m in height; the distance from the nozzle to the tested member is to be not more than 3 metres).

Windage area, F_w – area of the projection of the above-water part of vessel onto $x - z$ plane. For openwork elements, the windage area is taken as the area of the particular element outline projection onto $x - z$ plane multiplied by the filling factor.

1.3 Scope of Survey

1.3.1 General rules for classification, survey of the construction, class surveys and documentation to be submitted to PRS for approval are specified in Part I – *Classification Regulations*.

1.3.2 Prior to commencement of the vessel's construction, the following shall be submitted to PRS Head Office:

- design stability analysis based on theoretical mass calculations and centres of gravity;
- damage stability calculations, if required.

1.3.3 Upon completion of the vessel's construction or alteration, the following activities shall be done:

- inclining test shall be performed in the presence of PRS surveyor to determine the vessel's mass and the co-ordinates of its centre of gravity;
- final *Stability Booklet* shall be submitted to PRS for approval.

PRS may waive the requirement of stability calculations for the floating establishment if the tests with the working load prove that the stability and freeboard ensure its safe service.

1.3.4 The scope of the vessel's periodical surveys by PRS covers the following:

- validity check of the *Stability Booklet* and *Information on Damage Stability* (where required);
- checking compliance with the requirements concerning the hull watertight integrity.

1.4 General Requirements

1.4.1 General Assumptions and Principles

1.4.1.1 Each vessel or floating establishment shall carry the *Stability Booklet* approved by PRS. Where the vessel or floating establishment is exempt from the requirement to carry the *Stability Booklet*, an appropriate record is entered in the classification documents of such a vessel or floating establishment. The *Stability Booklet* and enclosures thereto shall be submitted to PRS in quadruplicate.

1.4.1.2 Stability booklet should contain:

- .1 general arrangement plan;
- .2 the ship's identification data as name of the ship, type of ship, shipyard, No. of build, date of build (alteration), the main dimensions, number of crew, number of passengers, deadweight, navigation area, symbol of class, flag, port of registry, IMO number;
- .3 data on the ship's stability in loading conditions required by the Rules and in operating conditions specified by the Owner;
- .4 guidance for the master;
- .5 necessary additions, as plan of the ship indicating the arrangement of passengers, carried vehicles, stores, permanent ballast, where provided.

1.4.1.3 For vessels or floating establishments which are subject to the requirements specified in Chapter 4, the *Information on Damage Stability* shall be additionally prepared and submitted to PRS for approval.

1.4.1.4 Wherever a vessel is mentioned in this part of the *Rules*, such a requirement also applies to floating establishments unless stated otherwise.

1.4.2 Calculation Methods

1.4.2.1 Hydrostatic and stability calculations shall be performed in accordance with the methods common to naval architecture. It is recommended that the calculations be performed using programs approved by PRS in accordance with *Publication No. 14/P – Principles of Approval of Computer Programs*.

PRS may accept the results of calculations made using a program not approved by PRS on condition that such results prove to be correct by calculations made by PRS covering the full scope of the submitted calculations.

1.4.2.2 Volumetric capacity of superstructures and deckhouses which are provided with weathertight external openings towards both sides or higher deck or are provided with an emergency exit may be taken into account in hydrostatic and stability calculations.

1.4.2.3 Hydrostatic and stability calculations shall be performed for waterlines parallel with the load waterline. If, however, the vessel's trim relative to its length, L_k , exceeds 0.02, calculations shall be made for waterlines parallel with the current load waterline.

1.4.3 Effect of Free Surfaces of Liquids

1.4.3.1 Free surfaces of liquids in tanks (stores and liquid cargo) as well as water on the cargo hold bottom or in deck niches if its level exceeds 0.05 m shall be taken into account in the stability calculations.

1.4.4 Stability of Series-constructed Vessels

1.4.4.1 In the case of series-constructed vessels for which stability calculations are required, the centre of gravity shall be determined by inclining for the first vessel constructed in the particular shipyard, whereas for passenger vessels – for every fifth vessel counting from the last vessel for which the inclining test was performed. For other vessels of the same series, it may be assumed that the centre of gravity is in the same point as in the recently tested vessel.

1.4.4.2 Every fifth vessel shall be subjected to lightweight check to compare its mass with that of the prototype.

Where the mass of the subsequent vessel differs by more than 2% from the mass of the vessel subjected to the inclining test, a new inclining test shall be performed for the vessel in question.

1.4.5 Inclining Test

1.4.5.1 Inclining test shall be performed for each newly-built vessel, and for series-constructed vessels in accordance with the requirements specified in paragraph 1.4.4.1.

1.4.5.2 Inclining test shall be performed in accordance with the requirements specified in *Publication No. 6/P – Stability* and witnessed by PRS Surveyor.

1.4.5.3 At the request of the designer or Owner, PRS may exempt the vessel from the inclining test provided that the lightweight check has been performed and it has been demonstrated that vessel fulfils the requirements specified in this part of the *Rules* for the height of the centre of mass of a light vessel greater than the design height by 20%. The inclining test may also be waived for the vessel for which explicitly greater height of the centre of mass was assumed.

1.4.6 Inclining Test Check

1.4.6.1 In the event of alteration, repair or re-fit, the inclining test shall be performed for these vessels on which the changes result in any of the following:

- .1 change in mass (combined deducted and added masses) above 6% of the lightweight vessel,
- .2 change in lightweight by more than 2%, or
- .3 rising of the height of the lightweight centre of mass by more than 4 cm or by more than 2% (whichever is lesser),
- .4 change of the longitudinal position of the lightweight centre of mass by more than 1% L_k .

1.4.7 Departures from *Rules*

1.4.7.1 At the request of the designer or Owner, PRS may grant exemptions from the requirements specified in this part of the *Rules* for vessels:

- .1 not carrying passengers and engaged on voyages on inland waterways which have no connection with inland waterways of another EU member state;
- .2 engaged on voyages on restricted domestic inland waterways.

1.4.7.2 Applied exemption shall not reduce the vessel's stability and requires consent by the Flag State Administration who is obliged to notify the European Commission on the exemption applied to the particular vessel.

1.4.8 Permissible Simplification of Calculations

1.4.8.1 In stability calculations of vessels whose capacity of the above-water part is so distributed that significant trim does not occur at the heel condition, the simplifications specified in *Annex 2* may be adopted.

2 STABILITY - BASIC REQUIREMENTS AND CRITERIA

2.1 Typical Loading Conditions

2.1.1 Unless required otherwise in specific provisions, stability calculations shall be performed for the following loading conditions:

- light vessel,
- light vessel, crew, 10% stores,
- light vessel, crew, 100% stores,
- full loading condition, crew, 100% stores,
- full loading condition, crew, 10% stores.

2.1.2 For specific vessels, stability calculations may be required for other and/or additional loading conditions. These conditions are subject to PRS agreement in each particular case.

2.1.3 Where other loading conditions are expected during normal service, more adverse than those specified in paragraph 2.1.1 or sub-chapter 3.1, the vessel's stability shall also be checked for each of those loading conditions.

2.2 Stability Criteria

2.2.1 Each vessel engaged on voyages on inland waterways shall fulfil the general stability criteria specified in sub-chapters 2.2.2 to 2.2.7 for each of the considered loading conditions.

2.2.2 Weather Criterion

2.2.2.1 Stability of vessels, or floating establishments, in respect of the weather criterion is considered sufficient if in all expected loading conditions the dynamic heeling moment due to wind, M_w , (taking into consideration the requirements of 2.2.2.5), does not exceed the capsizing moment, M_{kr} , i.e. the following relation is fulfilled:

$$K = \frac{M_{kr}}{M_w} \geq 1 \quad (2.2.2.1)$$

where:

K – weather criterion factor.

2.2.2.2 Heeling moment due to dynamic action of wind, M_w , shall be considered as a constant value (i.e. not related with the vessel's heel) and calculated in accordance with the following formula:

$$M_w = q \cdot F_w \cdot Z, \quad [\text{kNm}] \quad (2.2.2.2)$$

where:

q – dynamic pressure by wind [kPa],

F_w – windage area of the projection of the above-water part of vessel onto the centre plane [m²],

Z – distance from the centre of windage area, F_w , to the current waterline plane [m].

Dynamic wind pressure, q , shall be taken as follows:

$q = 0.3$ kPa for vessels with operating area mark **1** or **2** and floating cranes with operating area mark **3**;

$q = 0.2$ kPa for vessels with operating area mark **3**;

$q = 0.6$ kPa floating cranes with operating area mark **1** or **2**.

In the calculations of lateral windage area, expected area of tarpaulin to be spread and portable equipment on the deck shall be taken into account.

2.2.2.3 The applied method for determining the capsizing moment, M_{kr} , is subject to PRS acceptance in each particular case. The recommended method for determining the capsizing moment is presented in *Publication No. 6/P – Stability*.

2.2.2.4 Windage area, F_w , consisting of non-continuous elements (e.g. openwork) shall be calculated taking into account filling factors specified in Table 2.2.2.4.

Table 2.2.2.4

Type of structure	Filling factor, k
bulwark rails, handrails	0.2
wire mesh guards on bulwark rails	0.6
openwork	0.3 ÷ 0.5

2.2.2.5 For ships having operating area mark 1 and ships having operating area marks 2 and 3 which are permitted to operate in area 1 in restricted weather conditions, when calculating the weather criterion the amplitude of rolling shall be considered, as shown in 2.2.3.

2.2.3 Calculation of the Amplitude of Rolling

2.2.3.1 The amplitude of rolling θ_a for hulls with round bilge (bilge keels not considered) shall be determined from Table 2.2.3.1, on the basis of rolling frequency m (s⁻¹) calculated in accordance with formula:

$$m = m_1 \cdot m_2 \cdot m_3 \quad (2.2.3.1)$$

Table 2.2.3.1

m, [s ⁻¹]	Amplitude of rolling θ_a [degrees]	
	Operating area	
	1	2 and 3 *
0.40	9	5
0.60	10	5
0.80	13	6
1.00	17	8
1.20	20	10
1.40	23	13
1.60	24	15
1.80	24	16

* for vessels operating in areas 2 or 3 permitted to operate in area 1 in restricted weather conditions

2.2.3.2 The amplitude of rolling for vessels with sharp bilge may be taken as equal to 0.80 of the value calculated in accordance with Table 2.2.3.1.

2.2.3.3 The natural oscillation frequency coefficient m_1 , [s⁻¹] for a vessel (in still water) shall be calculated from the below formula:

$$m_1 = m_0 / \sqrt{GM_0} \quad (2.2.3.3-1)$$

where:

GM_0 – metacentric height (without correction for free surfaces effect) in the given loading condition, [m],

m_0 – coefficient determined from Table 2.2.3.3 on the basis of parameter n_1

$$n_1 = (GM_0 / \sqrt[3]{V}) / (KG_0 / B) \quad (2.2.3.3-2)$$

where:

V – displacement [m³] for the given loading condition,

KG_0 – height of vessel's mass centre in the given loading condition (without correction for free surfaces) [m],

B – breadth of the vessel for the considered waterline [m].

Table 2.2.3.3

n_1	m_0
≤ 0.10	0.42
0.15	0.52
0.25	0.78
0.50	1.38
0.75	1.94
1.00	2.40
1.50	3.00
2.00	3.30
2.50	3.50
≥ 3.00	3.60

2.2.3.4 The values of coefficients m_2 and m_3 taking into account hull shape effect on the amplitude of rolling, shall be determined from Tables 2.2.3.4-1 and 2.2.3.4-2, depending on relation B/T and block coefficient δ

Table 2.2.3.4-1

B/T	m_2
≤ 2.50	1.00
3.00	0.90
3.50	0.81
4.00	0.78
5.00	0.81
6.00	0.87
7.00	0.92
8.00	0.96
9.00	0.99
≥ 10.00	1.00

Table 2.2.3.4-2

δ	m_3	δ	m_3
≤ 0.45	1.00	0.65	0.72
0.50	0.95	0.70	0.69
0.55	0.86	0.75	0.67
0.60	0.77	≥ 0.80	0.66

2.2.3.5 If the vessel has bilge keels or a bar keel, or both, the amplitude of rolling shall be determined from the below formula:

$$\theta_a = k \cdot \theta_a \text{ [degrees]} \tag{2.2.3.5}$$

where:

k – coefficient calculated in accordance with 2.2.3.6

θ_a – rolling amplitude calculated without consideration of keels, [degrees].

2.2.3.6 The k coefficient shall be determined from Table 2.2.3.6, depending on the value of q calculated from the formula:

$$q = r \cdot \alpha \cdot \sqrt{B} \tag{2.2.3.6}$$

where:

B – vessel’s breadth on the actual waterline, [m]

α – block coefficient of actual waterline,

r – coefficient calculated in accordance with 2.2.3.7

Table 2.2.3.6

q	k	q	k
0	1.00	5.00	0.68
1.00	0.95	6.00	0.65
2.00	0.85	7.00	0.63
3.00	0.77	≥ 8.00	0.62
4.00	0.72	-	-

2.2.3.7 The coefficient r shall be calculated from the formula:

$$r = (r_1 + r_2) \cdot r_3 \quad (2.2.3.7)$$

where: r_1, r_2, r_3 – coefficients calculated in accordance with 2.2.3.8

2.2.3.8 The value of coefficient r_1 shall be taken from Table 2.2.3.8, depending on relation F_s/LB ,

where:

F_s – combined area of bilge keels or the area of side view of bar keel, or a sum of these areas, [m²],
 L, B – vessel's length, breadth on the actual waterline, [m].

Table 2.2.3.8

$100 \cdot F_s / LB, [\%]$	r_1	$100 \cdot F_s / LB, [\%]$	r_1
0.70	0.14	2.50	0.94
1.00	0.24	3.00	1.20
1.50	0.44	3.50	1.48
2.00	0.68	≥ 4.00	1.66

2.2.3.9 The coefficients r_2 and r_3 shall be determined from Tables 2.2.3.9-1 and 2.2.3.9-2, depending on the coefficient δ and relation B/T ,

where: T – mean draught to actual waterline, [m],

Table 2.2.3.9-1

δ	r_2
≤ 0.45	0
0.50	0.06
0.55	0.18
0.60	0.35
0.65	0.51
0.70	0.65
0.75	0.71
0.80	0.68
≥ 0.85	0.64

Table 2.2.3.9-2

B/T	r_3
≤ 2.50	1.40
3.00	1.48
4.00	1.58
5.00	1.83
6.00	2.00
7.00	2.13
8.00	2.34
9.00	2.50
≥ 10.00	2.60

2.2.4 Minimum Metacentric Height

2.2.4.1 Minimum metacentric height of the vessel in any loading condition, taking into account free surfaces of liquids (stores, cargo and rain water in cargo holds) shall not be less than 0.15 m ($GM \geq 0.15$ m).

2.2.4.2 For vessels with a length $L_k < 20$ m, the minimum corrected metacentric height shall not be less than 0.30 m ($GM \geq 0.30$ m).

2.2.5 Static Stability Curve

2.2.5.1 Depending on the type of vessel, the static stability curve run shall be in accordance with the requirements specified in Chapter 3.

2.2.6 Icing

For vessels with operating area mark **1**, engaged on voyages in winter, icing shall be taken into account assuming additional mass of ice determined as $7.5 \text{ kg/m}^2 \times \text{windage area}$ and $15 \text{ kg/m}^2 \times \text{deck surface}$. Windage area and the position of its centre shall be determined for T_{min} without an icing allowance.

The centre of ice mass on the lateral surface shall be assumed in the geometric centre of such a surface, and the centre of deck ice mass height – at the level of such a deck.

2.2.7 Vessels covered by requirements of this part of the *Rules* also in respect of subdivision, shall have such intact stability that after the damage and flooding of compartment(s), the damage stability criteria specified in Chapter 4 be fulfilled.

2.2.8 Irrespective of the above subdivision requirements, each vessel shall also fulfil the detailed requirements specified in Chapter 3 for the particular type of vessel.

3 STABILITY – SPECIFIC REQUIREMENTS FOR DIFFERENT TYPES OF VESSELS AND FLOATING ESTABLISHMENTS

3.1 Passenger Vessels

3.1.1 Stability of passenger vessels shall be calculated for the following loading conditions:

- .1 light vessel, crew, no passengers, 10% fuel and drinking water, no sewage;
- .2 at commencement of voyage:
light vessel, crew, 100% passengers, 98% fuel and drinking water, 10% sewage;
- .3 during voyage:
light vessel, crew, 100% passengers, 50% fuel and drinking water, 50% sewage;
- .4 at the end of voyage:
light vessel, crew, 100 % passengers, 10% fuel and drinking water, 98% sewage.

For all loading conditions, it shall be assumed that ballast tanks are empty or full according to their expected usage.

The quantity of water ballast may be changed during the voyage only where for the following loading condition: light vessel, 100% passengers, 50% fuel and drinking water, 50% sewage all tanks for other liquids including ballast tanks filled in 50%, the requirements specified in paragraph 3.1.2 are fulfilled.

3.1.2 Passenger vessel intact stability is considered as sufficient where in each loading condition taken into account the following requirements are fulfilled:

- .1 the maximum static stability righting lever, GZ_{max} , shall not be less than 0.20 m at the angle of heel φ_{max} not less than:
25° – for operating areas **1** and **2**,
 $\varphi_{mom} + 3^\circ$ – for other operating areas,
and shall not be less than 0.20 m.
If downflooding angle φ_z is less than φ_{max} , the righting lever shall not be less than 0.20 m at downflooding angle φ_z ;
- .2 downflooding angle φ_z shall not be less than:
50° – for operating area **1**,
25° – for operating area **2**,
 $\varphi_{mom} + 3^\circ$ – for other operating areas;

- .3 area A under the righting lever curve GZ shall – depending on the angles for which it is calculated (φ_z or φ_{\max}) – have values not less than those specified in Table 3.1.2.3;

Table 3.1.2.3

Item	If	A [mrad]
1	$\varphi_{\max} \leq 15^\circ$ or $\varphi_z \leq 15^\circ$	0.05 mrad up to the smaller angles φ_{\max} or φ_z
2	$15^\circ < \varphi_{\max} < 30^\circ$ and $\varphi_{\max} \leq \varphi_z$	$0.035 + 0.001(30 - \varphi_{\max})$ mrad up to the angle φ_{\max}
3	$15^\circ < \varphi_z < 30^\circ$ and $\varphi_{\max} > \varphi_z$	$0.035 + 0.001(30 - \varphi_z)$ mrad up to the angle φ_z
4	$\varphi_{\max} \geq 30^\circ$ and $\varphi_z \geq 30^\circ$	0.035 mrad up to the angle $\varphi = 30^\circ$

where:

- φ_z – angle of downflooding, i.e. angle of heel at which openings in the hull, superstructure or deckhouse not provided with weathertight closures are submerged;
 φ_{mom} – maximum angle of heel according to conditions given in .4 and .5;
 φ_{\max} – angle of heel at which the maximum righting lever, GZ_{\max} , occurs;
 A – area A under the righting lever curve GZ , [mrad];

- .4 angle of heel resulting from simultaneous action of the heeling moment due to crowding of all passengers towards one side and the heeling moment due to steady wind pressure shall not exceed 12° .

The heeling moment due to crowding of all passengers towards one side shall be calculated in accordance with formula 3.1.3.1.

The heeling moment due to steady wind pressure shall be calculated in accordance with formula 3.1.3.2;

- .5 angle of heel resulting from simultaneous action of the heeling moment due to crowding of all passengers towards one side and the heeling moment due to turning shall not exceed 12° .

The heeling moment due to crowding of all passengers towards one side shall be calculated in accordance with formula 3.1.3.1.

The heeling moment due to turning shall be calculated in accordance with formula 3.1.3.3;

- .6 in any case, freeboard of passenger ship in upright position, should be less than 0.6 m for operating area 1, 0.4 m for area 2 and 0.3 m for area 3 – as well as it should not be less than determined according to the Chapters 4 to 7 of this part of the *Rules*;

- .7 for a heeling moment resulting from moments due to persons, wind and turning according to 3.1.3, the residual freeboard shall be not less than 0.20 m;

- .8 in the case of vessels with non-watertight windows or other openings in hull situated below the bulkhead deck, the residual safety clearance of such openings shall not be less than 0.10 m at the heel resulting from the simultaneous action of three heeling moments calculated in accordance with formulae 3.1.3.1, 3.1.3.2 and 3.1.3.3.

3.1.3 Calculation of Heeling Moments

3.1.3.1 Static heeling moment due to crowding of all passengers towards one side, M_p , shall be calculated in accordance with the following formula:

$$M_p = g \cdot \sum_{i=1}^n P_i \cdot y_i \text{ [kNm]} \quad (3.1.3.1)$$

where:

P_i – mass i of the group of passengers and crew crowded towards one side [t],

Y_i – lateral distance of the centre of mass of the group of passengers and crew from the centre plane [m],



n – number of groups of passengers crowded on one side,
 g – gravitational acceleration ($g = 9.81 \text{ m/s}^2$).

While determining the number of passengers crowded towards one side, the following assumption shall be adopted:

- .1 passengers are located on the uppermost deck and subsequently on the lower open decks and sheltered decks designated for passengers. Passenger cabins shall be treated as unattended;
- .2 concentration of passengers – 3.75 passengers per 1m^2 of free deck surface;
- .3 standing person's centre of mass – 1.00 m above the lowest point of the deck at $0.5 L_{WL}$, ignoring any deck curvature;
- .4 sitting person's centre of mass – 0.30 m above the bench surface;
- .5 mass of one person – 75 kg;
- .6 width of seat occupied by a sitting person – 0.50 m;
- .7 depth of seat occupied by a sitting person – 0.75 m.

The calculation shall be carried out for an accumulation of persons both to starboard and to port.

3.1.3.2 A detailed calculation of deck areas which are occupied by persons may be dispensed with if the following values are used:

$P = 1.1 \cdot F_{max} \cdot 0.075 \cdot y$ – for day trip vessels;

$P = 1.5 \cdot F_{max} \cdot 0.075 \cdot y$ – for cabin vessels;

where:

F_{max} = maximum permitted number of passengers on board;

$y = B/2$ in [m].

3.1.3.3 Static heeling moment due to wind pressure, M_s , shall be calculated in accordance with the following formula:

$$M_s = q_s \cdot F_w \cdot (Z + T/2) \text{ [kPa]} \quad (3.1.3.3)$$

where:

q_s – steady wind heeling pressure 0.25 kPa;

F_w – see paragraph 2.2.2.2;

T – draught in particular loading condition [m];

Z – distance of the centre of gravity of the lateral plane F_w from the plane of draught according to the considered loading condition in [m];

In calculating the lateral plane, account shall be taken of the intended enclosure of the deck by awnings and similar mobile installations.

3.1.3.4 Heeling moment due to turning, M_c , shall be calculated in accordance with the following formula:

$$M_c = 0,45 \cdot C_b \cdot v^2 \cdot \frac{D}{L_{WL}} (KG - T/2) \text{ [kNm]}; \quad (3.1.3.4)$$

where:

C_b – moulded block coefficient (if not known, taken as 1.0);

v – maximum speed of vessel [m/s];

D – vessel's maximum displacement volume in particular loading condition [t];

L_{WL} – length on waterline [m];

KG – height of vessel's centre of mass measured from the base plane (corrected for free surface effects) [m].

3.1.3.5 For passenger vessels with such propulsion systems as rudder-propeller, water-jet propeller, cycloidal propeller and bow thruster, the value of M_c shall be determined through tests performed on either life-size vessels or models or through adequate calculations.

3.2 Passenger Sailing Vessels

3.2.1 Stability of passenger sailing vessels shall be checked for loading conditions specified in paragraph 3.1.1.

3.2.2 Stability of passenger sailing vessels is considered as sufficient if for each of the considered loading conditions the following criteria are fulfilled:

- .1** for a vessel with furled sails, the requirements specified in paragraph 3.1.2 shall be fulfilled;
- .2** for a vessel using a standard arrangement of sails, the heeling moment caused by wind pressure shall not be so high to cause the angle of heel exceeding 20° for a steady wind pressure $q_s = 0.07$ kPa. The residual safety clearance of openings shall not be less than 0.1 m, and the residual freeboard shall be positive;
- .3** the righting lever of static stability, GZ , shall:
 - reach its maximum value at a heeling angle of 25° or over;
 - amount to at least 0.2 m at an angle of heel of 30° and over;
 - be positive at an angle of heel of up to at least 60° ;
- .4** the area under the righting lever curve shall not be less than:
 - 0.055 mrad up to 30°
 - 0.09 mrad up to 40° , or at the angle at which an unprotected opening reaches the water surface and which is less than 40° ,
 - 0.03 mrad between 30° and 40° , or 30° and the angle at which an unprotected opening reaches the water surface and which is less than 40° .

3.3 Vessels Carrying Not More than 12 Passengers

3.3.1 Vessels carrying not more than 12 passengers shall fulfil the following requirements:

- static angle of heel due to crowding of all passengers towards one side and due to constant wind pressure shall not exceed 15° ,
- residual freeboard shall not be less than 0.1 m for operating area **3**, and not less than 0.2 m – for operating areas **1** and **2**.

Heeling moment due to crowding of all passengers towards one side shall be calculated in accordance with formula 3.1.3.1.

Heeling moment due to constant wind pressure shall be calculated in accordance with formula 3.1.3.2.

3.4 Ferries

3.4.1 Self-propelled ferries carrying more than 12 passengers shall fulfil the requirements specified in sub-chapter 3.1.

3.4.2 Cable ferries with operating area mark 3 navigating in waters whose flow velocity does not exceed 0.7 m/s are considered as sufficiently stable if L_k/B ratio is less than 4.

For such ferries, the heel shall be calculated for the most adverse, in respect of stability, loading condition. The residual freeboard shall not be less than 0.1 m, and the other bilge shall remain submerged.

3.4.3 Cable ferries with operating area mark 3 navigating in waters whose flow velocity does not exceed 0.7 m/s for which L_k/B ratio is more than 4 and carrying less than 12 passengers shall have the static stability righting lever not less than 200 mm at the heel not less than 15°. Cable ferries carrying more than 12 passengers, shall also fulfil the requirements specified in paragraphs 3.1.2.3 and 3.1.2.4.

3.4.4 Cable ferries with operating area mark 3 navigating in waters whose flow velocity is more than 0.7 m/s, shall fulfil the requirements specified in paragraph 3.4.3 irrespective of L_k/B ratio and depending on the number of carried passengers. Additionally, the angle of heel due to water pressure on the ferry's side (taking into account the suction force acting on the ferry bottom) shall not exceed 6°, or the angle of deck downflooding, or the angle of bilge emergence, whichever is the least.

The angle of heel due to the water pressure and suction force acting on the ferry bottom shall be determined in accordance with the following formula:

$$\varphi = \arcsin\left(\frac{0.15 \cdot L_k \cdot T \cdot l \cdot v_s^2}{D \cdot GM}\right) \quad (3.4.4-1)$$

$$\text{or } \varphi \cong \frac{8.6 \cdot L_k \cdot T \cdot l \cdot v_s^2}{D \cdot GM} \quad (3.4.4-2)$$

where:

L_k – length of ferry, [m],

T – draught in particular loading condition, [m],

D – displacement in particular loading condition, [t],

l – vertical distance between the ferry rope hook and the ferry bottom plane, [m],

v_s – maximum water flow velocity, [m/s].

GM – corrected metacentric height in particular loading condition, [m],

3.4.5 Angle of trim shall be determined for the condition of entering the ferry by the heaviest allowable vehicle. In the most adverse loading condition, the residual freeboard shall not be less than 50 mm.

3.5 Cargo Vessels Carrying other Cargoes than Containers

3.5.1 Cargo Vessels with Length $L_k \leq 110$ m

3.5.1.1 For barges and barge-type vessels with or without their own propulsion which are intended for the carriage of solid cargoes only in cargo holds, stability calculations are not required.

3.5.1.2 For cargo vessels intended for the carriage of large-size deck cargoes, no stability requirements are specified in addition to those contained in Chapter 2, except for vessels with operating area mark 1 for which the maximum static stability lever GZ_{max} shall not be less than 0.2 m for the heel angle not less than 25° in the required load conditions.

3.5.2 Cargo Vessels with Length $L_k > 110$ m

3.5.2.1 Stability requirements for cargo vessels with a length $L_k > 110$ m are subject to PRS agreement in each particular case.

3.6 Vessels Carrying Non-secured Containers

3.6.1 Vessels carrying non-secured containers shall fulfil the following requirements:

- .1** in each loading condition, the corrected metacentric height, GM , shall not be less than 1.0 m;

- .2 vessel's static angle of heel resulting from the centrifugal force due to the vessel's turning, static heel due to wind pressure and due to the effect of free surfaces of liquids shall not exceed 5°, and the deck shall not submerge.

3.6.2 Heeling lever resulting from the centrifugal force due to the vessel's turning, l_c , shall be determined in accordance with the following formula:

$$l_c = 0.04 \cdot \frac{v^2}{L_{WL}} \cdot \left(KG - \frac{T}{2} \right) \text{ [m];} \quad (3.6.2)$$

where:

L_{WL} – length on waterline [m],

v – speed of vessel [m/s],

KG – height of vessel's centre of mass measured from the base plane (corrected for free surface effects) [m],

T – draught in particular loading condition [m].

3.6.3 Heeling lever due to steady wind pressure, l_{sw} , shall be determined in accordance with the following formula:

$$l_{sw} = 0.025 \cdot \frac{F}{D} \cdot \left(Z + \frac{T}{2} \right) \text{ [m];} \quad (3.6.3)$$

where:

F – windage area, including deck cargo [m²],

D – displacement in particular loading condition [t],

Z – distance between the geometric centre of windage area F and waterline [m],

T – draught in particular loading condition [m].

3.6.4 Heeling lever due to the effect of free surfaces of liquids, l_{sp} , such as rain water and residual water in the cargo hold or double bottom shall be determined in accordance with the following formula:

$$l_{sp} = \frac{0.015}{D} \cdot \sum \left(b \cdot l \cdot (b - 0.55 \cdot \sqrt{b}) \right) \text{ [m];} \quad (3.6.4)$$

where:

b – breadth of cargo hold (or its part where longitudinal or transverse bulkheads are applied) [m];

l – length of cargo hold (or its part where longitudinal or transverse bulkheads are applied) [m];

D – displacement of vessel [t].

3.6.5 *Stability Booklet* of vessels carrying non-secured containers shall include the diagram indicating the relation between the permissible location of the vessel's centre of mass KG_{max} and its draught or displacement.

a)
$$KG_{max} = \frac{KM + \frac{B_{WL}}{2F} \cdot \left(Z \cdot \frac{T_m}{2} - l_c - l_{sp} \right)}{\frac{B_{WL}}{2F} \cdot Z + 1} \text{ [m];}$$

No value less than 11.5 ($11.5 = 1/\tan 5^\circ$) shall be taken for $B_{WL}/2F$;

b)
$$KG_{max} = KM - 1.00 \text{ [m];}$$

The lowest value of KG_{max} in accordance with formula (a) or (b) shall be decisive.

Within the formulae:

KG_{max} – maximum permissible height of the laden vessel's centre of gravity above its base line [m];

- KM* – height of the metacenter above the base line [m];
F – respective effective freeboard at $\frac{1}{2} L$ [m];
Z – parameter for the centrifugal force resulting from turning

$$Z = \frac{(0.7 \cdot v)^2}{9.81 \cdot 1.25 L_{WL}} = 0.04 \cdot \frac{v^2}{L_{WL}}$$

- v* – maximum speed of the vessel in relation to the water' [m/s];
T_m – respective average draught, [m];
l_c – heeling lever resulting from lateral wind pressure according to 3.6.3;
l_{sp} – sum of the heeling levers resulting from the free surfaces of liquids according to 3.6.4

3.7 Cargo Vessels Carrying Secured Containers

3.7.1 Vessels carrying secured containers shall fulfil the following limit conditions:

- .1 in each loading condition, corrected metacentric height *GM* shall not be less than 0.50 m;
- .2 static angle of heel resulting from the centrifugal force due to the vessel's turning, from the static heel due to wind pressure and from the effect of free surfaces of liquids shall not exceed the angle of vessel downflooding or angle of static stability range, whichever is lesser.

3.7.2 Righting levers resulting from the centrifugal force due to the vessel's turning, from the static heel due to wind pressure and from the effect of free surfaces of liquids shall be determined in accordance with the requirements specified in sub-chapter 3.6.

3.7.3 *Stability Booklet* of vessels carrying secured containers shall include the diagram indicating the relation between the permissible location of the vessel's centre of mass and its draught or displacement.

3.8 Tugs

3.8.1 Stability of tugs is considered as sufficient if:

- .1 positive range of the static stability levers' curve (angle of downflooding) is 50° or more,
- .2 static stability lever is not less than 0.25 m for vessels with operating area **1** or **2**, or not less than 0.2 m for vessels with operating area mark **3**, at the angle of heel not less than 25°;
- .3 angle of heel resulting from the dynamic moment due to towing cable jerk and wind pressure is less than the critical angle.

Heeling moment resulting from the dynamic pressure of wind and from towing cable jerk, *M_p*, shall be determined in accordance with the following formula:

$$M_p = q \cdot F_w \cdot Z + 1.1 \cdot S_n \cdot (Z_c - T) \text{ [kNm];} \quad (3.8.1.3)$$

where:

- q*, *F_w*, *Z* – see paragraph 2.2.2.2,
S_n – tug's maximum pulling force on pile [kN],
Z_c – towing hook securing height above the base plane [m],
T – draught in particular loading condition [m].

The value of *S_n* shall be determined in accordance with the tug pile pulling tests.

Where the pulling force value is unknown, *S_n* may be assumed according to the engine effective output, *N_e*, [kW]:

- for tugs with moulded displacement *D* < 30 t:
S_n = 0.13 *N_e* – for tugs with un-ducted propeller,
S_n = 0.20 *N_e* – for tugs with ducted propeller,

- for tugs with moulded displacement $D \geq 30$ t,
 $S_n = 0.16 N_e$ – for tugs with un-ducted propeller,
 $S_n = 0.20 N_e$ – for tugs with ducted propeller.

3.9 Ice-breakers

3.9.1 Ice-breakers shall fulfil the requirements specified in paragraphs 3.8.1.1 and 3.8.1.2.

3.9.2 Initial metacentric height, GM , taking account of the liquid free surface allowance, shall not be less than 1.0 m in each loading condition.

3.10 Pushing vessels

3.10.1 Static stability lever at angle of heel 25° shall not be less than 0.20 m and the range of static stability arms curve GZ not less than 50° for pusher tugs operating in area 1.

3.11 Fire-fighting Vessels

3.11.1 Fire-fighting vessels shall fulfil the requirements specified in paragraph 3.8.1, however the moment due to the towing cable jerk shall be replaced by the dynamic heeling moment due to all water monitors in operation directed at the maximum allowable angle to the vessel's centre plane. The dynamic angle of heel shall not exceed the angle of deck downflooding.

3.12 Floating Cranes

3.12.1 In the non-working condition, the crane dynamic angle of heel due to dynamic pressure of wind shall be less than the angle of deck downflooding or the angle of bilge emergence or the angle of crane downflooding if it is lesser than the angle of deck downflooding. Dynamic pressure of wind shall be assumed $q = 0.3$ kPa for cranes with operating area mark 3 and $q = 0.6$ kPa for cranes with operating area mark 1 or 2.

3.12.2 With the maximum load suspended in the longest reach and at heeling moment due to gust of the pressure of $q = 0.2$ kPa, the bilge shall not emerge from water, and the residual freeboard shall not be less than:

- 0.3 m for cranes with operating area mark **1**,
- 0.2 m for cranes with operating area mark **2**,
- 0.1 m for cranes with operating area mark **3**,

and the angle of crane heel shall not exceed:

- 6° for non-slewing cranes,
- 4° for slewing cranes.

3.13 Dredgers

3.13.1 Dredger stability is considered as sufficient if in each loading condition:

- static stability lever is not less than 0.2 m at the angle of heel not less than 25° ,
- angle of heel due to gust wind pressure and other external forces does not exceed 10° ;
- bilge does not emerge from water,
- residual freeboard and residual clearance are not less than:
 - 0.3 m for cranes with operating area mark **1**,
 - 0.2 m for cranes with operating area mark **2**,
 - 0.1 m for cranes with operating area mark **3**.

Confirmation of stability shall be based on the following assumed specific mass of the dredging products:

- sand and gravel – 1.5 t/m³,
- very wet sand – 2.0 t/m³,
- soil – 1.8 t/m³,
- mixture of sand and water in ducts – 1.3 t/m³.

For clamshell dredgers, the above mentioned masses shall be increased by 15%.

Heeling moment due to wind pressure, M_p , shall be calculated in accordance with the following formula:

$$M_p = c \cdot q_w \cdot F_w \cdot \left(Z + \frac{T}{2} \right) \text{ [kNm]}; \quad (3.13.1)$$

where:

c – shape-dependent coefficient of resistance:

for frameworks, $c = 1.2$;

for solid section beams, $c = 1.6$;

$q_w = 0.25$ [kN/m²];

F_w – lateral plane above the plane of maximum draught [m²];

Z – distance from the centre of area of lateral plane, F_w , to the plane of maximum draught [m].

3.14 Pontoons

3.14.1 Pontoons carrying deck cargo shall be considered as cargo vessels.

3.14.2 Pontoons with a portable hoisting device shall be considered as floating cranes.

3.15 Floating Restaurants

3.15.1 Stability of floating restaurants with operating area mark 3 which are permanently attached to a berth shall fulfil the following requirements:

- angle of heel resulting from crowding of all passengers towards one side and from the heeling moment due to constant wind pressure shall not exceed 12°,
- residual freeboard shall not be less than 0.1 m,
- bilge shall not emerge from water.

Calculations shall be performed for the freely floating vessel (irrespective of the action of mooring lines and spring lines).

3.15.2 In operating areas 1 and 2, floating restaurants are not permitted to be permanently attached to a berth on account of the wave height.

3.16 Floating Platforms

3.16.1 Floating platforms shall fulfil the following stability requirements:

- angle of heel resulting from crowding of all passengers towards one side, assuming concentration of 4 persons per square metre, and from steady wind pressure on the platform structure above water line and lateral area of persons standing thereon shall not exceed 6°, the bilge shall not emerge from water and residual freeboard shall not be less than 0.05 m.

Heeling moment resulting from steady wind pressure shall be determined in accordance with formula 3.1.3.2, and the moment resulting from crowding of all passengers towards one side – in accordance with formula 3.1.3.1.

3.17 Pile Drivers

3.17.1 Stability of pile drivers shall be considered the same way as stability of floating cranes (see sub-chapter 3.11).

3.18 Floating Scaffoldings

3.18.1 Floating scaffolding stability in working condition (with persons on the stagings) shall be such that the following conditions are fulfilled:

- the sum of the static heel angle (with the stagings extended) due to the passage of persons to the scaffolding edge on the uppermost staging and the heel angle due to the dynamic action of wind does not exceed 4° ,
- the freeboard on the immersed side is not less than 0.2 m, and
- the bilge on the emerged side does not emerge from water.

3.18.2 Scaffolding structure windage area shall be determined as the area of its side projection increased by factor 1.5 (like for lattice construction). For the purpose of the heeling moment determination, wind pressure shall be taken $q = 0.3$ kPa.

3.18.3 Where L/B ratio for the pontoon is less than 1.5, longitudinal stability of such a pontoon shall also be checked in accordance with 3.18.1 and 3.18.2.

3.18.4 Scaffolding stability in non-working condition (with no persons on stagings) exposed to dynamic wind pressure $q = 0.6$ kPa shall be such that the freeboard on the immersed side is not less than 0.1 m and the bilge on the emerged side does not emerge from water.

3.19 Vessels Carrying Dangerous Goods

3.19.1 Stability of vessels carrying dangerous goods shall comply with the requirements of the *European Agreement Concerning the International Carriage of Dangerous Goods by Inland Waterways* (ADN) contained in *Annex 1*.

4 SUBDIVISION

4.1 General Requirements

4.1.1 To ensure that the vessel for which damage stability criteria are required to be fulfilled will remain buoyant in damaged condition, the hull interior shall be subdivided by transverse and/or longitudinal watertight bulkheads. In passenger vessels with a length $L_k < 15$ m carrying not more than 50 passengers, this may also be ensured by changing permeability of the space by e.g. filling such space or its part with a non-absorbable buoyancy material or by using additional floats permanently fixed to the hull. The buoyancy material used shall be approved by PRS and permanently fixed to the hull.

For other passenger ships application of buoyancy material is subject to PRS consent in each particular case.

4.1.2 Damage stability calculations shall be performed for the required load conditions taking account of three intermediate stages of flooding (25%, 50% and 75% of the final flooding condition) and also for the final flooding condition. Damage stability calculations for the final flooding condition shall be based of method of “lost buoyancy” and the interim states of flooding should be calculated on the basis of the method of “added mass”. All calculations shall be carried out free to trim and sinkage.

4.1.3 Bulkheads and Watertight Doors

4.1.3.1 Vessels shall be provided with a collision bulkhead located in the area between $0.04 L_{WL}$ and $0.04 L_{WL} + 2$ m, measured from the forward perpendicular aftwards.

4.1.3.2 Watertight bulkheads shall extend to the bulkhead deck. Where the bulkhead deck is not arranged, watertight bulkheads shall extend to the level at least 0.2 m above the margin line.

4.1.3.3 Doors in watertight bulkheads are permitted (except for engine room watertight bulkheads) provided that such doors are watertight.

Construction and equipment of bulkheads, watertight doors, sidescuttles and windows shall fulfil the requirements specified in *Part II – Hull* and in *Part III – Hull Equipment*.

4.1.4 Permeability of Compartments

4.1.4.1 In damage stability calculations, permeability shall be taken as follows:

- passenger compartments and crew compartments – 95%,
- engine rooms and boiler rooms – 85%,
- cargo spaces, luggage spaces and store rooms – 75% – for passenger ships,
- cargo spaces containing cargo – 70% for cargo vessels ($L_k > 110$ m),
- double bottom, oil fuel tanks and other tanks – 0% or 95%, depending on whether they are full or empty.

4.1.4.2 Permeability of a compartment may be reduced by filling it with a buoyancy material in accordance with the requirements specified in paragraph 4.1.1.

4.2 Specific Requirements for Particular Types of Vessels

4.2.1 Passenger Vessels

4.2.1.1 Passenger vessels with a length $L_k < 25$ m carrying not more than 50 passengers shall prove adequate stability after damage in accordance with 4.2.1.2 and 4.2.1.4 or, as an alternative shall be so subdivided with bulkheads that after symmetrical flooding of a compartment, the following requirements be fulfilled:

- the vessel’s draught shall not be above the margin line,
- metacentric height GM shall not be less than 0.10 m,
- in the intermediate stage of flooding metacentric height GM shall have a positive value.

4.2.1.2 Passenger vessels with a length $L_k < 45$ m carrying not more than 250 passengers shall be so subdivided with bulkheads that after one compartment has been flooded, the requirements specified in paragraph 4.2.1.4 be fulfilled for the following extent of damage:

Table 4.2.1.2

Side damage	Extent of damage for one-compartment status
longitudinal, [m]	0.10 L_{WL} , however not less than 4.0 m
transverse, [m]	$B/5$
vertical, [m]	from vessel bottom to top without delimitation
Bottom damage	
longitudinal, [m]	0.10 L_{WL} , however not less than 4.0 m
transverse, [m]	$B/5$
vertical, [m]	0.59; where a pipework system has no open outlet in a compartment; the pipework shall be regarded as intact in the event of this compartment being damaged, if it runs within the safe area and is more than 0.50 m from vessels bottom

Where damage of the size smaller than specified above brings more severe effects such as heel or the metacentric height loss, this shall also be taken into account in the calculations.

4.2.1.3 In the case of one compartment being damaged, bulkheads are considered as intact, if the distance between two adjacent bulkheads is greater than the length of damage. Longitudinal bulkheads spaced less than $B/3$ measured perpendicularly to the centre plane from the plating at the level of maximum submersion shall not be taken into account. A recess in transverse bulkhead more than 2.50 m in length is considered as longitudinal bulkhead.

4.2.1.4 Passenger vessels with a length $L_k \geq 45$ m or passenger vessels carrying more than 250 passengers shall be so subdivided with bulkheads that after one compartment and two adjacent compartments have been flooded, the requirements specified in paragraph 4.2.1.5 be fulfilled for the following extent of damage:

Table 4.2.1.4

Side damage	Extent of damage for one-compartment status	Extent of damage for two-compartment status
longitudinal, [m]	0.10 L_{WL} , however not less than 4.0 m	0.05 L_{WL} , however not less than 2.25 m
transverse, [m]	$B/5$	0.59
vertical, [m]	from vessel bottom to top without delimitation	
Bottom damage		
longitudinal, [m]	0.10 L_{WL} , however not less than 4.0 m	0.05 L_{WL} , however not less than 2.25 m
transverse, [m]	$B/5$	
vertical, [m]	0.59; where a pipework system has no open outlet in a compartment; the pipework shall be regarded as intact in the event of this compartment being damaged, if it runs within the safe area and is more than 0.50 m from vessel's bottom	

Where damage of the size smaller than specified above causes more severe effects such as heel or the metacentric height loss, this shall also be taken into account in the calculations.

4.2.1.5 In the event of two compartments being damaged, each bulkhead within such damage is considered as damaged. This means that, bulkheads shall be so arranged as to ensure the vessel remaining afloat after two or more adjacent compartments along the centre plane have been flooded.

4.2.1.6 Damage Stability Criteria

4.2.1.6.1 For all intermediate stages of flooding, the following criteria shall be fulfilled:

- .1 heeling angle at the equilibrium position of the intermediate stage in question shall not exceed 15° ,
- .2 beyond the heel in the equilibrium position of the intermediate stage in question, the positive part of the righting lever curve shall display a righting level value of $GZ \geq 0.02$ m before the first unprotected opening becomes immersed or the heeling angle of 25° is reached (whichever is lesser),
- .3 non-watertight openings shall not be immersed before the heel in the equilibrium position of the intermediate stage in question has been reached,
- .4 the calculation of the free surface effect in all intermediate stages of flooding shall be based on the gross surface area of the damaged compartments.

4.2.1.6.2 During the final stage of flooding, the following criteria shall be fulfilled taking into account the heeling moment due to crowding of all passengers towards one side:

- .1 heeling angle φ_p shall not exceed 10° ;
- .2 beyond the equilibrium position, the positive part of the righting lever curve shall display a righting lever value of $GZ \geq 0.02$ m with an area $A \geq 0.0025$ mrad. These minimum values for stability shall be reached until the immersion of the first unprotected opening or before reaching a heeling angle not exceeding 25° (whichever is lesser) see Fig. 4.2.1.4.2.2;

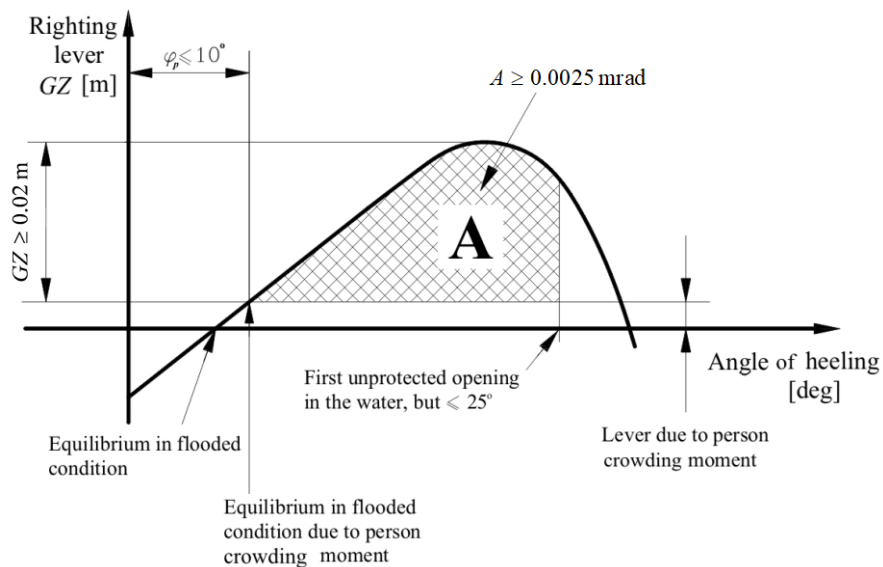

Fig. 4.2.1.6.2.2

- .3 non-watertight openings shall not be immersed before the equilibrium position has been reached; if such openings are immersed before this point, the rooms affording access are deemed to be flooded for damaged stability calculations;
- .4 where shut-off devices are applied, these shall be watertight and capable of being closed and also marked respectively;
- .5 if cross-flood openings to reduce asymmetrical flooding are provided, they shall fulfil the following conditions:
 - for cross-flooding calculation, IMO *Resolution A.266 (VIII)* shall be applied;
 - they shall not be equipped with shut-off devices and they shall be self-acting;
 - total time allowed for compensation shall not exceed 15 minutes.

4.2.1.6.3 At the final stage of flooding, the lowermost point of an opening which does not ensure watertightness (e.g. doors, windows, hatches) shall be situated at least 0.1 m above the damage waterline and the bulkhead deck shall not be flooded.

4.2.2 Cargo Vessels with Length $L_k > 110$ m

4.2.2.1 Cargo vessels with length $L_k > 110$ m shall be so subdivided with bulkheads that the vessel loaded evenly to the maximum draught fulfils the requirements specified in 4.2.2.2 and 4.2.2.3 after at least two adjacent compartments (except for the machinery space for which only one-compartment damage shall be taken into account, i.e. it shall be considered that the bulkheads bounding the machinery space are intact) have been flooded for the following extent of damage:

- .1 side damage:
 - longitudinal: at least $0.10 L_k$,
 - transverse: 0.59 m,
 - vertical: from base plane to top without delimitation,
- .2 bottom damage:
 - longitudinal: at least $0.10 L_k$,
 - transverse: 3.0 m,
 - vertical: from the base at the level of 0.39 m to top (except for the bilge).

It shall be assumed that bulkheads in the damaged compartment are also damaged.

For the bottom damage, it shall be assumed that the compartments adjacent to the damaged one will also be flooded.

The calculation of the final state of flooding should be based on the method of “lost buoyancy” and the intermediate states of flooding should be calculated on the basis of the method of “added mass”.

All calculations shall be carried out free to trim and sinkage.

Stability shall be determined for the intermediate stages of flooding (25%, 50% and 75% of final stage of flooding, and, where appropriate, for the stage immediately prior to transverse equilibrium) and for the final stage of flooding, in the loading conditions.

4.2.2.2 During intermediate stages of flooding the following requirements shall be fulfilled:

- at any intermediate stage of flooding, the angle of heeling shall not exceed 15° or 5° , for the carriage of unsecured containers;
- for the angle of heeling beyond the equilibrium position at any stage of flooding, the curve of righting levers GZ shall, in its positive part, take values of righting lever $GZ \geq 0.02$ m or 0.03 m, for the carriage of unsecured containers, before the first unprotected opening has been flooded or before the angle of heeling has reached the value of 27° or 15° , for the carriage of unsecured containers;
- non-watertight openings shall not be flooded before the angle of heel reaches the equilibrium position at any intermediate stage.

4.2.2.3 During the final stage of flooding, the following requirements shall be fulfilled:

- the lowermost point of not watertight openings (e.g. doors, windows, hatches) being closed shall be situated at least 0.1 m above the damage waterline;
- heeling angle for the equilibrium position shall not exceed 12° or 5° , for the carriage of unsecured containers;
- for the angle of heeling beyond the equilibrium position at the final stage of flooding, the curve of righting levers GZ shall, in its positive part, take values of righting lever $GZ \geq 0.05$ m, and the area under GZ curve shall reach the value of 0.0065 mrad before the first unsecured compartment has been flooded or the angle of heeling has reached the value of 27° or 10° , for the carriage of unsecured containers (see Fig. 4.2.2.3);

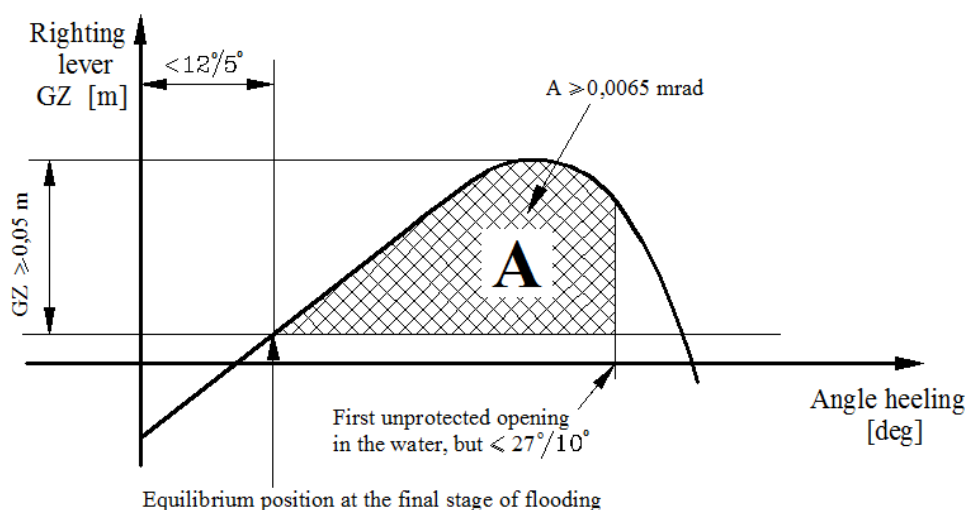

Fig. 4.2.2.3

- if non-watertight openings are immersed before the equilibrium position has been reached, the rooms affording access are deemed to be flooded for damaged stability calculations.

4.2.2.4 Where cross-flood openings are provided to reduce asymmetrical flooding, the following conditions shall be fulfilled:

- for the calculation of cross-flooding, IMO Resolution A.266 (VIII) shall be applied;
- they shall not be equipped with shut-off devices and they shall be self-acting;
- total time allowed for compensation shall not exceed 15 minutes.

4.2.2.5 If the openings which are likely to enable the flooding of intact rooms are capable of being tightly closed, the closing appliances shall be provided on both sides with notice “Close immediately after passing”.

4.2.2.6 If a cargo vessel of length $L_k > 110$ m fulfils the requirements specified in sub-chapter 4.2.4 – it also meet calculations in accordance with 4.2.2.1 to 4.2.2.5.

4.2.3 Floating Restaurants

4.2.3.1 Floating restaurants shall fulfil the damage stability requirements depending on both their length L_k and the number of persons present on board (in accordance with the requirements specified in sub-chapter 4.2.1).

4.2.3.2 For floating restaurants moored on shallow waters (up to the maximum depth of 1.5 m taking account of the water level variation) damage stability calculations are not required.

4.2.4 Vessels Carrying Dangerous Goods

4.2.4.1 Damage stability of vessels carrying dangerous cargoes shall be in accordance with the requirements of the *European Agreement Concerning the International Carriage of Dangerous Goods by Inland Waterways (ADN)* contained in *Annex 1*.

5 FREEBOARD

5.1 Application

5.1.1 The requirements specified in Chapter 5 apply to all inland waterways vessels, both with and without their own propulsion, carrying cargoes and passengers on inland waterways.

5.1.2 For the purpose of determining freeboard, vessels are divided into the following types:

- Type A – fully decked vessels whose cargo hatches are so closed as to protect cargo holds against water penetration into the vessel;
- Type B – tankers, provided with only small manholes with watertight means of closing which provide access to cargo holds;
- Type C – vessels not having a continuous deck and vessels whose cargo hatches are not provided with means of closing which preclude water penetration into the vessel.

5.2 General Provisions

5.2.1 Freeboard is determined depending on the operating areas specified in *Part I – Classification Regulations*.

5.2.2 Freeboard determined for the particular operating area is constant, irrespective of the season or transfer from fresh waters to sea waters.

5.2.3 The condition for determining freeboard is fulfilment of the requirements specified in sub-chapter 5.6.

5.2.4 The principles for determining freeboard specified in Chapter 5 are based on the assumption that the vessel's service conditions will be in accordance with good seamanship in respect of proper stowage of cargo, stores, passengers, etc.

5.3 Scope of Survey

5.3.1 For each vessel which is subject to the freeboard requirements, PRS survey covers:

- .1** prior to commencement of the vessel's construction:
 - verification of the freeboard preliminary calculations and assessment of the proposed freeboard marking accuracy;
- .2** on completion of the vessel's construction;
 - verification of the freeboard final calculations and assessment of the freeboard marking accuracy as well as verification that the freeboard designation conditions have been fulfilled (see sub-chapter 5.6);
- .3** within periodical surveys;
 - verification that the freeboard determining conditions are maintained and visual examination of the load line mark.

5.4 Freeboard Assignment

5.4.1 Required freeboard, F , for vessels having a continuous deck without sheer and superstructures shall be determined as follows:

- .1** for vessels of type A, basic freeboard F shall be determined in accordance with Table 5.4.1.1. For intermediate values of the length of vessel, the basic freeboard shall be determined by linear interpolation;

Table 5.4.1.1

Length of vessel L_k [m]	Basic freeboard F , [mm]	
	Operating area 1	Operating area 2
≤ 30	250	250
40	340	300
50	440	300
$60 = L_k \leq 110$	570	300

- .2** for vessels of type B, basic freeboard F shall be determined in accordance with Table 5.4.1.2. For intermediate values of the length of vessel, the basic freeboard shall be determined by linear interpolation;

Table 5.4.1.2

Length of vessel L_k [m]	Basic freeboard F , [mm]	
	Operating area 1	Operating area 2
≤ 30	180	160
40	250	220
50	330	220
$60 = L_k \leq 110$	420	220

- .3 for vessels of type C, basic freeboard F does not depend on the length of vessel and shall not be less than:
 1000 mm – for operating area 1
 600 mm – for operating area 2
- .4 for vessels of type A, B and C without sheer and superstructures, basic freeboard F shall not be less than 150 mm for operating area 3.

5.4.2 For vessels with superstructures and sheer, corrected freeboard F_p shall be determined in accordance with the following formula:

$$F_p = F \cdot (1 - a) - \frac{b_{dz} \cdot Se_{dz} + b_r \cdot Se_r}{15} \text{ [mm];} \quad (5.4.2-1)$$

where:

- F – basic freeboard;
- a – correction for superstructures;
- b_{dz} – correction for the effect of forward sheer resulting from the presence of superstructures in the forward quarter of the length of vessel;
- b_r – correction for the effect of aft sheer resulting from the presence of superstructures in the aft quarter of the length of vessel, L_k ;
- Se_{dz} – effective forward sheer [mm];
- Se_r – effective aft sheer [mm];

Correction a shall be determined in accordance with the following formula:

$$a = \frac{\sum le_r + \sum le_s + \sum le_{dz}}{L_k} \quad (5.4.2-2)$$

where:

- le_s – effective length of a superstructure located in the median part corresponding to the half of the length of vessel, L_k [m];
- le_{dz} – effective length of a superstructure in the forward quarter of vessel length, L_k [m];
- le_r – effective length of a superstructure in the aft quarter of vessel length, L_k [m].

Effective length of superstructures shall be determined in accordance with the following formula:

$$le_s = l \cdot \left(2.5 \frac{b}{B} - 1.5\right) \cdot \frac{h}{0.6 \cdot h_f} \text{ [m];} \quad (5.4.2-3)$$

$$le_{dz}, le_r = l \cdot \left(2.5 \frac{b}{B_1} - 1.5\right) \cdot \frac{h}{0.6 \cdot h_f} \text{ [m];} \quad (5.4.2-4)$$

where:

- l – effective length of the particular superstructure [m];
- b – effective breadth of the particular superstructure [m];
- B_1 – breadth of vessel measured on the outside of vertical sideplates at the deck level halfway along the particular superstructure [m];
- h – height of particular superstructure [m]. However, in the case of hatches, the value of h is obtained by reducing the hatch coaming height by half of the safety distance in accordance with the requirements specified in paragraph 5.4.4. In no case shall a value exceeding $0.6 h_f$ be taken for h ;
- h_f – maximum wave height for the given operating area:
 $h_f = 2.0$ m – for operating area 1,
 $h_f = 1.2$ m – for operating area 2,
 $h_f = 0.6$ m – for operating area 3.

If $\frac{b}{B}$, or $\frac{b}{B_1}$ is lesser than 0.6, the effective length le_i of the superstructure will be zero; where:
 $i = dz, r, \text{ or } s$.

Coefficients b_{dz} and b_r shall be determined in accordance with the following formulae:

$$b_{dz} = 1 - \frac{3 \cdot l_{e_{dz}}}{L_k} \quad (5.4.2-5)$$

$$b_r = 1 - \frac{3 \cdot l_{e_r}}{L_k} \quad (5.4.2-6)$$

Effective aft/forward sheers Se_{dz} and Se_r shall be calculated in accordance with the following formulae:

$$Se_{dz} = S_{dz} \cdot p \quad (5.4.2-7)$$

$$Se_r = S_r \cdot p \quad (5.4.2-8)$$

where:

S_{dz} – actual forward sheer [mm], S_{dz} , however, shall not exceed 1000 mm;

S_r – actual aft sheer [mm], S_r , however, shall not exceed 500 mm;

Coefficient p shall be taken in accordance with Table 5.4.2.

Table 5.4.2

X / L_k	≥ 0.25	0.20	0.15	0.10	0.05	0
p	1.0	0.8	0.6	0.4	0.2	0

X – abscissa, measured from the extremity of the point where the sheer is $0.25 \cdot S_{dz}$ or $0.25 \cdot S_r$ from the forward perpendicular or after perpendicular, respectively.

If the value of $b_r \cdot Se_r$ is greater than $b_{dz} \cdot Se_{dz}$, then the value $b_r \cdot Se_r$ shall be taken as $b_{dz} \cdot Se_{dz}$.

5.4.3 Minimum freeboard F_p , after considering all corrections shall not be less than:

- for vessels of type A:
 - 250 mm – for operating area 1,
 - 180 mm – for operating area 2,
 - 50 mm – for operating area 3.
- for vessels of type B:
 - 180 mm – for operating area 1,
 - 160 mm – for operating area 2,
 - 50 mm – for operating area 3.
- for vessels of type C:
 - 300 mm – for operating area 1,
 - 200 mm – for operating area 2,
 - 100 mm – for operating area 3.

and

300 mm – for floating equipment - operating area 3.

The freeboard may be reduced if it is proven that the requirements of 5.4.3.1 have been met, for all operating conditions;

- after correction for the free surfaces of liquids, the metacentric height is not less than 0.15 m;
- for heeling angles between 0° and 30° , there is a righting lever of at least:

$$h = 0.30 - 0.28 \phi_v \text{ [m];}$$

ϕ_v – being the heeling angle from which the righting lever curve displays negative values (range of stability): it shall not be less than 20° or 0.35 rad and shall not be introduced into the formula for more than 30° or 0.52 rad, taking the radian (rad) ($1^\circ = 0.01745 \text{ rad}$) for the unit of ϕ_v ;

- the sum of trim and heeling angles does not exceed 10° ;

- a residual safety clearance meeting the requirements in 5.4.4 remains;
- residual freeboard of at least 0.05 m remains;
- for heeling angles between 0° and 30°, there is a righting lever of at least:

$$h = 0.20 - 0.23 \phi_v, \text{ [m];}$$

remains, where ϕ_v is the heeling angle from which the righting lever curve displays negative values; it shall not be introduced into the formula for more than 30° or 0.52 rad.

Residual righting lever means the maximum difference existing between 0° and 30° of heel between the righting lever curve and the heeling lever curve. If an opening towards the inside of the vessel is reached by the water at a heeling angle less than that corresponding to the maximum difference between the lever curves, the lever corresponding to that heeling angle shall be taken into account.

5.4.4 Minimum safety clearance of openings shall not be less than:

- for vessels of types A and B:
 - 900 mm – for operating area **1**,
 - 600 mm – for operating area **2**,
 - 300 mm – for operating area **3**;
- for vessels of type C:
 - 1200 mm – for operating area **1**,
 - 1000 mm – for operating area **2**,
 - 500 mm – for operating area **3**.

5.4.5 Cargo vessels operating in area 1 shall have weathertight closings of hatches. Where the safe height measured to the upper edge of hatch coaming exceeds 1200 mm, the hatch closing appliances may be splashtight.

5.4.6 In case any weather restrictions have been imposed, PRS may – at the request of the Owner or design engineer – grant an exemption from the requirement of the minimum freeboard and the safety clearance of openings on condition that safe passage has been provided for the crew throughout the length of vessel (see also subchapter 1.4.7).

5.4.7 The safety clearance of doors and openings other than hold hatches for vessels navigation on Zone 4 waterways is reduced as follows:

- for openings which can be closed spray-proof and weathertight to 150 mm,
- for openings which cannot be closed spray-proof and weathertight to 200 mm.

5.5 Freeboard Marking

5.5.1 Freeboard marking consists of the deck line mark and load line mark. Exemplary freeboard marking is shown in Fig. 5.5.3.

5.5.2 Freeboard marking shall be placed on each side of the vessel at half of the length of vessel, L_k .

5.5.3 Deck line mark shall have the dimensions 300×25 mm and shall be so situated that its upper edge shall normally pass through the point where the continuation outwards of the upper surface of the freeboard deck intersects the outer surface of the shell. Deck line mark may be placed with reference to another fixed point on the vessel, on condition that the freeboard is corrected accordingly.

View on SB

On PS similarly, with the same order of letters P R
Additional load lines are always marked towards bow

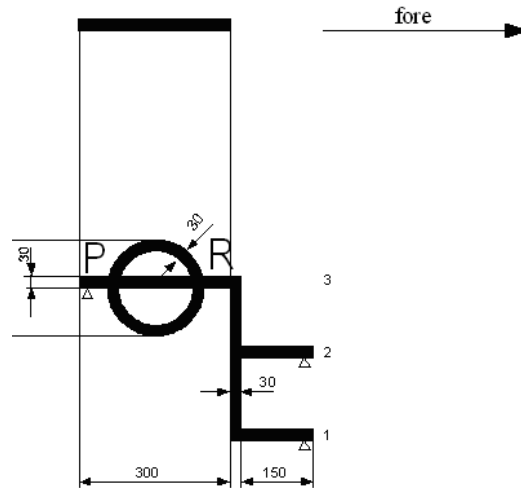

Fig. 5.5.3

5.5.4 Load line mark consists of a ring having 200 mm in outside diameter and 30 mm in breadth, a central horizontal line with the dimensions 300×30 mm whose lower edge passes through the ring centre as well as additional horizontal load lines with the dimensions 150×30 mm, if applicable (Fig. 5.5.3).

5.5.5 Distance between the upper edge of the deck line and the lower edge of horizontal line passing through the centre of load line mark ring determines the freeboard.

5.5.6 Additional horizontal load lines orientated fore from the vertical line of the load line mark determine freeboard values for additional operating areas of the inland waterway vessel (Fig. 5.5.6). The value of such an additional freeboard is determined by the distance from the upper edge of the deck line mark to the lower edge of the corresponding load line.

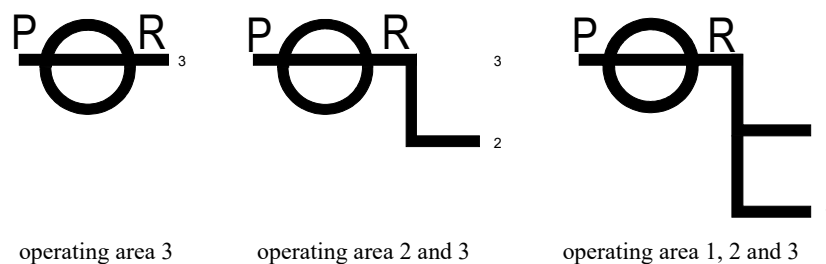

Fig. 5.5.6

5.5.7 Operating areas 1, 2 and 3 shall be marked with Arabic numeral of the dimensions 60×40 mm. Numerals indicating operating areas shall be placed with their base at the level of the lower edge of such an additional line just after its end.

5.5.8 It is permitted to place an additional line restricting the draught of the vessel carrying cargo in its holds. The line corresponding to an approved draught of the vessel for ore cargo shall be marked in accordance with Fig. 5.5.8.

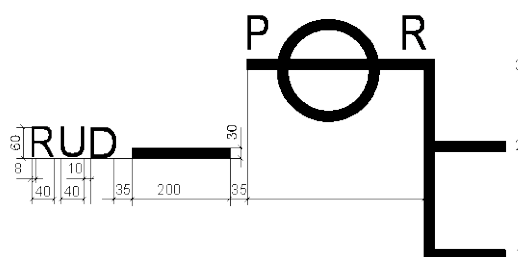

Fig. 5.5.8

5.5.9 Load line mark shall include letters "P" and "R" placed on each side of the ring over its centre line which indicates that the freeboard has been assigned by Polski Rejestr Statków. The dimensions of the letters shall be: 75×50 mm.

5.5.10 Where the freeboard is lesser than 150 mm, the deck line mark shall not be placed on the side. Where the freeboard is lesser than 120 mm, the upper part of the load line ring shall not also be placed, whereas letters "P" and "R" shall be placed below the centre line, as shown in Fig. 5.5.10.

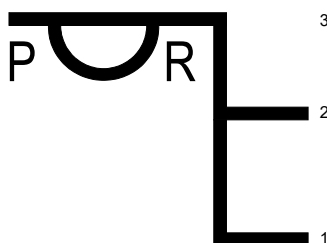

Fig. 5.5.10

5.5.11 The load line mark including its letters and numerals shall be permanently placed on each side of the vessel. These marks shall be painted with a colour contrasting with the colour of the vessel's sides.

5.6 Freeboard Assignment Conditions

5.6.1 Construction of the hull and deck erections (superstructures, deckhouses, companionways, machinery casings, etc.), hatch coamings and hatch closing arrangements, ventilation heads, air pipes, skylights, sidescuttles, drain pipes together with their fittings as well as closing arrangements of sidescuttles shall fulfil the requirements specified in *Part II – Hull*, *Part III – Hull Equipment* and *Part VI – Machinery and Piping Systems*.

5.6.2 Openings in the sides of the vessel shall be fitted with watertight means of closing.

5.6.3 Openings in the freeboard deck or in the walls of confined spaces of deck erections shall fulfil the conditions specified in Table 5.6.3.

Table 5.6.3

Type of vessel	Type of opening	Tightness of means of closing	
		Operating area 1	Operating areas 2 and 3
A	cargo hatches other hatches doorways	weathertight weathertight splash-proof	splash-proof splash-proof splash-proof
B	cargo hatches other hatches doorways	watertight weathertight splash-proof	watertight splash-proof splash-proof
C	cargo hatches other hatches doorways	– weathertight splash-proof	– splash-proof splash-proof

5.6.4 Closing arrangements of cargo hatches in type A vessels with operating area mark 1 may be weathertight, provided the total of the freeboard and height of hatch coamings is not less than 1200 mm. This also applies to closing arrangements of hatches other than cargo hatches in type C vessels.

5.6.5 Coaming height of openings in the freeboard deck and doorsteps in enclosed deck erections shall be in accordance with Table 5.6.5.

Table 5.6.5

Type of openings	Type of vessel	Height of coaming/doorstep, [mm]	
		Operating area 1	Operating areas 2 and 3
cargo hatches and other hatches	A, B, C	300	250
doorways	A, B, C	300	150

5.6.6 Where the height of coamings and doorsteps is lesser than that specified in Table 5.6.5, the uncorrected freeboard shall be increased by the difference between the actual and required values.

5.6.7 Ventilation heads and openings as well as air pipes shall have coamings of the height in accordance with the requirements specified in *Part VI – Machinery and Piping Systems*. Ventilation heads and air pipes shall be provided with effective means for their closing during heavy weather conditions.

5.6.8 Scuttles, skylights and windows in superstructures shall be provided with at least splash-proof means of closing, whereas sidescuttles shall be provided with watertight means of closing and permanently mounted deadlights. In passenger vessels, sidescuttles shall be of the non-opening type.

5.6.9 The number of openings in the shell plating shall be kept to a minimum as necessary and the pipes led overboard shall be provided with effective and available means protecting against water penetration into the vessel.

ANNEX 1

**REQUIREMENTS FOR STABILITY AND SUBDIVISION
OF VESSELS CARRYING DANGEROUS GOODS (acc. to ADN)****I Vessels Carrying Dry Dangerous Goods****I.1 Stability (general)**

- (1) Proof of sufficient stability, including stability in the damaged condition, shall be furnished.
- (2) Basic values for the stability calculation – the vessel's lightweight and the location of the centre of gravity – shall be determined either by means of an inclining experiment or by detailed mass and moment calculation. In the latter case the lightweight shall be checked by means of a lightweight test with a resulting difference of not more than $\pm 5\%$ between the mass determined by the calculation and the displacement determined by the draught readings.
- (3) Proof of sufficient intact stability shall be furnished for all stages of loading and unloading and for the final loading condition.
- (4) Floatability after damage shall be proved for the most unfavourable loading condition. For this purpose calculated proof of sufficient stability shall be established for critical intermediate stages of flooding and for the final stage of flooding. Negative values of stability in intermediate stages of flooding may be accepted only if the continued range of curve of righting lever in damaged condition indicates adequate positive values of stability.

I.2 Intact Stability

- (1) The requirements for intact stability resulting from the damaged stability calculation shall be fully complied with.
- (2) For the carriage of containers, proof of sufficient stability shall also be furnished in accordance with the provisions of the local, regional or international rules concerning carriage of cargoes on inland waterways.
- (3) The most stringent of the requirements specified in (1) and (2) above shall prevail for the vessel.

I.3 Damage Stability

- (1) The following assumptions shall be taken into consideration for the damage stability determination:
 - a) the extent of side damage is as follows:
 - longitudinal extent: at least $0.10L_k$, however not less than 5.0 m;
 - transverse extent: 0.59 m;
 - vertical extent: from the base plane upwards without limit;
 - b) the extent of bottom damage is as follows:
 - longitudinal extent: at least $0.10L_k$, however not less than 5.0 m;
 - transverse extent: 3.00 m;
 - vertical extent: from the base plane 0.59 m upwards, the sump excepted;
 - c) any bulkheads within the damaged area shall be assumed damaged, which means that the location of bulkheads shall be so chosen as to ensure that the vessel remains buoyant after the flooding of two or more adjacent compartments in the longitudinal direction.

The following provisions are applicable:

- for bottom damage, adjacent athwartship compartments shall also be assumed as flooded;
- the lower edge of any non-watertight openings (e.g. doors, windows, access hatchways) shall, at the final stage of flooding, be not less than 0.10 m above the damage waterline;

- in general, permeability shall be assumed to be 95%. Where an average permeability of less than 95% is calculated for any compartment, this calculated value obtained may be used.

However, the following minimum values shall be used:

- engine rooms: 85%
- accommodation spaces: 95%
- double bottoms, oil fuel tanks, ballast tanks: 0% or 95% depending on whether, according to their function, they have to be assumed as full or empty for the vessel floating at the maximum permissible draught.

For the main engine room only the one-compartment standard need be taken into account, i.e. the end bulkheads of the engine room shall be assumed as not damaged.

- (2) At the equilibrium position (final stage of flooding), the angle of heel shall not exceed 12° . Non-watertight openings shall not be flooded before reaching the equilibrium position. If such openings are immersed before that stage, the corresponding spaces shall be considered as flooded for the purpose of the stability calculation.

Positive range of the righting lever curve beyond the equilibrium position shall have a righting lever GZ of ≥ 0.05 m in association with an area under the curve A of ≥ 0.0065 mrad. The minimum values of stability shall be satisfied up to immersion of the first non-watertight opening and in any event up to an angle of heel $\leq 27^\circ$. If non-watertight openings are immersed before that stage, the corresponding spaces shall be considered as flooded for the purpose of stability calculation.

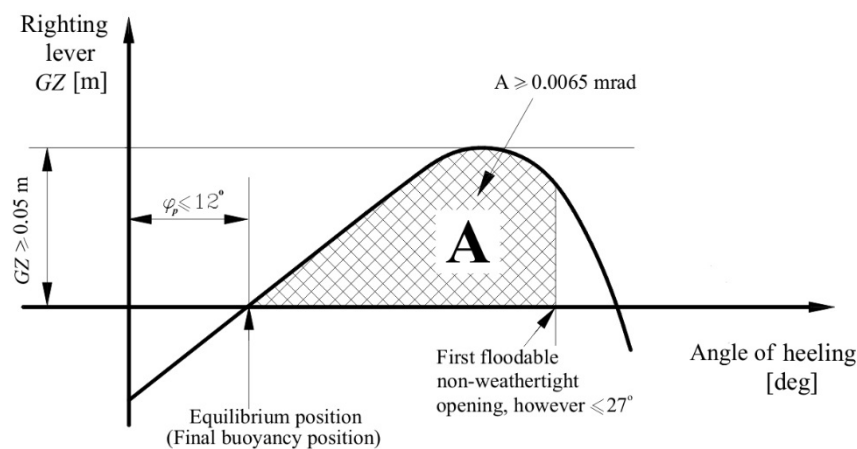

Fig. 1

(2a) *Damage stability of vessels carrying dangerous goods in unsecured containers*

At the equilibrium position (final stage of flooding) the angle of heel shall not exceed 5° . Non-watertight openings shall not be immersed before reaching the equilibrium position. If such openings are immersed before that stage, the corresponding spaces shall be considered as flooded for the purpose of stability calculation.

The positive range of the righting lever curve beyond the equilibrium position shall have an area under the curve of ≥ 0.0065 mrad. The minimum values of stability shall be satisfied up to immersion of the first non-weather-tight opening and in any event up to an angle of heel $\leq 10^\circ$. If non-weather-tight openings are immersed before that stage, the corresponding spaces shall be considered as flooded for the purpose of stability calculation.

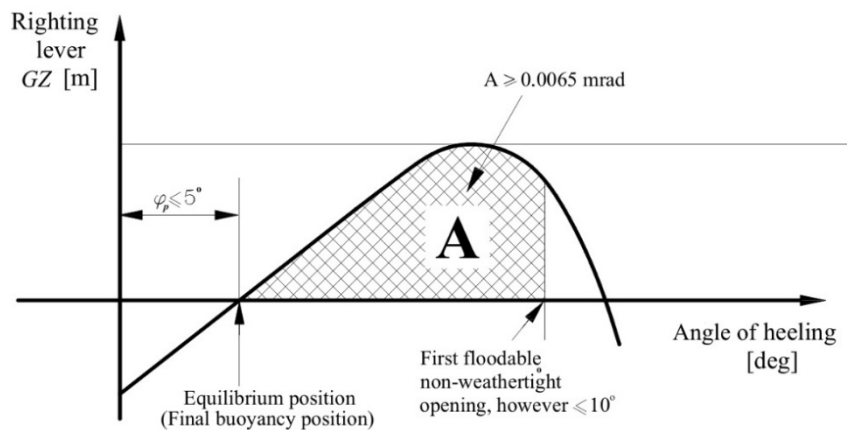

Fig. 2

- (3) If openings through which undamaged compartments may become additionally flooded are capable of being closed watertight, the closing devices shall be marked appropriately.
- (4) Where cross- or down-flooding openings are provided for reduction of unsymmetrical flooding, the time for equalisation shall not exceed 15 minutes if during the intermediate stages of flooding sufficient stability has been proved.

II Tankers Carrying Dangerous Liquid Cargoes

II.1 Tanker Types

The following types of tankers are distinguished:

Type G: means a tank vessel intended for the carriage of gas. Carriage may be under pressure or liquefied under refrigeration;

Type C: means a tank vessel intended for the carriage of liquids. The vessel shall be of the flush-deck/double-hull spaces, double bottoms, however without trunk. The cargo tanks may be formed by the vessel's inner hull or may be installed in the hold spaces as independent tanks;

Type N: means a tank vessel intended for the carriage of liquids.

The examples of these types of tankers are shown in Fig. 3.

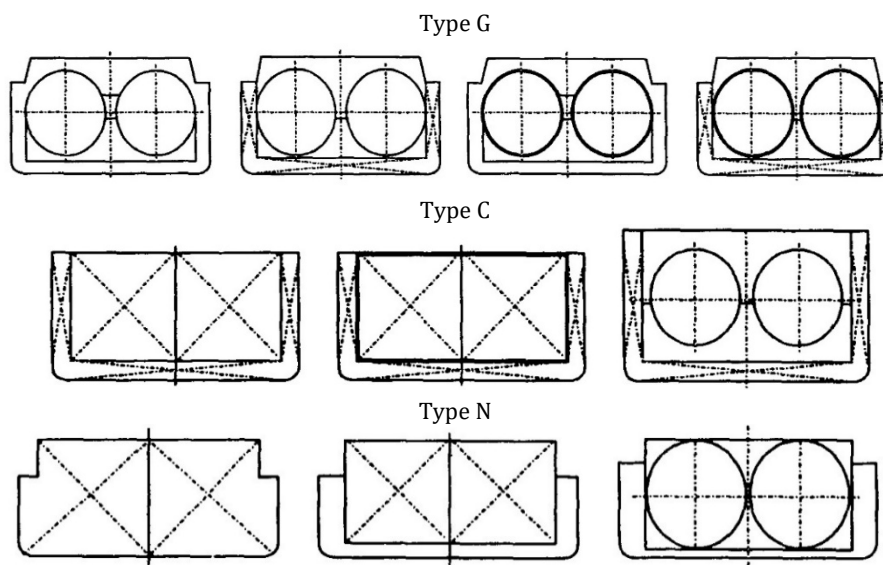

Fig. 3

Dangerous liquid cargoes which may be carried by tankers of the particular types are specified in Chapter 3.2 of Part III of *ADN Rules*.

II.2 Requirements for Type G Tankers

II.2.1 Stability (general)

- (1) Proof of sufficient stability, including stability in damaged condition, shall be furnished.
- (2) Basic values for the stability calculation – the vessel's lightweight and the location of the centre of gravity – shall be determined either by means of an inclining experiment or by detailed mass and moment calculation. In the latter case the lightweight shall be checked by means of a lightweight test with a resulting difference of not more than $\pm 5\%$ between the mass determined by the calculation and the displacement determined by the draught readings.
- (3) Proof of sufficient intact stability shall be furnished for all stages of loading and unloading and for the final loading condition. Floatability after damage shall be proved for the most unfavourable loading condition. For this purpose calculated proof of sufficient stability shall be established for critical intermediate stages of flooding and for the final stage of flooding. Negative values of stability in intermediate stages of flooding may be accepted only if the continued range of curve of righting lever in damaged condition indicates adequate positive values of stability.

II.2.2 Intact Stability

The requirements for intact stability resulting from the damaged stability calculation shall be fully complied with.

II.2.3 Damage Stability

- (1) The following assumptions shall be taken into consideration for the damage stability determination:
 - (a) the extent of side damage is as follows:
 - longitudinal extent: at least $0.10L_k$, however not less than 5.00 m;
 - transverse extent: 0.79 m;
 - vertical extent: from the base plane upwards without limit;
 - (b) the extent of bottom damage is as follows:
 - longitudinal extent: at least $0.10L_k$, however not less than 5.00 m;
 - transverse extent: 3.00 m;
 - vertical extent: from the base plane 0.59 m upwards, the sump excepted;
 - (c) any bulkheads within the damaged area shall be assumed damaged, which means that the location of bulkheads shall be so chosen as to ensure that the vessel remains buoyant after the flooding of two or more adjacent compartments in the longitudinal direction.

The following provisions apply:

- for bottom damage, adjacent athwartship compartments shall also be assumed as flooded;
- the lower edge of any non-watertight openings (e.g. doors, windows, access hatchways) shall, at the final stage of flooding, be not less than 0.10 m above the damage waterline;
- in general, permeability shall be assumed to be 95%. Where an average permeability of less than 95% is calculated for any compartment, this calculated value obtained may be used.

However, the following minimum values shall be used:

- engine rooms: 85%

- accommodation spaces: 95%
- double bottoms, oil fuel tanks, ballast tanks: 0% or 95% depending on whether, according to their function, they have to be assumed as full or empty for the vessel floating at the maximum permissible draught.

For the main engine room only the one-compartment standard need be taken into account, i.e. the end bulkheads of the engine room shall be assumed as not damaged.

- (2) At the equilibrium position (final stage of flooding), the angle of heel shall not exceed 12° . Non-watertight openings shall not be flooded before reaching the equilibrium position. If such openings are immersed before that stage, the corresponding spaces shall be considered as flooded for the purpose of the stability calculation.

Positive range of the righting lever curve beyond the equilibrium position shall have a righting lever GZ of ≥ 0.05 m in association with an area under the curve A of ≥ 0.0065 mrad. The minimum values of stability shall be satisfied up to immersion of the first non-watertight opening and in any event up to an angle of heel $\leq 27^\circ$. If non-watertight openings are immersed before that stage, the corresponding spaces shall be considered as flooded for the purpose of stability calculation.

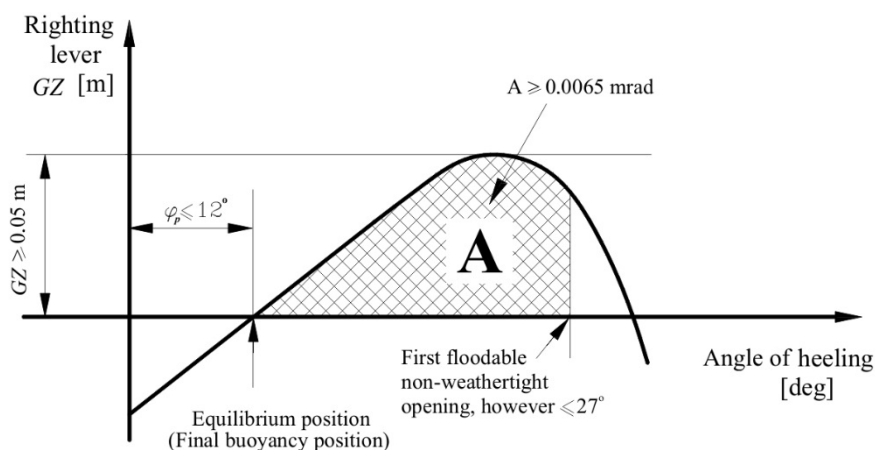

Fig. 4

- (3) If openings through which undamaged compartments may become additionally flooded are capable of being closed watertight, the closing devices shall be marked appropriately.
- (4) Where cross- or down-flooding openings are provided for reduction of unsymmetrical flooding, the time for equalisation shall not exceed 15 minutes if during the intermediate stages of flooding sufficient stability has been proved.

II.3 Requirements for Type C Tankers

II.3.1 Stability (general)

- (1) Proof of sufficient stability, including stability in damaged condition, shall be furnished.
- (2) Basic values for the stability calculation – the vessel's lightweight and the location of the centre of gravity – shall be determined either by means of an inclining experiment or by detailed mass and moment calculation. In the latter case the lightweight shall be checked by means of a lightweight test with a resulting difference of not more than $\pm 5\%$ between the mass determined by the calculation and the displacement determined by the draught readings.

- (3) Proof of sufficient intact stability shall be furnished for all stages of loading and unloading and for the final loading condition. Floatability after damage shall be proved for the most unfavourable loading condition. For this purpose calculated proof of sufficient stability shall be established for critical intermediate stages of flooding and for the final stage of flooding. Negative values of stability in intermediate stages of flooding may be accepted only if the continued range of curve of righting lever in damaged condition indicates adequate positive values of stability.

II.3.2 Intact Stability

- (1) The requirements for intact stability resulting from the damaged stability calculation shall be fully complied with.
- (2) For vessels with cargo tanks of more than $0.70B$ in width, additional proof shall be furnished that the following stability requirements have been fulfilled:
- in the positive area of the righting lever curve up to immersion of the first non-watertight opening there shall be a righting lever (GZ) of not less than 0.10 m;
 - the surface of the positive area of the righting lever up to immersion of the first non-watertight opening and in any event up to an angle of heel $\leq 27^\circ$ shall not be less than 0.024 mrad;
 - metacentric height (GM) shall not be less than 0.10 m.

These conditions shall be fulfilled taking account of the effect of all free surfaces in tanks at all stages of loading and unloading.

- (3) The most stringent requirements of (1) and (2) is applicable to the vessel.

II.3.3 Damage Stability

- (1) The following assumptions shall be taken into consideration for the damage stability determination:
- the extent of side damage is as follows:
 - longitudinal extent: at least $0.10L_k$, however not less than 5.00 m;
 - transverse extent: 0.79 m;
 - vertical extent: from the base plane upwards without limit;
 - the extent of bottom damage is as follows:
 - longitudinal extent: at least $0.10L_k$, however not less than 5.00 m;
 - transverse extent: 3.00 m;
 - vertical extent: from the base plane 0.59 m upwards, the sump excepted.
 - any bulkheads within the damaged area shall be assumed damaged, which means that the location of bulkheads shall be so chosen as to ensure that the vessel remains buoyant after the flooding of two or more adjacent compartments in the longitudinal direction.

The following provisions apply:

- for bottom damage, adjacent athwartship compartments shall also be assumed as flooded;
- the lower edge of any non-watertight openings (e.g. doors, windows, access hatchways) shall, at the final stage of flooding, be not less than 0.10 m above the damage waterline;
- in general, permeability shall be assumed to be 95%. Where an average permeability of less than 95% is calculated for any compartment, this calculated value obtained may be used.

However, the following minimum values shall be used:

- engine rooms: 85%
- accommodation spaces 95%

- double bottoms, oil fuel tanks, ballast tanks: 0% or 95% depending on whether, according to their function, they have to be assumed as full or empty for the vessel floating at the maximum permissible draught.

For the main engine room only the one-compartment standard need be taken into account, i.e. the end bulkheads of the engine room shall be assumed as not damaged.

- (2) At the equilibrium position (final stage of flooding), the angle of heel shall not exceed 12° . Non-watertight openings shall not be flooded before reaching the equilibrium position. If such openings are immersed before that stage, the corresponding spaces shall be considered as flooded for the purpose of the stability calculation.

Positive range of the righting lever curve beyond the equilibrium position shall have a righting lever of ≥ 0.05 m in association with an area under the curve $A \geq 0.0065$ mrad. The minimum values of stability shall be satisfied up to immersion of the first non-watertight opening and in any event up to an angle of heel $\leq 27^\circ$ (whichever angle is lesser). If non-watertight openings are immersed before that stage, the corresponding spaces shall be considered as flooded for the purpose of stability calculation.

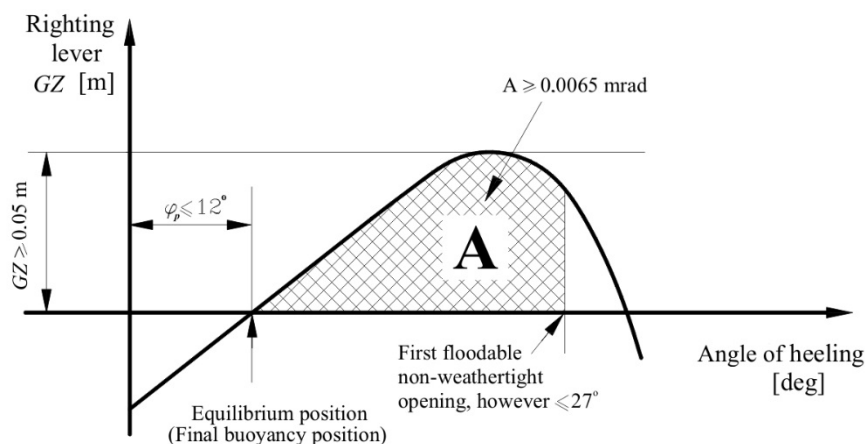

Fig. 5

- (3) If openings through which undamaged compartments may become additionally flooded are capable of being closed watertight, the closing devices shall be marked appropriately.
- (4) Where cross- or down-flooding openings are provided for reduction of unsymmetrical flooding, the time for equalisation shall not exceed 15 minutes if during the intermediate stages of flooding sufficient stability has been proved.

II.4 Requirements for Type N Tankers

II.4.1 Stability (general)

- (1) Proof of sufficient stability shall be furnished. This proof is not required for vessels with cargo tanks the width of which is not more than $0.70B$.
- (2) Basic values for the stability calculation – the vessel's lightweight and the location of the centre of gravity – shall be determined either by means of an inclining experiment or by detailed mass and moment calculation. In the latter case the lightweight shall be checked by means of a lightweight test with a resulting difference of not more than $\pm 5\%$ between the mass determined by the calculation and the displacement determined by the draught readings.
- (3) Proof of sufficient intact stability shall be furnished for all stages of loading and unloading and for the final loading condition.

II.4.2 Intact Stability

- (1) For vessels with independent cargo tanks and for double-hull constructions with cargo tanks integrated in the frames of the vessel, the requirements for intact stability resulting from the damage stability calculation shall be fully complied with.
- (2) For vessels with cargo tanks of more than $0.70B$ in width, proof shall be furnished that the following stability requirements have been fulfilled:
 - (a) in the positive area of the righting lever curve up to immersion of the first non-watertight opening there shall be a righting lever (GZ) of not less than 0.10 m;
 - (b) the surface of the positive area of the righting lever up to immersion of the first non-watertight opening and in any event up to an angle of heel $\leq 27^\circ$ shall not be less than 0.024 mrad;
 - (c) metacentric height (GM) shall not be less than 0.10 m.These conditions shall be fulfilled taking account of the effect of all free surfaces in tanks at all stages of loading and unloading.

II.4.3 Damage Stability

- (1) For vessels with independent cargo tanks and for double-hull constructions with cargo tanks integrated in the frames of the vessel, the following assumptions shall be taken into consideration for the damaged condition:
 - (a) the extent of side damage is as follows:
 - longitudinal extent: at least $0.10 L_k$, however not less than 5.00 m;
 - transverse extent: 0.59 m;
 - vertical extent: from the base line upwards without limit.
 - (b) the extent of bottom damage is as follows:
 - longitudinal extent: at least $0.10 L_k$, but not less than 5.00 m;
 - transverse extent: 3.00 m;
 - vertical extent: from the base line 0.49 m upwards, the sump excepted.
 - (c) any bulkheads within the damaged area shall be assumed damaged, which means that the location of bulkheads shall be so chosen as to ensure that the vessel remains buoyant after the flooding of two or more adjacent compartments in the longitudinal direction.

The following provisions apply:

- for bottom damage, adjacent athwartship compartments shall also be assumed as flooded;
- the lower edge of any non-watertight openings (e.g. doors, windows, access hatchways) shall, at the final stage of flooding, be not less than 0.10 m above the damage waterline;
- in general, permeability shall be assumed to be 95%. Where an average permeability of less than 95% is calculated for any compartment, this calculated value obtained may be used.

However, the following minimum values shall be used:

- engine rooms: 85%;
- accommodation: 95%;
- double bottoms, oil fuel tanks, ballast tanks, etc., depending on whether, according to their function, they have to be assumed as full or empty for the vessel floating at the maximum permissible draught: 0% or 95%.

For the main engine room only the one-compartment standard need be taken into account, i.e. the end bulkheads of the engine room shall be assumed as intact.

- (2) At the equilibrium position (final stage of flooding), the angle of heel shall not exceed 12° . Non-watertight openings shall not be flooded before reaching the equilibrium position. If such openings are immersed before that stage, the corresponding spaces shall be considered as flooded for the purpose of the stability calculation.

Positive range of the righting lever curve beyond the equilibrium position shall have a righting lever GZ of ≥ 0.05 m in association with an area under the curve of ≥ 0.0065 mrad. The minimum values of stability shall be satisfied up to immersion of the first non-watertight opening and in any event up to an angle of heel $\leq 27^\circ$. If non-watertight openings are immersed before that stage, the corresponding spaces shall be considered as flooded for the purposes of stability calculation.

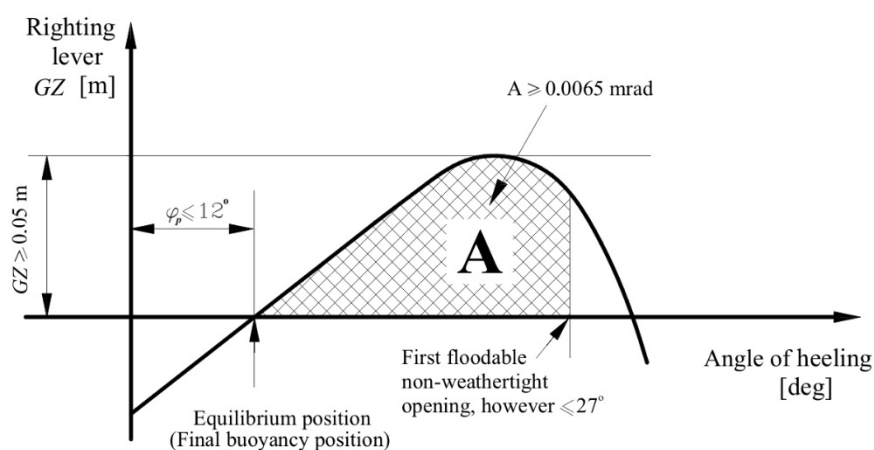

Fig. 6

- (3) If openings through which undamaged compartments may additionally become flooded are capable of being closed watertight, the closing appliances shall be marked accordingly.
- (4) Where cross- or down-flooding openings are provided for reduction of unsymmetrical flooding, the time for equalization shall not exceed 15 minutes, if during the intermediate stages of flooding sufficient stability has been proved.

ANNEX 2

SIMPLIFIED METHODS OF STABILITY CALCULATION

In the stability calculation of vessels in which the volumetric capacity of the spaces situated above the waterline is so distributed that at the heel of vessel no significant trim occurs, the following assumptions may be adopted:

- the angle of vessel downflooding may be determined with no consideration of the equivolumetric waterline in accordance with the following formula:

$$\varphi_z \cong \frac{60 \cdot (z-T)}{y} [^\circ] \quad (1)$$

where:

- z, y – co-ordinates of vessel downflooding point,
- T – current draught [m].

Angle of deck downflooding, φ_{zp} , shall be determined in accordance with the following formula:

$$\varphi_{zp} \cong \frac{120 \cdot (H-T)}{B} [^\circ] \quad (2)$$

where: H – moulded depth, [m], B – breadth of vessel [m];

- metacentric height for vessels having simplified shape may be determined in accordance with the following formula:

$$GM = 0.08 \cdot \frac{B^2}{T} + \frac{T}{2} - KG \quad [m] \quad (3)$$

where: KG – height of vessel's centre of mass in particular loading condition.

- vessel's centre of mass in particular loading condition shall be taken as follows:

$$KG = 0.75 \cdot H \quad [m] \quad (4)$$

- deck cargo centre of mass shall be taken as follows:

$$Z_{gt} = H + \frac{1}{2} h \quad [m] \quad (5)$$

where: h – maximum height of cargo above the deck [m].

- the centre of buoyancy of for vessels having simplified shape may be determined in accordance with the following formula:

$$Z_F \cong \frac{T}{2} \quad [m] \quad (6)$$

T – average draught in particular loading condition [m].

- where the curve of righting lever is unavailable, static angle of heel not exceeding 12° due to the external moment may be determined in accordance with the following formula:

$$\varphi_s = \frac{6 \cdot M}{D \cdot GM} [^\circ] \quad (7)$$

where:

- M – heeling moment, particularly due to wind pressure, M_w [kNm],
- D – moulded displacement [t],
- GM_0 – original metacentric height [m],
- φ_s – static angle of heel $[^\circ]$.

Dynamic angle of heel due to moment M , φ_0 may be determined in accordance with the following formula:

$$\varphi_0 = 2 \cdot \varphi_s = \frac{12 \cdot M}{D \cdot GM} [^\circ] \quad (8)$$

List of amendments effective as of 1 July 2019

<i>Item</i>	<i>Title/Subject</i>	<i>Source</i>
1.2	Definition of <i>Floating equipment</i> added	ES – TRIN 2017/1
3.1.2.7	Update to the requirement of heeling moment	ES – TRIN 2017/1
3.1.3.1-2	Update to the requirement of concentration of passengers	ES – TRIN 2017/1
3.1.3.1-3	Update to the requirement of standing person's centre of mass	ES – TRIN 2017/1
3.1.3.1-6	Update to the requirement of width of seat	ES – TRIN 2017/1
-	After point 3.1.3.1. 7 additional requirement	ES – TRIN 2017/1
3.1.3.1.2	Subpoint added	ES – TRIN 2017/1
3.1.3.2	The term "Z" has been added	ES – TRIN 2017/1
3.1.3.3	The term „Cb" has been supplemented	ES – TRIN 2017/1
3.6.5	The point has been completed (transport of not secured containers	ES – TRIN 2017/1
4.1.2	The point has been completed (calculation of final flooding condition)	ES – TRIN 2017/1
4.2.2.1	The point has been completed (calculation of final flooding condition for ships with length > 110 m)	ES – TRIN 2017/1
5.4.3	The point has been completed (minimum freeboard)	ES – TRIN 2017/1
5.4.7	The point added (safety clearance of doors and openings)	ES – TRIN 2017/1